

Specification Sheet



X3.3-G1

Fuel Optimized



Description

The X3.3 has all the strength and reliability the genset industry has come to expect from the X Series range but in a smaller, lighter and more economical package. The X3.3 features direct fuel injection, resulting in cleaner, quieter and more fuel-efficient performance. With a highly compact 4-cylinder envelope and extremely low heat rejection, the engine offers a high degree of installation flexibility.

Features

MICO direct injection in-line pump for cleaner, more efficient fuel consumption.

Parent bore block with deep, stiff crankcase and optimised rib arrangement to enhance strength and reduce noise.

12-volt electrics package, with starter, alternator and fuel solenoid.

Shallow oil pan and single spin-on oil and Fuel Filter

SAE '3/11.5' flywheel housing

Integrated Design - CoolPac products are supplied fitted with cooling package and air cleaner for a complete power package. Each component has been specifically developed and rigorously tested for G-Drive products, ensuring high performance, durability and reliability.

Service and Support - G-Drive products are backed by an uncompromising level of technical support and after sales service, delivered through a world class service network.



This engine has been designed in facilities certified to ISO9001 and manufactured in facilities certified to ISO9001 or ISO9002.

This equipment has been designed and tested to meet EU product safety regulations. Material compliance declaration is available upon request



Our energy working for you.™

©2020 Cummins Inc. | X3.3-G1 (12/20)

www.famcocorp.com

E-mail: info@famcocorp.com

@famco_group

Tel: ۰۲۱-۴۸۰۰۰۰۴۹

Fax: ۰۲۱-۴۴۹۹۴۶۴۲

تهران، کیلومتر ۲۱ بزرگراه لشگری (جاده مخصوص کرج)

روبروی پالایشگاه نفت پارس، پلاک ۱۲

1500 rpm (50 Hz Ratings)

Gross engine output			Net engine output			Typical generator set output					
Standby	Prime	Base	Standby	Prime	Base	Standby (ESP)		Prime (PRP)		Base (COP)	
kWm/BHP			kWm/BHP			kWe	kVA	kWe	kVA	kWe	kVA
36/48	32/43	25/34	34/46	31/42	24/32	31	38	28	35	21	27

General Engine Data

Fuel Rating	N/A
Type	4 cycle, in-line, naturally aspirated
Bore mm	91.4 mm (3.59 in.)
Stroke mm	127 mm (5 in.)
Displacement litre	3.3 litre (205 in. ³)
Cylinder block	Cast iron, 4 cylinder
Battery charging alternator	36 amps
Starting voltage	12-volt
Fuel system	MICO Inline A-Type
Fuel filter	Spin-on fuel filters with water separator
Lube oil filter type(s)	Spin-on full flow filter
Lube oil capacity (l)	8
Flywheel dimensions	SAE 3

Coolpac Performance Data

Cooling system design	Jacket Water After cooled
Coolant ratio	50% ethylene glycol; 50% water
Coolant capacity (l)	11
Limiting ambient temp.** (°C)	50
Fan power (kWm)	1.19
Cooling system air flow (m ³ /s)**	1.76
Air cleaner type	Heavy Duty Dry replaceable element with restriction indicator

** @ 13 mm H₂O

Fuel Consumption 1500 (50 Hz)

%	kWm	BHP	L/hr	US Gal./hr
Standby Power				
100	36	48	10.4	2.7
Prime Power				
100	32	43	8.5	2.3
75	24	33	6.1	1.7
50	16	22	4.3	1.2
25	8	11	2.8	0.7
Continuous Power				
100	25	34	6.4	1.7



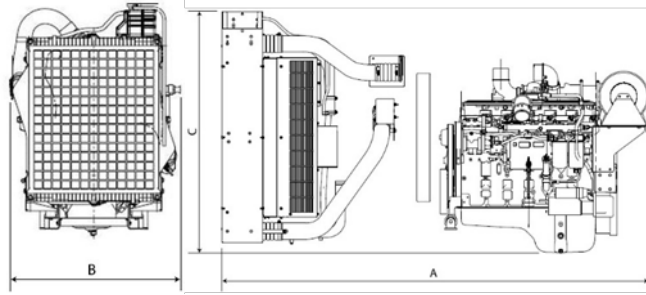

*Drawing for illustration purposes only.

Weights and Dimensions

Length mm	Width mm	Height mm	Weight (dry) kg
1123.29	712.4	841.1	269

Ratings Definitions

Emergency Standby Power (ESP):	Limited-Time Running Power (LTP):	Prime Power (PRP):	Base Load (Continuous) Power (COP):
Applicable for supplying power to varying electrical load for the duration of power interruption of a reliable utility source. Emergency Standby Power (ESP) is in accordance with ISO 8528. Fuel Stop power in accordance with ISO 3046, AS 2789, DIN 6271 and BS 5514.	Applicable for supplying power to a constant electrical load for limited hours. Limited-Time Running Power (LTP) is in accordance with ISO 8528.	Applicable for supplying power to varying electrical load for unlimited hours. Prime Power (PRP) is in accordance with ISO 8528. Ten percent overload capability is available in accordance with ISO 3046, AS 2789, DIN 6271 and BS 5514.	Applicable for supplying power continuously to a constant electrical load for unlimited hours. Continuous Power (COP) in accordance with ISO 8528, ISO 3046, AS 2789, DIN6271 and BS 5514.

DIESEL GENERATOR
DIRECT



X1.3-G2



> Specification sheet



Our energy working for you.™

Description

The X1.3 has all the strength and reliability the industry has come to expect from Cummins Inc., but in a smaller, lighter and more economical package. The X1.3 features direct fuel injection, resulting in cleaner quieter and more fuel efficient performance. The CoolPac system offers a cost effective, fully warranted, high ambient, integrated system solution capable of meeting our customers application requirements.



This engine has been built to comply with CE certification.



This engine has been designed in facilities certified to ISO9001 and manufactured in facilities certified to ISO9001 or ISO9002.

Features

The X1.3 engine is built to last, with a cast-iron block designed for durability and reliability. Design elements include:

- Bosch direct injection in-line pump for cleaner, more efficient fuel consumption.
- Heavy Duty Air Cleaner, fitted as standard.
- Parent bore block with deep, stiff crankcase and optimised rib arrangement to enhance strength and reduce noise.
- 12 volt electrics package as standard, with starter, fuel solenoid and electronic governor fitted as standard.
- Single spin-on Oil Filter and Fuel Filter
- 500 hour Service Intervals
- SAE 4/6.5 flywheel housing

Integrated Design – The X1.3 Coolpac is supplied with cooling package in kit form for OEM mounting. A heavy duty air cleaner is supplied fitted to engine to provide a complete power package. Each component has been specifically developed and rigorously tested for G-Drive products, ensuring high performance, durability and reliability.

Service and Support - G-Drive products are backed by an uncompromising level of technical support and after sales service, delivered through a world class service network.

1500 rpm (50 Hz Ratings)

Gross Engine Output			Typical Generator Set Output					
Standby	Prime	Base	Standby (ESP)		Prime (PRP)		Base (COP)	
kWm (BHP)			kWe	kVA	kWe	kVA	kWe	kVA
11.8 (15.8)	10.6 (14.2)	8.3 (11.1)	8.8	11	8	10	5.6	7



General Engine Data

Type	Inline, 4 cylinder, Diesel
Bore	95mm
Stroke	91mm
Displacement	1.29litre
Cylinder Block	Alloy cast iron, in-line, 2 cylinder
Battery Charging Alternator	Not supplied.
Starting Voltage	12 Volts
Fuel System	Direct Injection
Fuel Filter	Spin-on fuels filter with water separator
Lube Oil Filter Type	Spin on full flow filter
Lube Oil Capacity	4.5 Litre
Flywheel Dimensions	SAE 4/6.5"

Coolpac Performance Data

Cooling System Design	Jacket Water Cooled
Coolant Ratio	
Coolant Capacity (l)	3
Limiting Ambient Temp.**	50degC
Fan Power (Kwm)	0.4
Cooling System Air Flow (m ³ /s)**	12.45
Air Cleaner Type	Heavy Duty (25g/CFM)

** @ 12 mm H₂O

Shipping Weight & Dimensions

Length	Width	Height	Weight (dry)
mm	mm	mm	kg
950	750	965	265

Fuel Consumption 1500 (50 Hz)

%	kWm	BHP	L/ph	US gal/ph
Standby Power				
100	11.8	15.8	3.4	0.9
Prime Power				
100	10.6	14.2	3	0.8
75	7.94	10.65	2.4	0.6
50	5.3	7.1	1.8	0.5
25	2.65	3.55	1.2	0.3
Continuous Power				
100	8.3	11.1	2.5	0.7

Ratings Definitions

Emergency Standby Power (ESP):

Applicable for supplying power to varying electrical load for the duration of power interruption of a reliable utility source. Emergency Standby Power (ESP) is in accordance with ISO 8528. Fuel Stop power in accordance with ISO 3046, AS 2789, DIN 6271 and BS 5514.

Limited-Time Running Power (LTP):

Applicable for supplying power to a constant electrical load for limited hours. Limited-Time Running Power (LTP) is in accordance with ISO 8528.

Prime Power (PRP):

Applicable for supplying power to varying electrical load for unlimited hours. Prime Power (PRP) is in accordance with ISO 8528. Ten percent overload capability is available in accordance with ISO 3046, AS 2789, DIN 6271 and BS 5514.

Base Load (Continuous) Power (COP):

Applicable for supplying power continuously to a constant electrical load for unlimited hours. Continuous Power (COP) in accordance with ISO 8528, ISO 3046, AS 2789, DIN6271 and BS 5514.

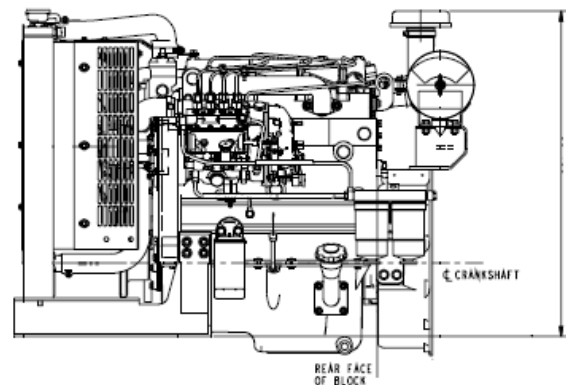

Cummins G-Drive Engines

Asia Pacific

10 Toh Guan Road
#07-01
TT International Tradepark
Singapore 608838
Phone 65 6417 2388
Fax 65 6417 2399

Europe, CIS, Middle

East and Africa
Manston Park Columbus Ave
Manston Ramsgate
Kent CT12 5BF. UK
Phone 44 1843 255000
Fax 44 1843 255902

Latin America

Rua Jati, 310, Cumbica
Guarulhos, SP 07180-900
Brazil
Phone 55 11 2186 4552
Fax 55 11 2186 4729

Mexico

Cummins S. de R.L. de C.V.
Eje 122 No. 200 Zona Industrial
San Luis Potosí, S.L.P. 78090
Mexico
Phone 52 444 870 6700
Fax 52 444 870 6811

North America

1400 73rd Avenue N.E.
Minneapolis, MN 55432
USA
Phone 1 763 574 5000
USA Toll-free 1 877 769 7669
Fax 1 763 574 5298



STAMFORD[®]

PI044E - Technical Data Sheet

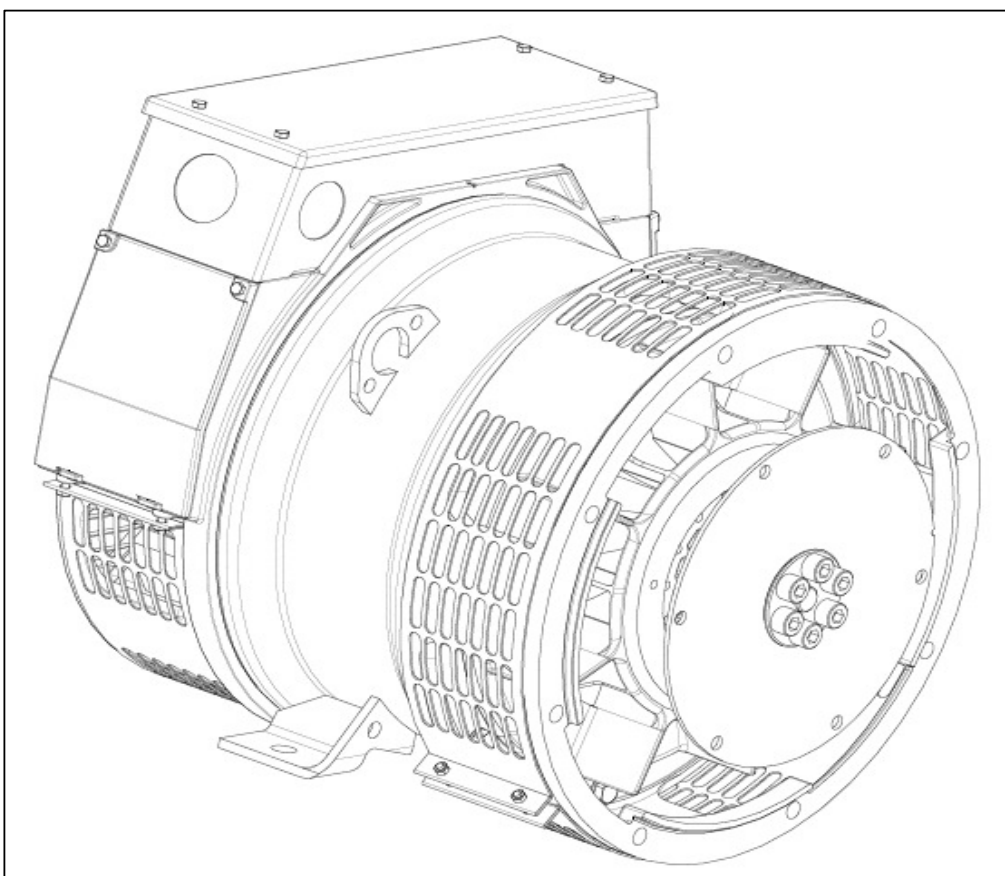

SPECIFICATIONS & OPTIONS**STANDARDS**

Stamford industrial generators meet the requirements of BS EN 60034 and the relevant section of other international standards such as BS5000, VDE 0530, NEMA MG1-32, IEC34, CSA C22.2-100, AS1359.

Other standards and certifications can be considered on request.

VOLTAGE REGULATOR**AS480 AVR fitted as STANDARD**

With this self-excited system the main stator provides power via the AVR to the exciter stator. The high efficiency semi-conductors of the AVR ensure positive build-up from initial low levels of residual voltage.

The exciter rotor output is fed to the main rotor through a three-phase full-wave bridge rectifier. The rectifier is protected by a surge suppressor against surges caused, for example, by short circuit or out-of-phase paralleling. The AS480 will support limited accessories, RFI suppression remote voltage trimmer and for the P1 range only a 'droop' Current Transformer (CT) to permit parallel operation with other ac generators.

The AVR is can be fitted to either side of the generator in its own housing in the non-drive end bracket.

Excitation Boost System (EBS) (OPTIONAL)

The EBS is a single, self-contained unit, attached to the non-drive end of the generator.

The EBS unit consists of the Excitation Boost Controller (EBC) and an Excitation Boost Generator (EBG). Under fault conditions, or when the generator is subjected to a large impact load such as a motor starting, the generator voltage will drop. The EBC senses the drop in voltage and engages the output power of the EBG. This additional power feeds the generator's excitation system, supporting the load until breaker discrimination can remove the fault or enable the generator to pick up a motor and drive the voltage recovery.

WINDINGS & ELECTRICAL PERFORMANCE

All generator stators are wound to 2/3 pitch. This eliminates triplen (3rd, 9th, 15th ...) harmonics on the voltage waveform and is found to be the optimum design for trouble-free supply of non-linear loads. The 2/3 pitch design avoids excessive neutral currents sometimes seen with higher winding pitches, when in parallel with the mains. A fully connected damper winding reduces oscillations during paralleling. This winding, with the 2/3 pitch and carefully selected pole and tooth designs, ensures very low waveform distortion.

TERMINALS & TERMINAL BOX

Standard generators are 3-phase reconnectable with 12 ends brought out to the terminals, which are mounted at the non-drive end of the generator. Dedicated single phase generators are also available. A sheet steel terminal box contains provides ample space for the customers' wiring and gland arrangements. Alternative terminal boxes are available for customers who want to fit additional components in the terminal box.

SHAFT & KEYS

All generator rotors are dynamically balanced to better than BS6861:Part 1 Grade 2.5 for minimum vibration in operation. Two bearing generators are balanced with a half key.

INSULATION / IMPREGNATION

The insulation system is class 'H'.

All wound components are impregnated with materials and processes designed specifically to provide the high build required for static windings and the high mechanical strength required for rotating components.

QUALITY ASSURANCE

Generators are manufactured using production procedures having a quality assurance level to BS EN ISO 9001.

The stated voltage regulation may not be maintained in the presence of certain radio transmitted signals. Any change in performance will fall within the limits of Criteria 'B' of EN 61000-6-2:2001. At no time will the steady-state voltage regulation exceed 2%.

DE RATES

All values tabulated on page 9 are subject to the following reductions

5% when air inlet filters are fitted.

3% for every 500 metres by which the operating altitude exceeds 1000 metres above mean sea level.

3% for every 5°C by which the operational ambient temperature exceeds 40°C.

Note: Requirement for operating in an ambient exceeding 60°C must be referred to the factory.

NB Continuous development of our products entitles us to change specification details without notice, therefore they must not be regarded as binding.

Front cover drawing typical of product range.

PI044E

STAMFORD

WINDING 311

CONTROL SYSTEM	STANDARD AS480 AVR (SELF EXCITED)							
VOLTAGE REGULATION	± 1.0 %							
SUSTAINED SHORT CIRCUIT	SELF EXCITED MACHINES DO NOT SUSTAIN A SHORT CIRCUIT CURRENT							
CONTROL SYSTEM	AS480 AVR WITH OPTIONAL EXCITATION BOOST SYSTEM (EBS)							
SUSTAINED SHORT CIRCUIT	REFER TO SHORT CIRCUIT DECREMENT CURVE (page 8)							
INSULATION SYSTEM	CLASS H							
PROTECTION	IP23							
RATED POWER FACTOR	0.8							
STATOR WINDING	DOUBLE LAYER CONCENTRIC							
WINDING PITCH	TWO THIRDS							
WINDING LEADS	12							
STATOR WDG. RESISTANCE	1.327 Ohms PER PHASE AT 22°C SERIES STAR CONNECTED							
ROTOR WDG. RESISTANCE	0.415 Ohms at 22°C							
EXCITER STATOR RESISTANCE	17.5 Ohms at 22°C							
EXCITER ROTOR RESISTANCE	0.211 Ohms PER PHASE AT 22°C							
EBS STATOR RESISTANCE	12.9 Ohms at 22°C							
R.F.I. SUPPRESSION	BS EN 61000-6-2 & BS EN 61000-6-4,VDE 0875G, VDE 0875N. refer to factory for others							
WAVEFORM DISTORTION	NO LOAD < 1.5% NON-DISTORTING BALANCED LINEAR LOAD < 5.0%							
MAXIMUM OVERSPEED	2250 Rev/Min							
BEARING DRIVE END	BALL. 6309 - 2RS. (ISO)							
BEARING NON-DRIVE END	BALL. 6306 - 2RS. (ISO)							
	1 BEARING				2 BEARING			
	WITH EBS		WITHOUT EBS		WITH EBS		WITHOUT EBS	
WEIGHT COMP. GENERATOR	80 kg		78.3 kg		83 kg		81.3 kg	
WEIGHT WOUND STATOR	27 kg		27 kg		27 kg		27 kg	
WEIGHT WOUND ROTOR	27.87 kg		26.17 kg		28.87 kg		27.17 kg	
WR ² INERTIA	0.0953 kgm ²		0.0952 kgm ²		0.097 kgm ²		0.0953 kgm ²	
SHIPPING WEIGHTS in a crate	100 kg		98.3 kg		109 kg		107.3 kg	
PACKING CRATE SIZE	71 x 51 x 67 (cm)				71 x 51 x 67 (cm)			
	50 Hz				60 Hz			
TELEPHONE INTERFERENCE	THF<2%				TIF<50			
COOLING AIR	0.110 m ³ /sec 233cfm				0.135 m ³ /sec 286 cfm			
VOLTAGE SERIES STAR	380/220	400/231	415/240	440/254	416/240	440/254	460/266	480/277
VOLTAGE PARALLEL STAR	190/110	200/115	208/120	220/127	208/120	220/127	230/133	240/138
VOLTAGE SERIES DELTA	220/110	230/115	240/120	254/127	240/120	254/127	266/133	277/138
kVA BASE RATING FOR REACTANCE VALUES	10	10	10	9.5	11	11.8	12.1	12.5
X _d DIR. AXIS SYNCHRONOUS	1.86	1.68	1.56	1.32	2.20	2.11	1.98	1.88
X' _d DIR. AXIS TRANSIENT	0.19	0.17	0.16	0.13	0.22	0.21	0.20	0.19
X'' _d DIR. AXIS SUBTRANSIENT	0.12	0.11	0.10	0.09	0.15	0.14	0.13	0.13
X _q QUAD. AXIS REACTANCE	0.89	0.80	0.74	0.63	1.06	1.02	0.95	0.90
X'' _q QUAD. AXIS SUBTRANSIENT	0.19	0.17	0.16	0.13	0.23	0.22	0.21	0.20
X _L LEAKAGE REACTANCE	0.07	0.06	0.06	0.05	0.08	0.08	0.07	0.07
X ₂ NEGATIVE SEQUENCE	0.16	0.14	0.13	0.11	0.19	0.18	0.17	0.16
X ₀ ZERO SEQUENCE	0.08	0.07	0.07	0.05	0.09	0.09	0.08	0.08
REACTANCES ARE SATURATED VALUES ARE PER UNIT AT RATING AND VOLTAGE INDICATED								
T' _d TRANSIENT TIME CONST.	0.007 s							
T'' _d SUB-TRANSTIME CONST.	0.002 s							
T' _{do} O.C. FIELD TIME CONST.	0.17 s							
T _a ARMATURE TIME CONST.	0.007 s							
SHORT CIRCUIT RATIO	1/X _d							

**50
Hz**

PI044E
Winding 311

STAMFORD

THREE PHASE EFFICIENCY CURVES

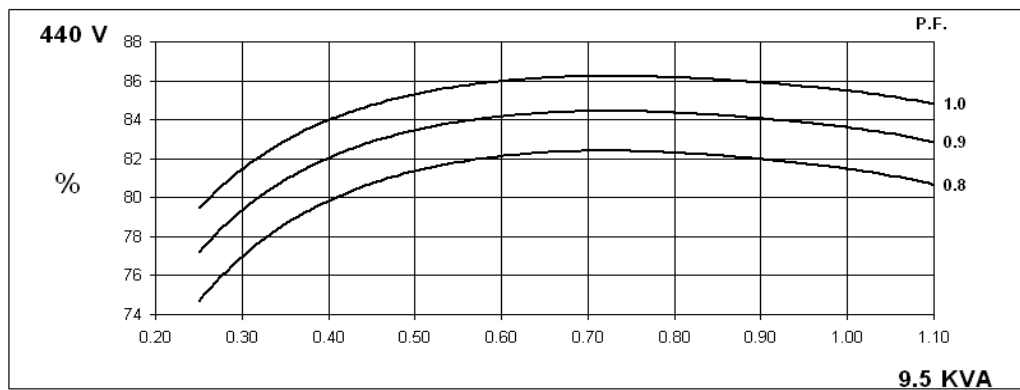
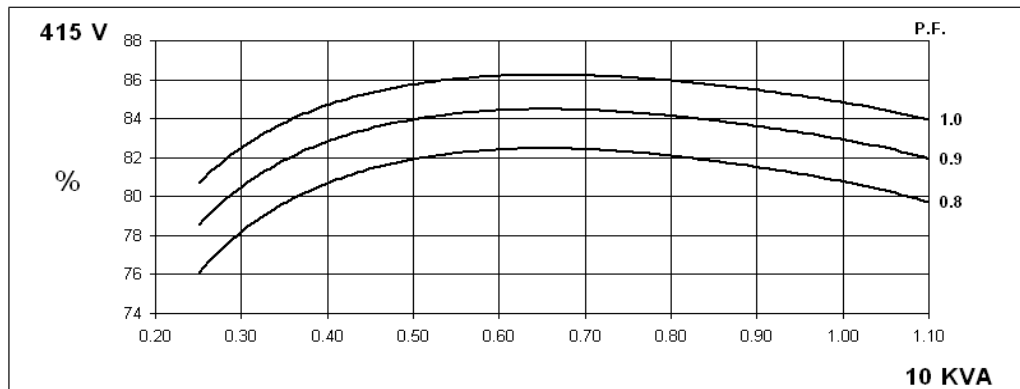
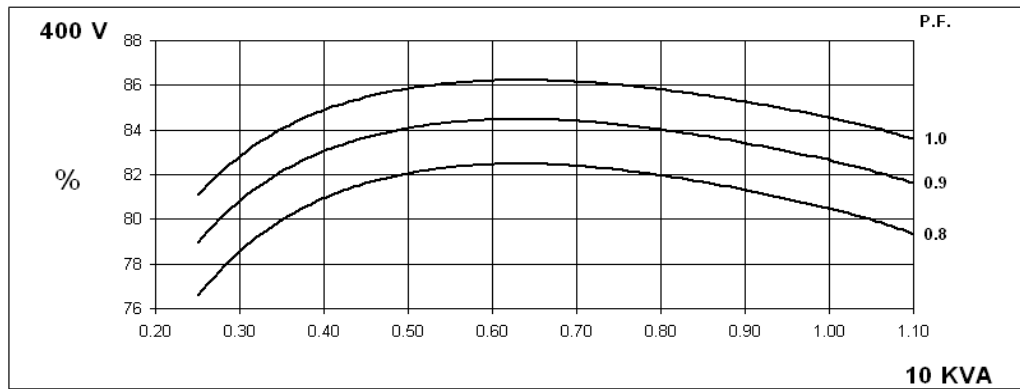
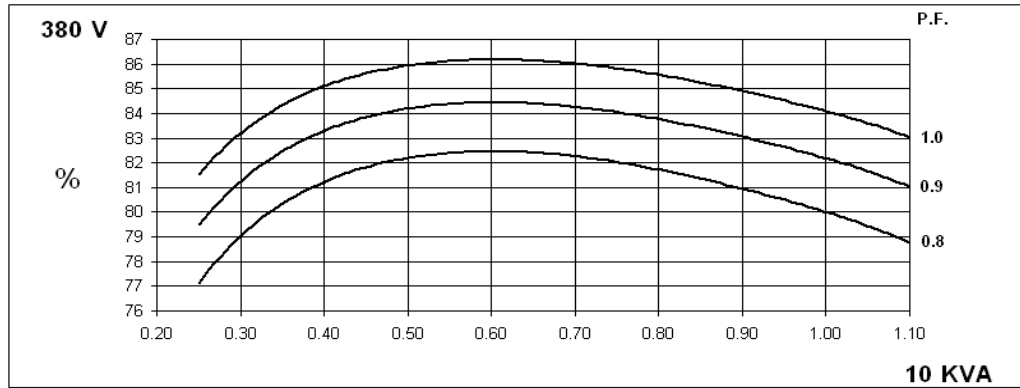

**60
Hz**

PI044E
Winding 311

STAMFORD

THREE PHASE EFFICIENCY CURVES

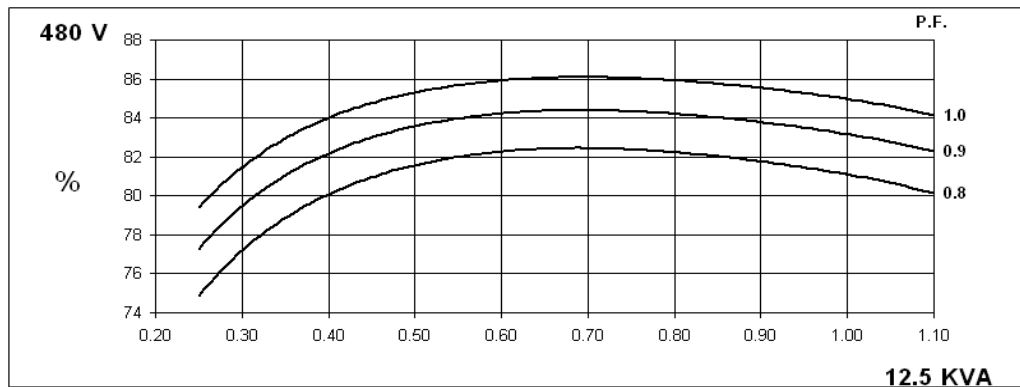
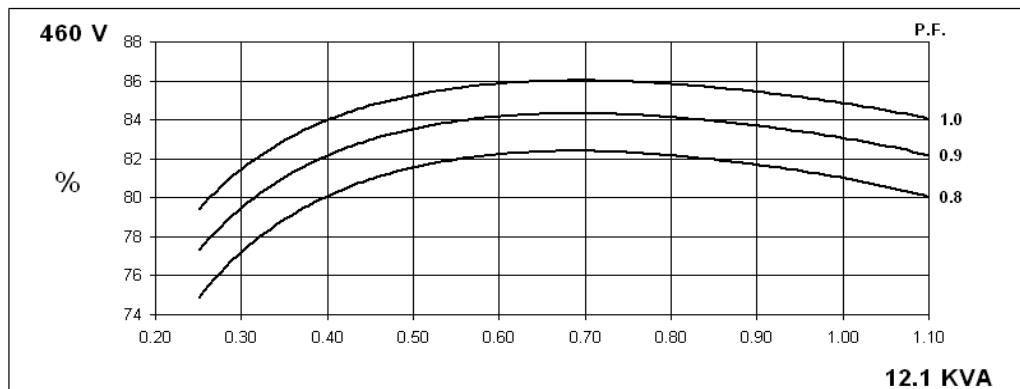
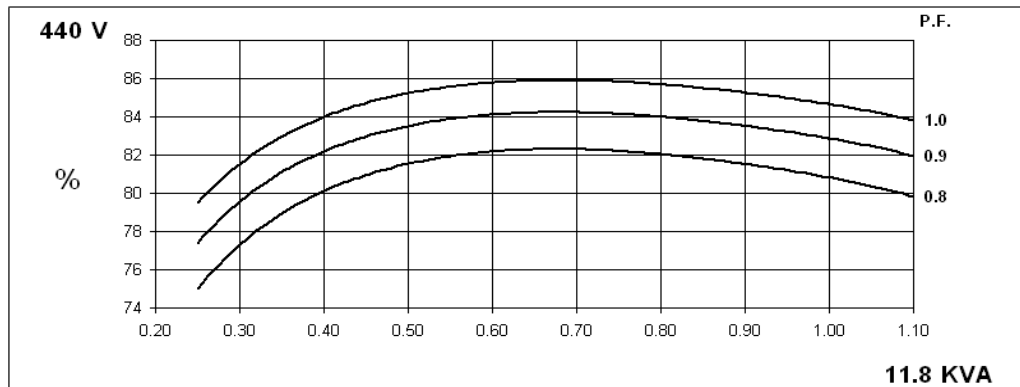
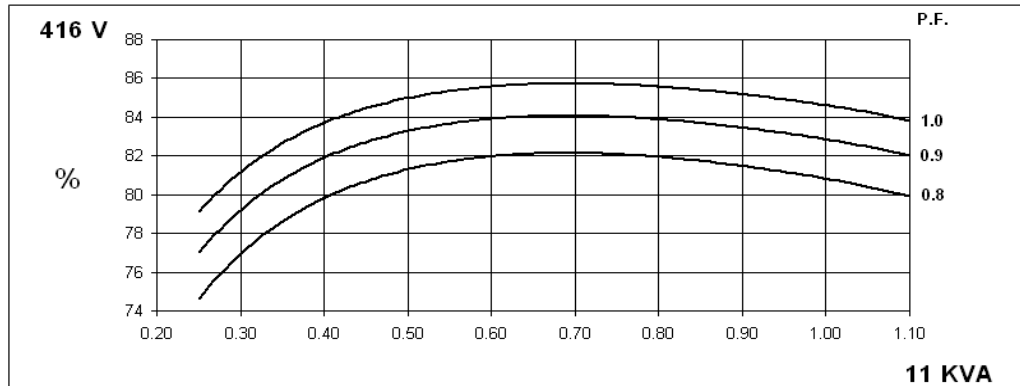

PI044E

STAMFORD

Winding 311 AS480 AVR Without EBS Locked Rotor Motor Starting Curves

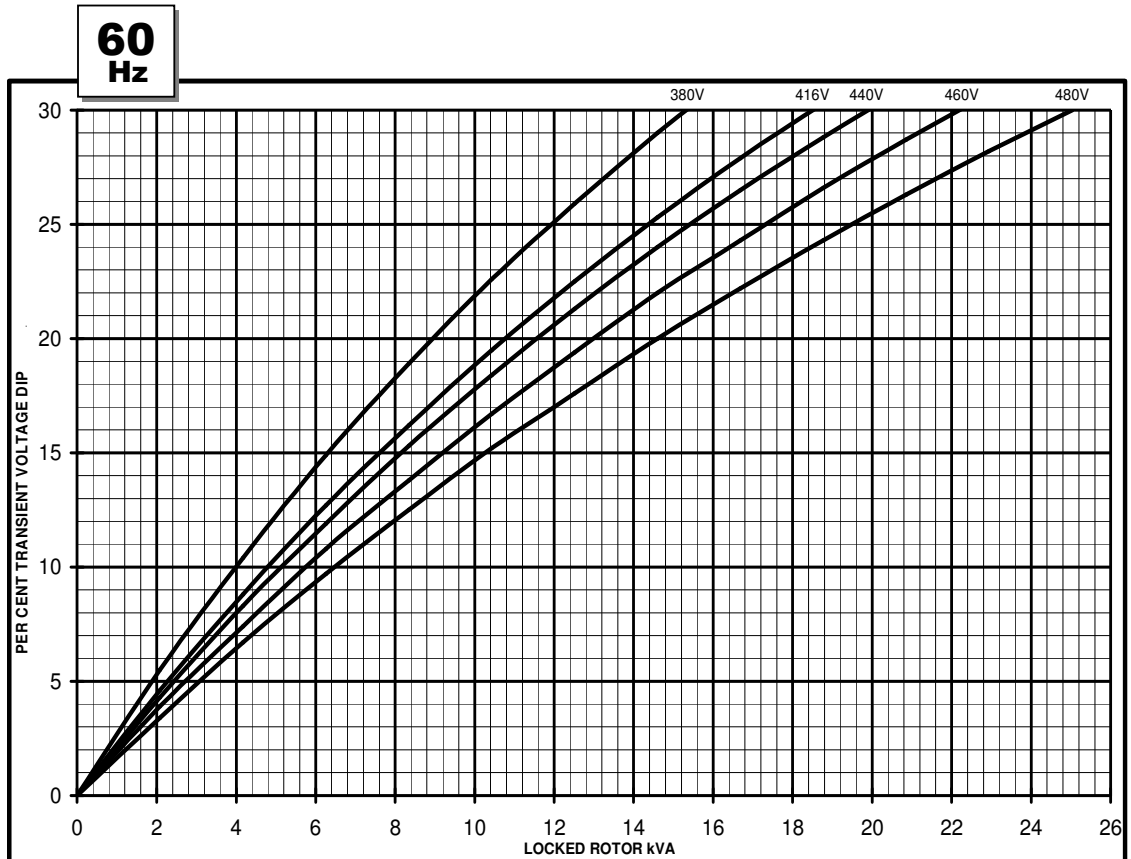
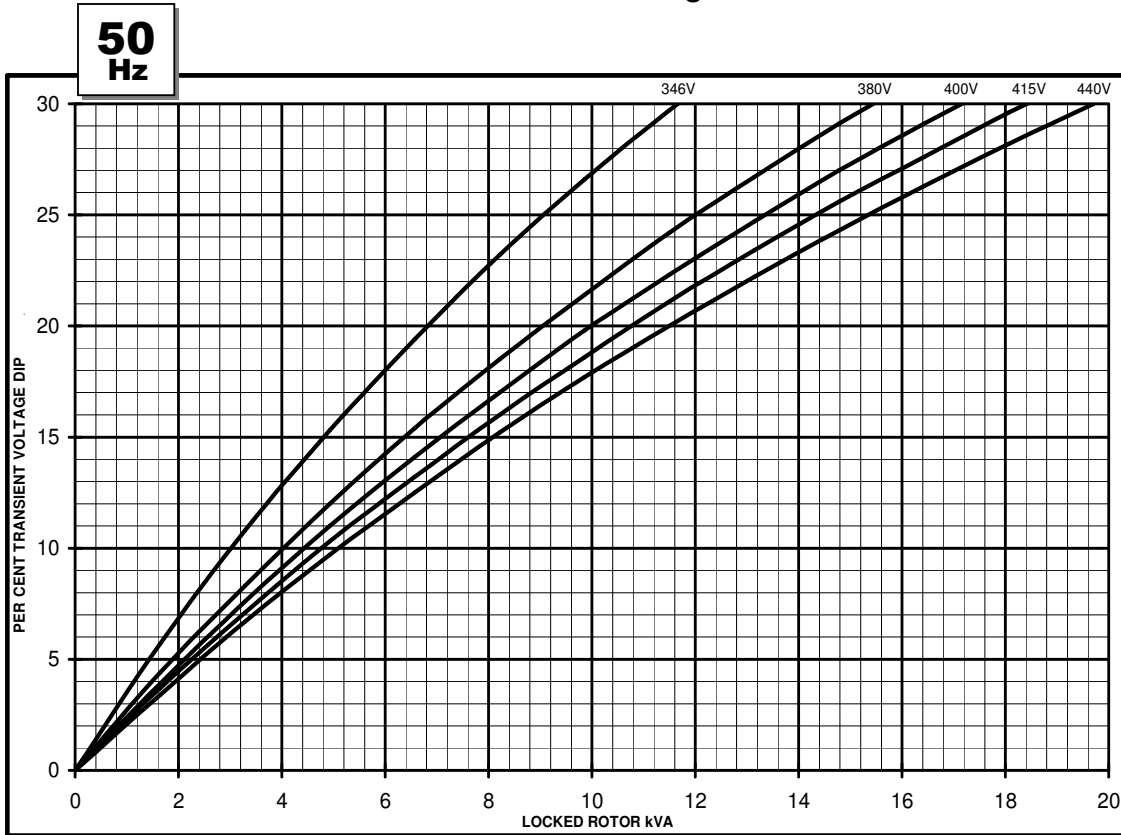

PI044E

STAMFORD

Winding 311 AS480 AVR With EBS fitted Locked Rotor Motor Starting Curves

**50
Hz**

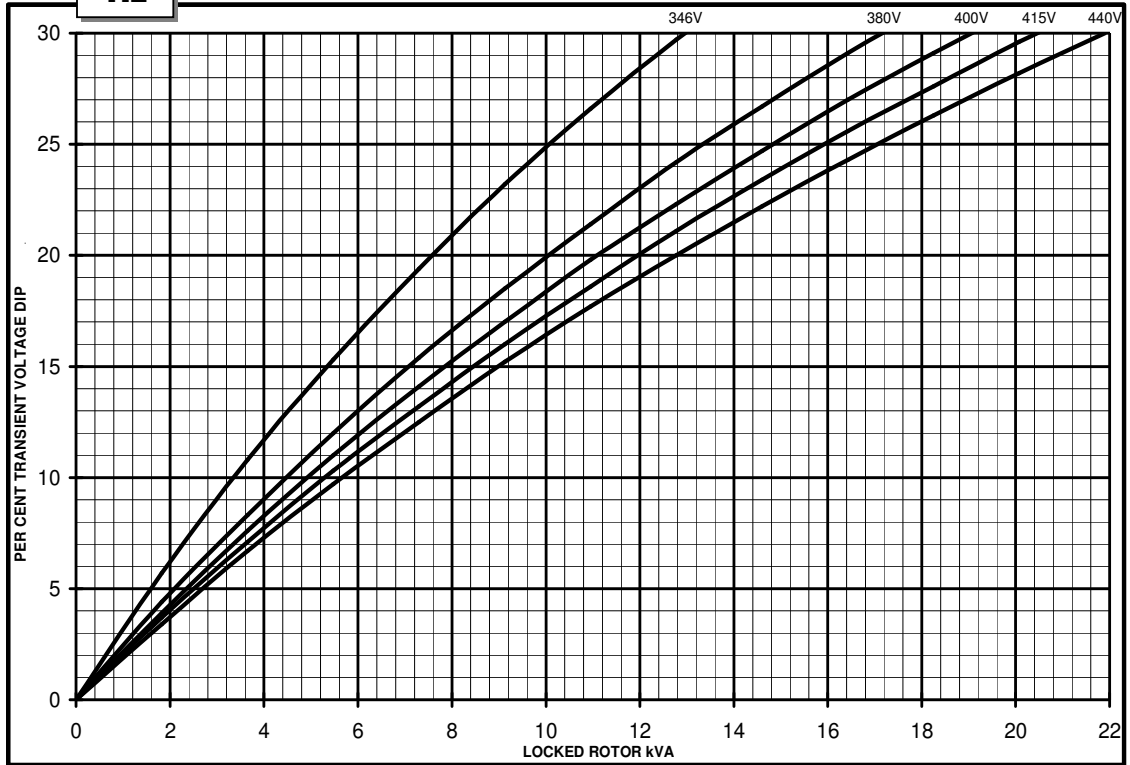

**60
Hz**

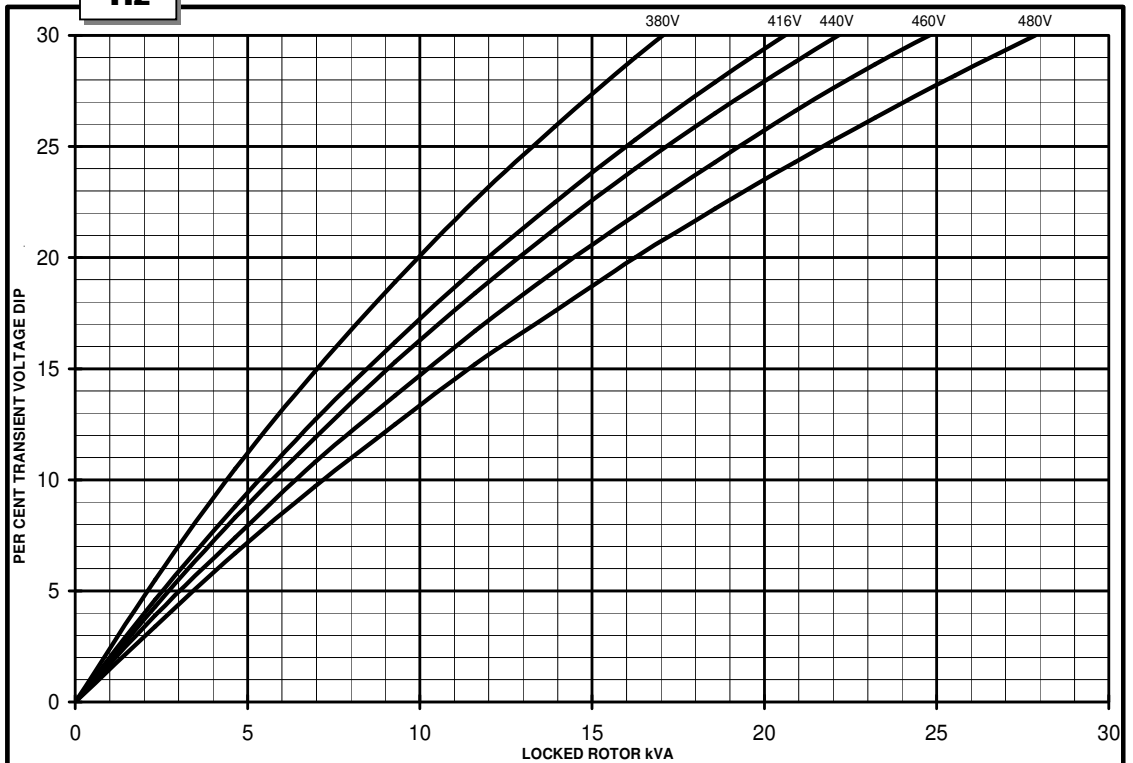

WITH EBS FITTED

**Three-phase Short Circuit Decrement Curve. No-load Excitation at Rated Speed
Based on star (wye) connection.**

**50
Hz**

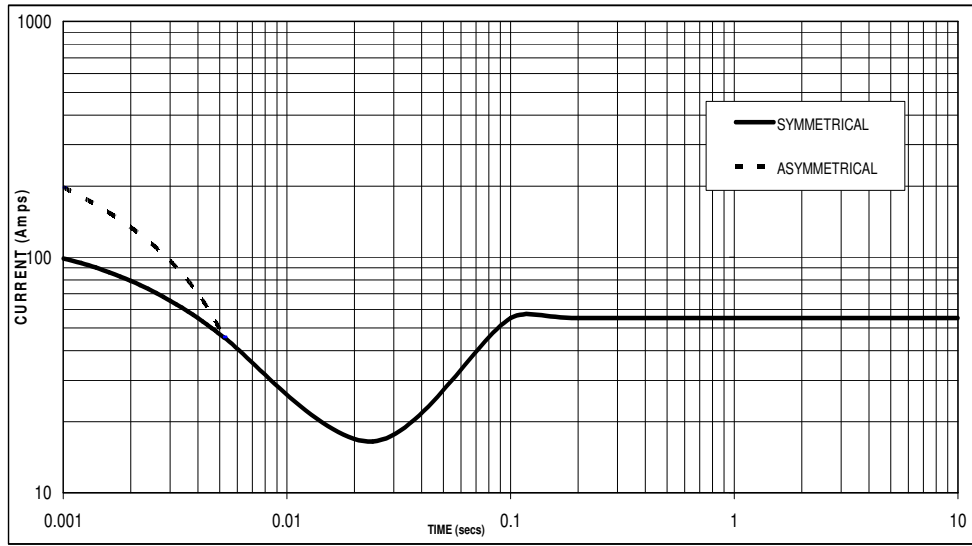

Sustained Short Circuit = 55 Amps

**60
Hz**

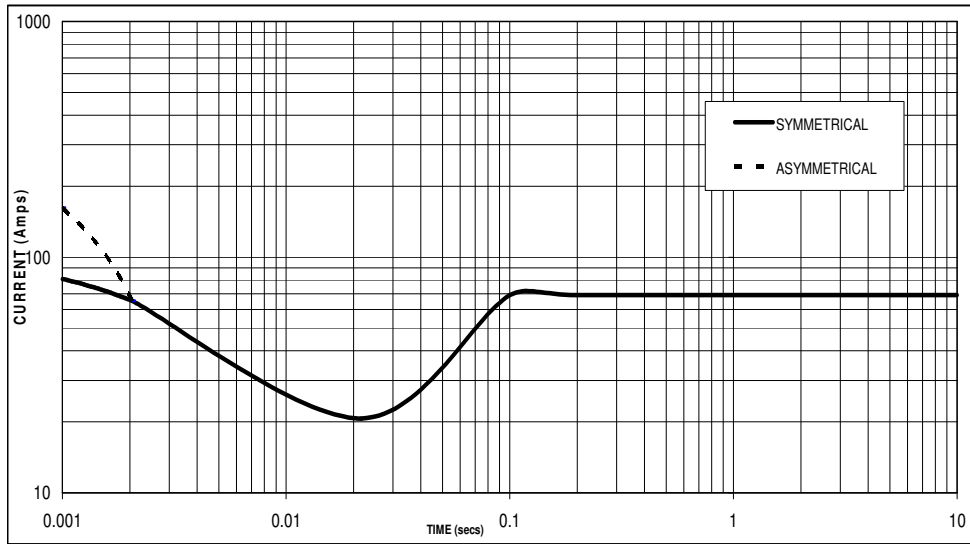

Sustained Short Circuit = 69 Amps

Note 1

The following multiplication factors should be used to adjust the values from curve between time 0.001 seconds and the minimum current point in respect of nominal operating voltage :

50Hz		60Hz	
Voltage	Factor	Voltage	Factor
380v	X 1.00	416v	X 1.00
400v	X 1.05	440v	X 1.06
415v	X 1.09	460v	X 1.10
440v	X 1.16	480v	X 1.15

The sustained current value is constant irrespective of voltage level

Note 2

The following multiplication factor should be used to convert the values calculated in accordance with NOTE 1 to those applicable to the various types of short circuit :

	3-phase	2-phase L-L	1-phase L-N
Instantaneous	x 1.00	x 0.87	x 1.30
Minimum	x 1.00	x 1.80	x 3.20
Sustained	x 1.00	x 1.50	x 2.50
Max. sustained duration	10 sec.	5 sec.	2 sec.

All other times are unchanged

Note 3

Curves are drawn for Star (Wye) connected machines. For other connection the following multipliers should be applied to current values as shown :

Parallel Star = Curve current value X 2

Series Delta = Curve current value X 1.732

PI044E

STAMFORD

Winding 311 / 0.8 Power Factor

RATINGS

Class - Temp Rise		Cont. F - 105/40°C				Cont. H - 125/40°C				Standby - 150/40°C				Standby - 163/27°C			
50 Hz	Series Star (V)	380	400	415	440	380	400	415	440	380	400	415	440	380	400	415	440
	Parallel Star (V)	190	200	208	220	190	200	208	220	190	200	208	220	190	200	208	220
	Series Delta (V)	220	230	240	254	220	230	240	254	220	230	240	254	220	230	240	254
	kVA	9.1	9.1	9.1	8.6	10.0	10.0	10.0	9.5	10.8	10.8	10.8	10.3	11.0	11.0	11.0	10.5
	kW	7.3	7.3	7.3	6.9	8.0	8.0	8.0	7.6	8.6	8.6	8.6	8.2	8.8	8.8	8.8	8.4
	Efficiency (%)	80.9	81.3	81.5	82.0	80.0	80.5	80.8	81.5	79.1	79.7	80.0	80.9	78.8	79.4	79.8	80.7
	kW Input	9.0	9.0	8.9	8.4	10.0	9.9	9.9	9.3	10.9	10.8	10.8	10.2	11.2	11.1	11.0	10.4
60 Hz	Series Star (V)	416	440	460	480	416	440	460	480	416	440	460	480	416	440	460	480
	Parallel Star (V)	208	220	230	240	208	220	230	240	208	220	230	240	208	220	230	240
	Delta (V)	240	254	266	277	240	254	266	277	240	254	266	277	240	254	266	277
	kVA	10.0	10.7	11.0	11.4	11.0	11.8	12.1	12.5	11.9	12.7	13.1	13.5	12.1	12.9	13.3	13.8
	kW	8.0	8.6	8.8	9.1	8.8	9.4	9.7	10.0	9.5	10.2	10.5	10.8	9.7	10.3	10.6	11.0
	Efficiency (%)	81.4	81.5	81.7	81.7	80.8	80.8	81.0	81.1	80.1	80.1	80.3	80.4	80.0	80.0	80.1	80.1
	kW Input	9.8	10.5	10.8	11.2	10.9	11.7	11.9	12.3	11.9	12.7	13.1	13.4	12.1	12.9	13.3	13.8

DIMENSIONS

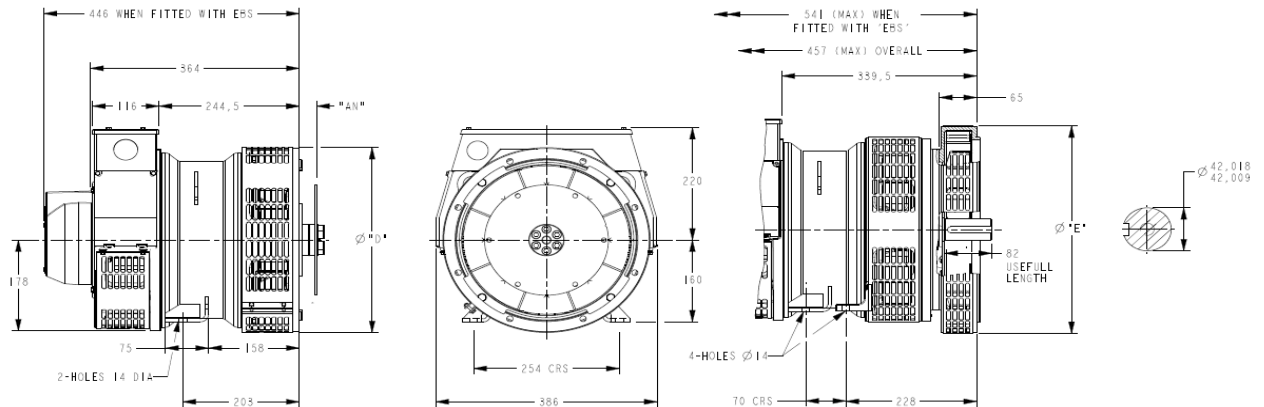

COUPLING DISC	
SAE	"AN"
6.5	30.2
7.5	30.2
8	62
10	53.8
11.5	39.6

1-BRG APARTOR	
SAE	Ø "D"
5	361
4	405
3	451
2	489

8-HOLES SPACED AS I2
8-HOLES SPACED AS I2

2-BRG APARTOR	
SAE	Ø "E"
5	359
4	406
3	455
2	493

STAMFORD

Barnack Road • Stamford • Lincolnshire • PE9 2NB
Tel: 00 44 (0)1780 484000 • Fax: 00 44 (0)1780 484100

Specification sheet



VTA28-G5

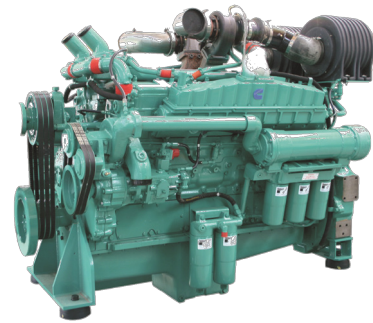

Description

The VTA28-Series benefits from years of technical development and improvement to bring customers an innovative and future proof diesel engine that keeps pace with ever changing generator set requirements.

Recognised globally for its performance under even the most severe climatic conditions, the VTA28-Series is widely acknowledged as the most robust and cost-effective diesel engine in its power range for the generator set market.

Features

Coolpac Integrated Design - Products are supplied complete with cooling package and air cleaner kit for a complete power package. Each component has been specifically developed and rigorously tested for G-Drive products, ensuring high performance, durability and reliability.

Aftercooled – Two large capacity aftercoolers result in cooler, denser intake air for more efficient combustion and reduced internal stresses for longer life.

Cylinder Block – Alloy cast iron with removable wet liners. Cross bolt support to main bearing cap provides extra strength and stability.

Fuel System – Cummins PT™ self-adjusting system. Integral dual flyweight governor provides overspeed protection independent of main governor.

Turbocharger – Two Cummins Turbo Technologies (CTT) turbochargers mounted at top of engine. Turbocharging provides more power, improved fuel economy, altitude compensation and lower smoke.

Service and Support - G-Drive products are backed by an uncompromising level of technical support and after sales service, delivered through a world class service network.

Codes and standards



This engine has been built to comply with CE certification.



This engine has been designed in facilities certified to ISO9001 and manufactured in facilities certified to ISO9001 or ISO9002.

1500 rpm (50 Hz Ratings)

Gross Engine Output			Net Engine Output			Typical Generator Set Output					
Standby	Prime	Base	Standby	Prime	Base	Standby (ESP)		Prime (PRP)		Base (COP)	
kWm/BHP			kWm/BHP			kWe	kVA	kWe	kVA	kWe	kVA
612/820	560/750	492/660	584/783	538/721	470/630	560	700	509	636	445	556

1800 rpm (60 Hz Ratings)

Gross Engine Output			Net Engine Output			Typical Generator Set Output					
Standby	Prime	Base	Standby	Prime	Base	Standby (ESP)		Prime (PRP)		Base (COP)	
kWm/BHP			kWm/BHP			kWe	kVA	kWe	kVA	kWe	kVA
671/900	608/815	504/675	630/845	574/770	470/630	600	750	545	681	442	552

General Engine Data

Type	4 cycle, in line, Turbocharged and after-cooled
Bore, mm	139.7
Stroke, mm	152.4
Displacement, Litre	28
Cylinder Block	Cast iron, 40°V 12 cylinder
Battery Charging Alternator	55A
Starting Voltage	24V
Fuel System	Direct injection
Fuel Filter	Spin on fuel filters with water separator
Lube Oil Filter Type(s)	Spin on full flow filter
Lube Oil Capacity (l)	83
Flywheel Dimensions	SAE 0

Coolpac Performance Data

Cooling System Design	Jacket Water After Cooled
Coolant Ratio	50% ethylene glycol; 50% water
Coolant Capacity (l)	126
Limiting Ambient Temp. (°C)**	50.0 (50Hz)
Fan Power (kWm)	19.6 (50Hz)
Cooling system air flow (m ³ /s)**	12.5 (50Hz)
Air Cleaner Type	Dry replaceable element with restriction indicator

** @13 mm H₂O

Weight and Dimensions

Length	Width	Height	Weight (dry)
mm	mm	mm	kg
2371	1457	2092	3215

Fuel Consumption 1500 (50 Hz)

%	kWm	BHP	L/ph	US gal/ph
Standby Power				
100	612	820	154	40.8
Prime Power				
100	560	750	140	37
75	420	563	104	27.5
50	280	375	73	19.3
25	140	188	43	11.3
Continuous Power				
100	492	660	122	32.1

Ratings Definitions

Emergency Standby Power (ESP):

Applicable for supplying power to varying electrical load for the duration of power interruption of a reliable utility source. Emergency Standby Power (ESP) is in accordance with ISO 8528. Fuel Stop power in accordance with ISO 3046, AS 2789, DIN 6271 and BS 5514.

Limited-Time Running Power (LTP):

Applicable for supplying power to a constant electrical load for limited hours. Limited-Time Running Power (LTP) is in accordance with ISO 8528.

Prime Power (PRP):

Applicable for supplying power to varying electrical load for unlimited hours. Prime Power (PRP) is in accordance with ISO 8528. Ten percent overload capability is available in accordance with ISO 3046, AS 2789, DIN 6271 and BS 5514.

Base Load (Continuous) Power (COP):

Applicable for supplying power continuously to a constant electrical load for unlimited hours. Continuous Power (COP) is in accordance with ISO 8528, ISO 3046, AS 2789, DIN6271 and BS 5514.

Fuel Consumption 1800 (60 Hz)

%	kWm	BHP	L/ph	US gal/ph
Standby Power				
100	671	900	173	45.7
Prime Power				
100	608	815	154	40.7
75	456	611	118	31.2
50	304	408	84	22.2
25	152	204	50	13.1
Continuous Power				
100	504	675	128	33.9

Cummins G-Drive Engines

Asia Pacific

10 Toh Guan Road
#07-01
TT International Tradepark
Singapore 608838
Phone 65 6417 2388
Fax 65 6417 2399

Europe, CIS, Middle East and Africa

Manston Park Columbus Ave
Manston Ramsgate
Kent CT12 5BF. UK
Phone 44 1843 255000
Fax 44 1843 255902

Latin America

Rua Jati, 310, Cumbica
Guarulhos, SP 07180-900
Brazil
Phone 55 11 2186 4552
Fax 55 11 2186 4729

Mexico

Cummins S. de R.L. de C.V.
Eje 122 No. 200 Zona Industrial
San Luis Potosí, S.L.P. 78090
Mexico
Phone 52 444 870 6700
Fax 52 444 870 6811

North America

1400 73rd Avenue N.E.
Minneapolis, MN 55432
USA
Phone 1 763 574 5000
Toll-free 1 877 769 7669
Fax 1 763 574 5298



STAMFORD[®]

HCI 534F/544F - Technical Data Sheet

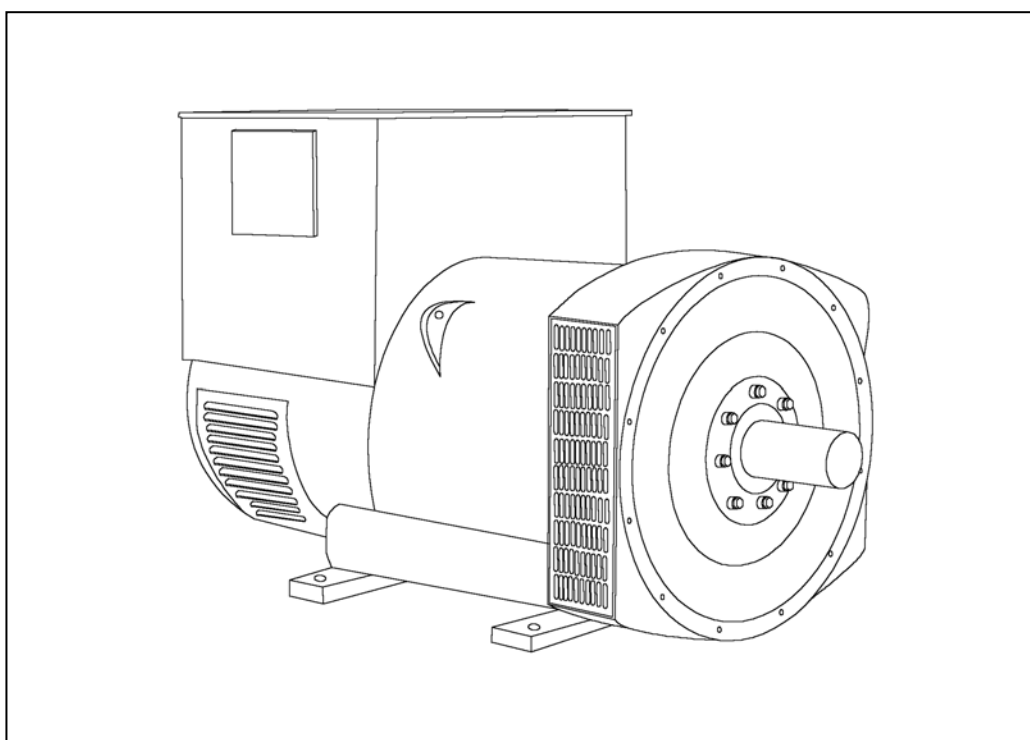

HCI534F/544F

SPECIFICATIONS & OPTIONS

STAMFORD

STANDARDS

Newage Stamford industrial generators meet the requirements of BS EN 60034 and the relevant section of other international standards such as BS5000, VDE 0530, NEMA MG1-32, IEC34, CSA C22.2-100, AS1359. Other standards and certifications can be considered on request.

VOLTAGE REGULATORS

AS440 AVR - STANDARD

With this self-excited system the main stator provides power via the Automatic Voltage Regulator (AVR) to the exciter stator. The high efficiency semi-conductors of the AVR ensure positive build-up from initial low levels of residual voltage.

The exciter rotor output is fed to the main rotor through a three-phase full-wave bridge rectifier. The rectifier is protected by a surge suppressor against surges caused, for example, by short circuit or out-of-phase paralleling.

The AS440 will support a range of electronic accessories, including a 'droop' Current Transformer (CT) to permit parallel operation with other ac generators.

MX341 AVR

This sophisticated AVR is incorporated into the Stamford Permanent Magnet Generator (PMG) control system.

The PMG provides power via the AVR to the main exciter, giving a source of constant excitation power independent of generator output. The main exciter output is then fed to the main rotor, through a full wave bridge, protected by a surge suppressor. The AVR has in-built protection against sustained over-excitation, caused by internal or external faults. This de-excites the machine after a minimum of 5 seconds.

An engine relief load acceptance feature can enable full load to be applied to the generator in a single step.

If three-phase sensing is required with the PMG system the MX321 AVR must be used.

We recommend three-phase sensing for applications with greatly unbalanced or highly non-linear loads.

MX321 AVR

The most sophisticated of all our AVRs combines all the features of the MX341 with, additionally, three-phase rms sensing, for improved regulation and performance.

Over voltage protection is built-in and short circuit current level adjustments is an optional facility.

WINDINGS & ELECTRICAL PERFORMANCE

All generator stators are wound to 2/3 pitch. This eliminates triplen (3rd, 9th, 15th ...) harmonics on the voltage waveform and is found to be the optimum design for trouble-free supply of non-linear loads. The 2/3 pitch design avoids excessive neutral currents sometimes seen with higher winding pitches, when in parallel with the mains. A fully connected damper winding reduces oscillations during paralleling. This winding, with the 2/3 pitch and carefully selected pole and tooth designs, ensures very low waveform distortion.

TERMINALS & TERMINAL BOX

Standard generators are 3-phase reconnectable with 12 ends brought out to the terminals, which are mounted on a cover at the non-drive end of the generator. A sheet steel terminal box contains the AVR and provides ample space for the customers' wiring and gland arrangements. It has removable panels for easy access.

SHAFT & KEYS

All generator rotors are dynamically balanced to better than BS6861:Part 1 Grade 2.5 for minimum vibration in operation. Two bearing generators are balanced with a half key.

INSULATION/IMPREGNATION

The insulation system is class 'H'.

All wound components are impregnated with materials and processes designed specifically to provide the high build required for static windings and the high mechanical strength required for rotating components.

QUALITY ASSURANCE

Generators are manufactured using production procedures having a quality assurance level to BS EN ISO 9001.

The stated voltage regulation may not be maintained in the presence of certain radio transmitted signals. Any change in performance will fall within the limits of Criteria 'B' of EN 61000-6-2:2001. At no time will the steady-state voltage regulation exceed 2%.

NB Continuous development of our products entitles us to change specification details without notice, therefore they must not be regarded as binding.

Front cover drawing typical of product range.

HCI534F/544F



WINDING 311

CONTROL SYSTEM	SEPARATELY EXCITED BY P.M.G.							
A.V.R.	MX321	MX341						
VOLTAGE REGULATION	± 0.5 %	± 1.0 %	With 4% ENGINE GOVERNING					
SUSTAINED SHORT CIRCUIT	REFER TO SHORT CIRCUIT DECREMENT CURVES (page 7)							
CONTROL SYSTEM	SELF EXCITED							
A.V.R.	AS440							
VOLTAGE REGULATION	± 1.0 %	With 4% ENGINE GOVERNING						
SUSTAINED SHORT CIRCUIT	SERIES 4 CONTROL DOES NOT SUSTAIN A SHORT CIRCUIT CURRENT							
INSULATION SYSTEM	CLASS H							
PROTECTION	IP23							
RATED POWER FACTOR	0.8							
STATOR WINDING	DOUBLE LAYER LAP							
WINDING PITCH	TWO THIRDS							
WINDING LEADS	12							
STATOR WDG. RESISTANCE	0.0037 Ohms PER PHASE AT 22°C SERIES STAR CONNECTED							
ROTOR WDG. RESISTANCE	2.16 Ohms at 22°C							
EXCITER STATOR RESISTANCE	17 Ohms at 22°C							
EXCITER ROTOR RESISTANCE	0.092 Ohms PER PHASE AT 22°C							
R.F.I. SUPPRESSION	BS EN 61000-6-2 & BS EN 61000-6-4, VDE 0875G, VDE 0875N. refer to factory for others							
WAVEFORM DISTORTION	NO LOAD < 1.5% NON-DISTORTING BALANCED LINEAR LOAD < 5.0%							
MAXIMUM OVERSPEED	2250 Rev/Min							
BEARING DRIVE END	BALL. 6220 (ISO)							
BEARING NON-DRIVE END	BALL. 6314 (ISO)							
	1 BEARING				2 BEARING			
WEIGHT COMP. GENERATOR	1685 kg				1694 kg			
WEIGHT WOUND STATOR	805 kg				805 kg			
WEIGHT WOUND ROTOR	684 kg				655 kg			
WR ² INERTIA	10.033 kgm ²				9.7551 kgm ²			
SHIPPING WEIGHTS in a crate	1775 kg				1780kg			
PACKING CRATE SIZE	166 x 87 x 124(cm)				166 x 87 x 124(cm)			
	50 Hz				60 Hz			
TELEPHONE INTERFERENCE	THF<2%				TIF<50			
COOLING AIR	1.035 m ³ /sec 2202 cfm				1.312 m ³ /sec 2780 cfm			
VOLTAGE SERIES STAR	380/220	400/231	415/240	440/254	416/240	440/254	460/266	480/277
VOLTAGE PARALLEL STAR	190/110	200/115	208/120	220/127	208/120	220/127	230/133	240/138
VOLTAGE SERIES DELTA	220/110	230/115	240/120	254/127	240/120	254/127	266/133	277/138
KVA BASE RATING FOR REACTANCE VALUES	670	670	670	650	738	775	800	825
X _d DIR. AXIS SYNCHRONOUS	2.90	2.62	2.43	2.10	3.33	3.13	2.95	2.80
X' _d DIR. AXIS TRANSIENT	0.16	0.14	0.13	0.11	0.16	0.15	0.14	0.13
X'' _d DIR. AXIS SUBTRANSIENT	0.11	0.10	0.09	0.08	0.11	0.10	0.10	0.09
X _q QUAD. AXIS REACTANCE	2.42	2.19	2.03	1.75	2.66	2.50	2.36	2.23
X'' _q QUAD. AXIS SUBTRANSIENT	0.25	0.23	0.21	0.18	0.31	0.29	0.27	0.26
X _L LEAKAGE REACTANCE	0.05	0.04	0.04	0.03	0.05	0.05	0.04	0.04
X ₂ NEGATIVE SEQUENCE	0.18	0.16	0.15	0.13	0.21	0.20	0.19	0.18
X ₀ ZERO SEQUENCE	0.08	0.08	0.07	0.06	0.09	0.08	0.08	0.08
REACTANCES ARE SATURATED VALUES ARE PER UNIT AT RATING AND VOLTAGE INDICATED								
T' _d TRANSIENT TIME CONST.	0.08s							
T'' _d SUB-TRANSTIME CONST.	0.012s							
T' _{do} O.C. FIELD TIME CONST.	2.5s							
T _a ARMATURE TIME CONST.	0.019s							
SHORT CIRCUIT RATIO	1/X _d							

50
Hz

HCI534F/544F
Winding 311

STAMFORD

THREE PHASE EFFICIENCY CURVES

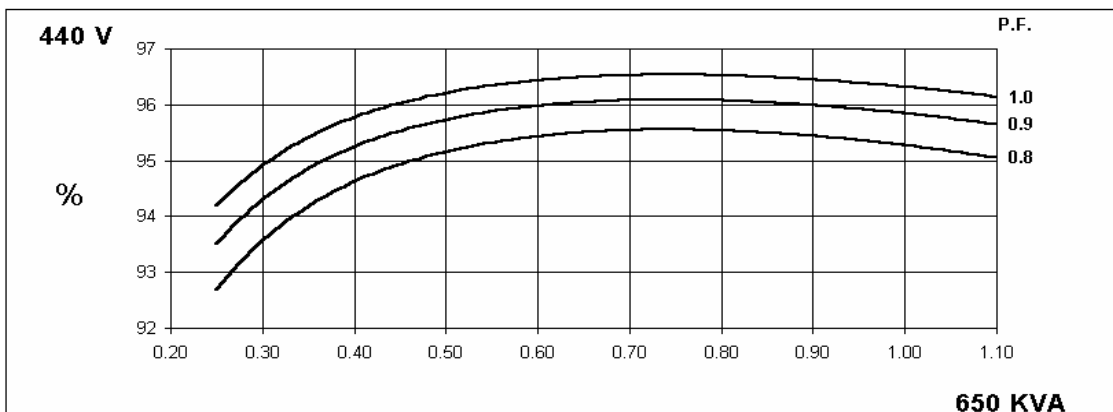
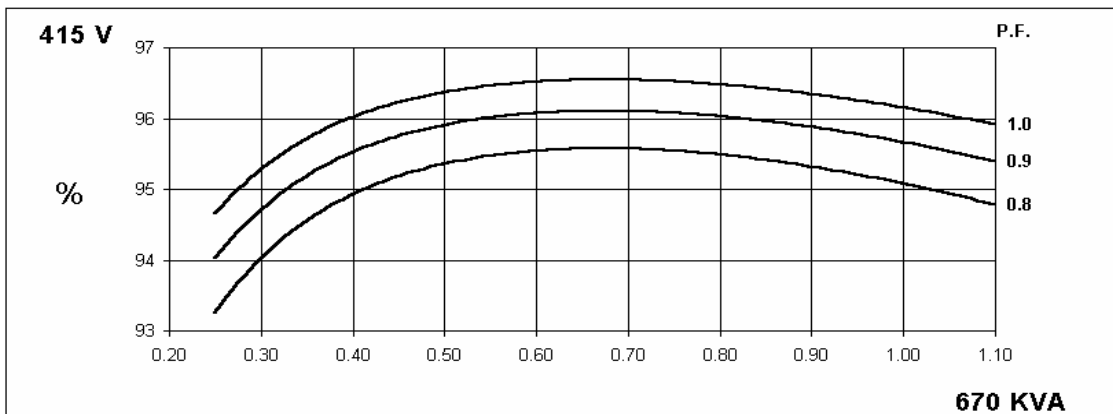
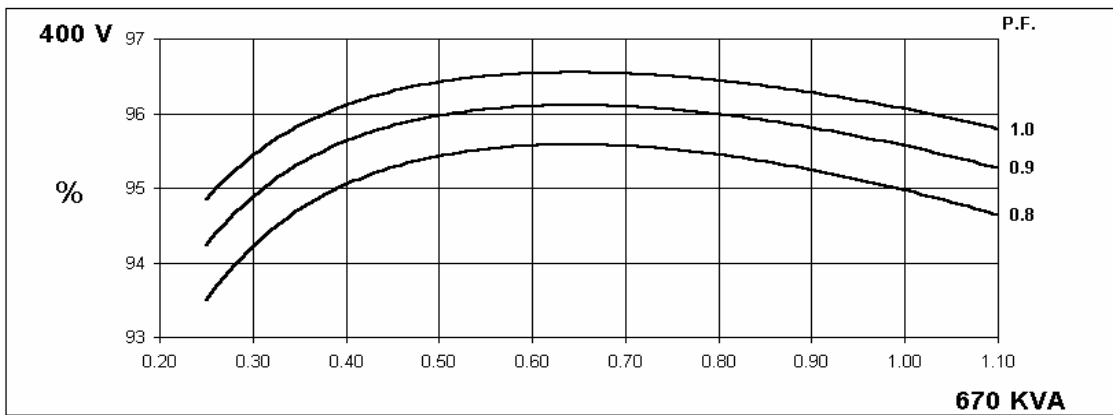
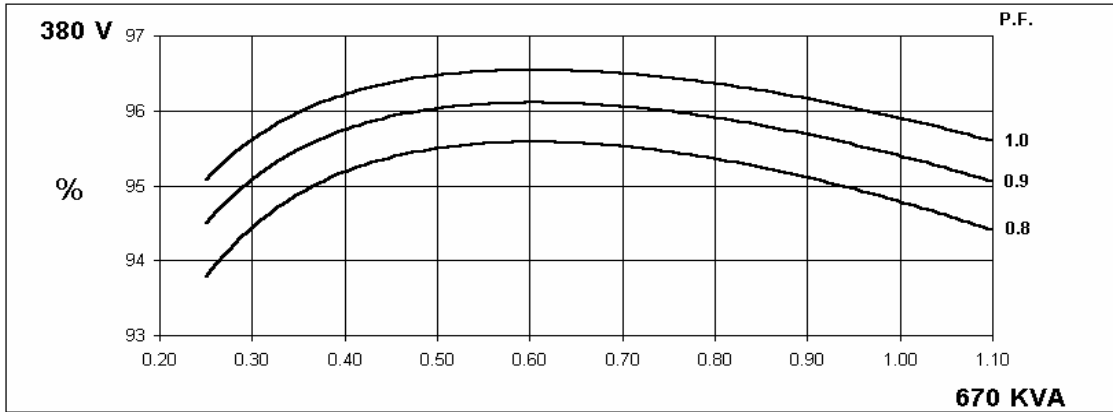

60
Hz

HCI534F/544F
Winding 311

STAMFORD

THREE PHASE EFFICIENCY CURVES

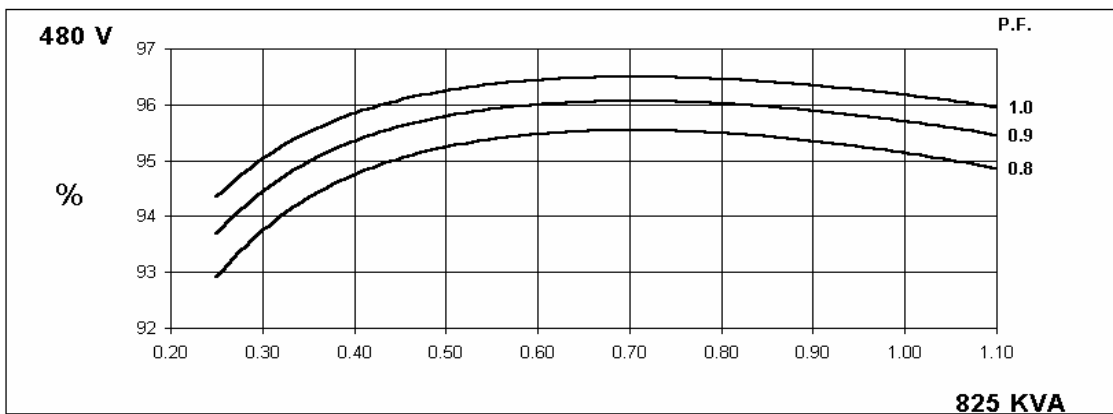
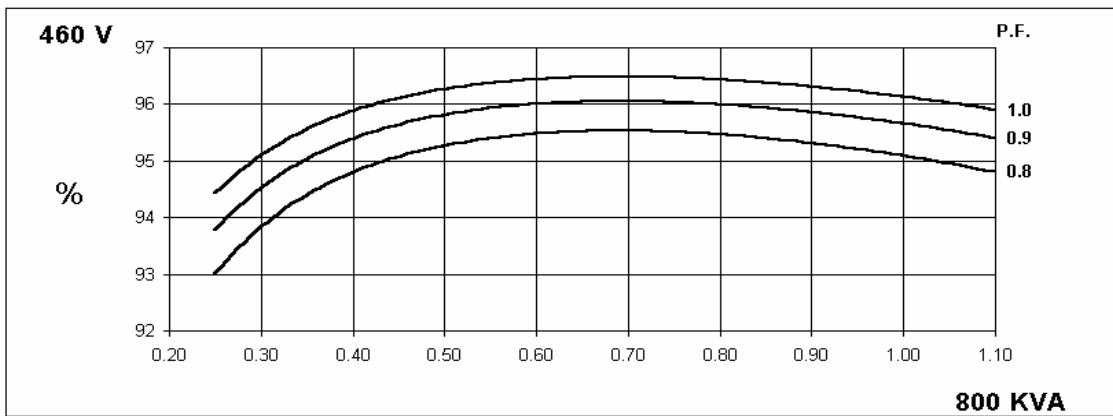
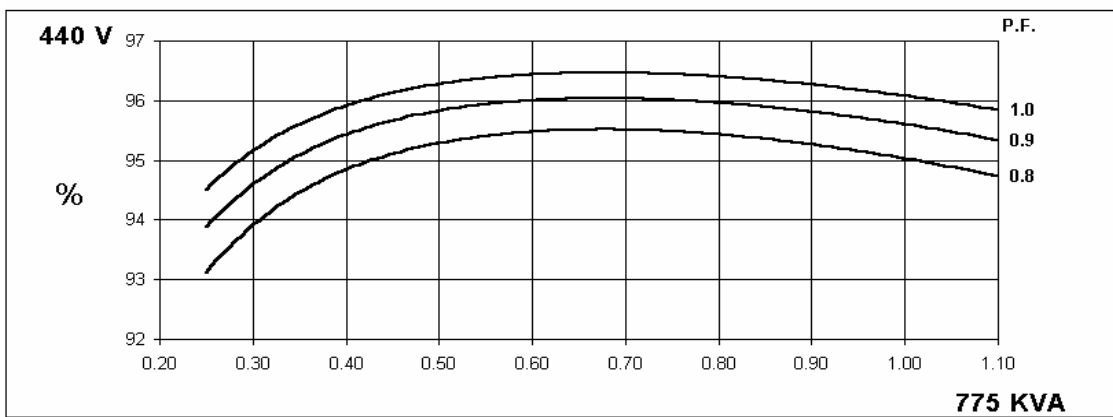
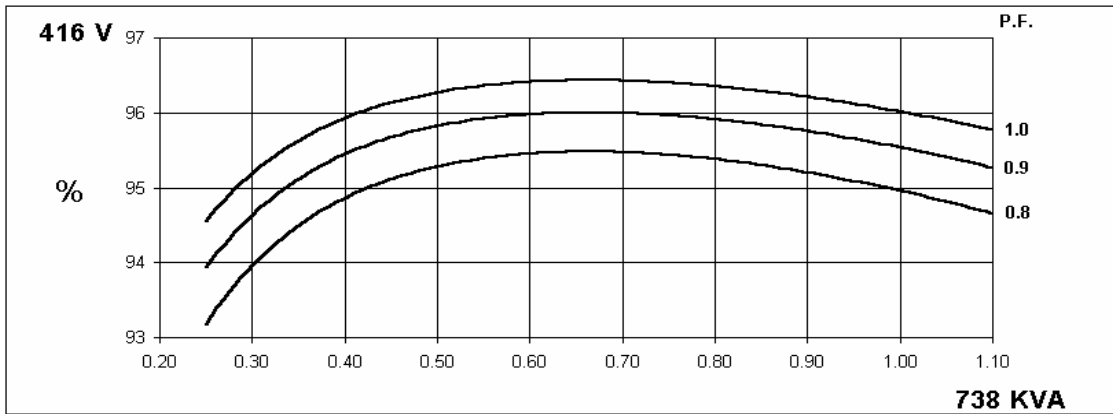

Locked Rotor Motor Starting Curve

50
Hz

MX

SX

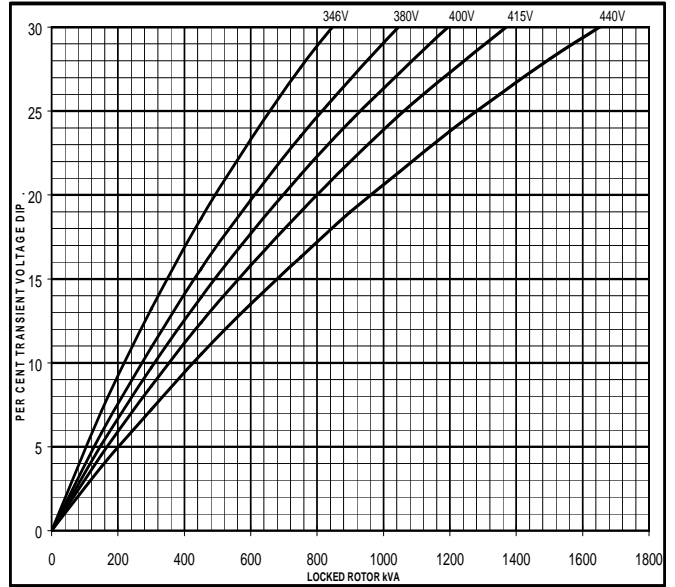
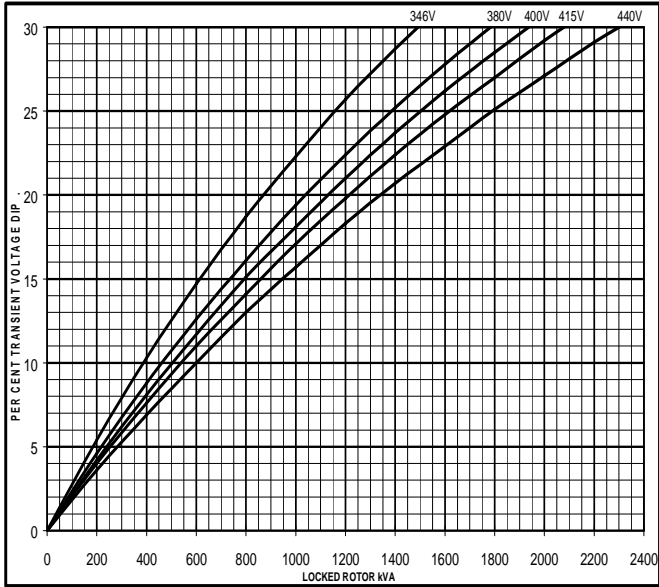

60
Hz

MX

SX

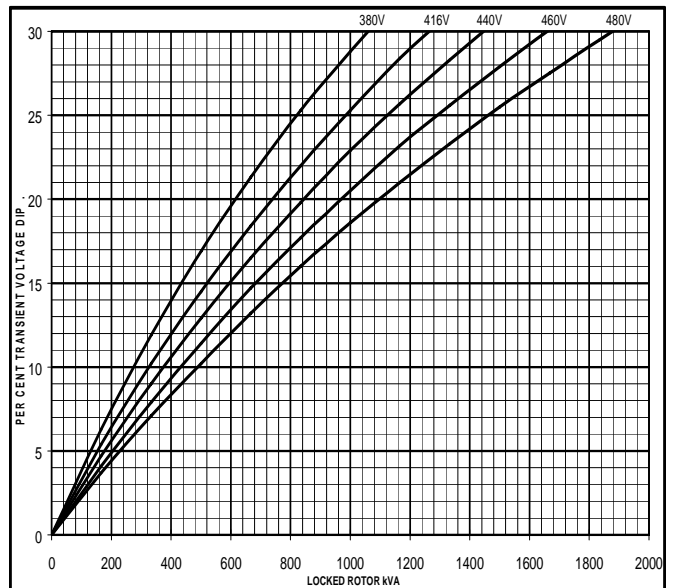
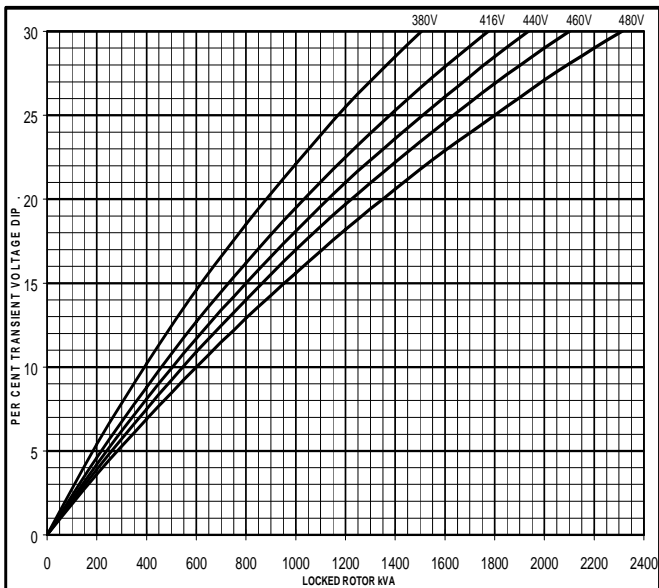

**Three-phase Short Circuit Decrement Curve. No-load Excitation at Rated Speed
Based on star (wye) connection.**

50
Hz

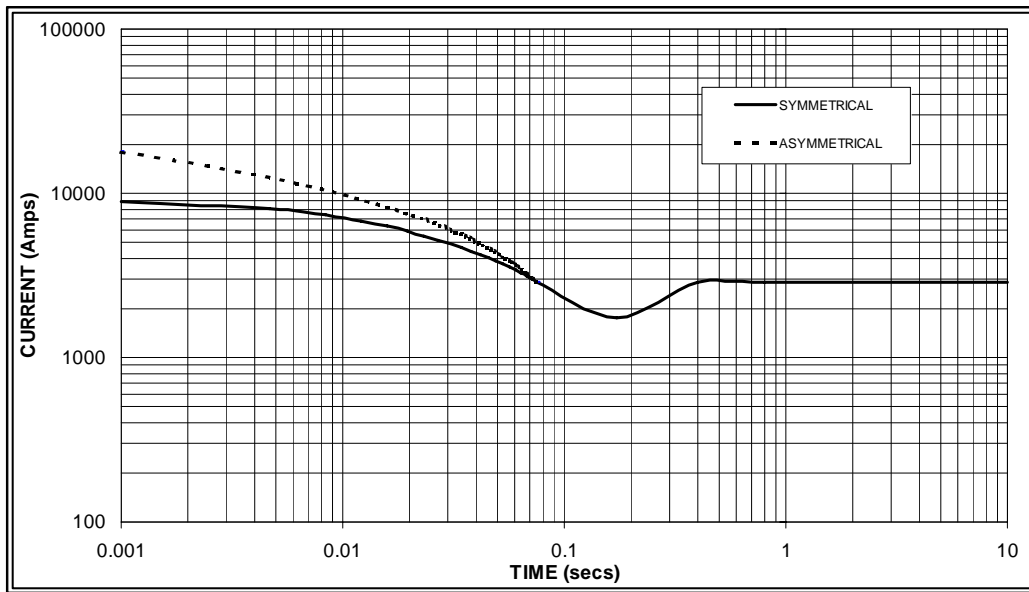

Sustained Short Circuit = 2,900 Amps

60
Hz

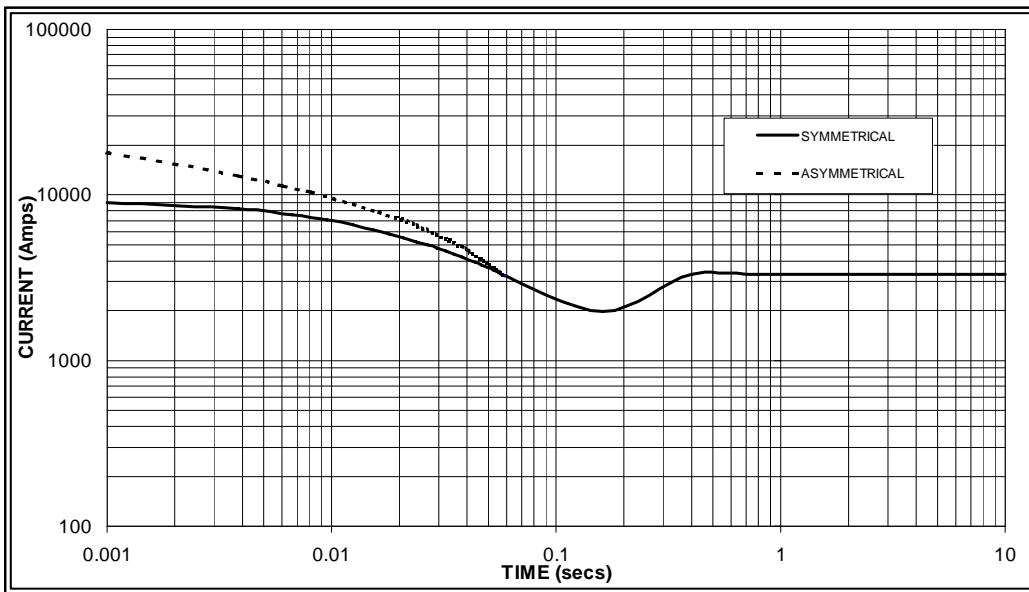

Sustained Short Circuit = 3,300 Amps

Note 1

The following multiplication factors should be used to adjust the values from curve between time 0.001 seconds and the minimum current point in respect of nominal operating voltage :

50Hz		60Hz	
Voltage	Factor	Voltage	Factor
380v	X 1.00	416v	X 1.00
400v	X 1.06	440v	X 1.06
415v	X 1.09	460v	X 1.12
440v	X 1.12	480v	X 1.20

The sustained current value is constant irrespective of voltage level

Note 2

The following multiplication factor should be used to convert the values calculated in accordance with NOTE 1 to those applicable to the various types of short circuit :

	3-phase	2-phase L-L	1-phase L-N
Instantaneous	x 1.00	x 0.87	x 1.30
Minimum	x 1.00	x 1.80	x 3.20
Sustained	x 1.00	x 1.50	x 2.50
Max. sustained duration	10 sec.	5 sec.	2 sec.

All other times are unchanged

Note 3

Curves are drawn for Star (Wye) connected machines. For other connections the following multipliers should be applied to current values as shown :

Parallel Star = Curve current value X 2

Series Delta = Curve current value X 1.732

HCI534F/544F

Winding 311 0.8 Power Factor

RATINGS

Class - Temp Rise	Cont. F - 105/40°C				Cont. H - 125/40°C				Standby - 150/40°C				Standby - 163/27°C				
50 Hz	Series Star (V)	380	400	415	440	380	400	415	440	380	400	415	440	380	400	415	440
	Parallel Star (V)	190	200	208	220	190	200	208	220	190	200	208	220	190	200	208	220
	Series Delta (V)	220	230	240	254	220	230	240	254	220	230	240	254	220	230	240	254
kVA	620	620	620	600	670	670	670	650	710	710	710	690	738	738	738	715	
kW	496	496	496	480	536	536	536	520	568	568	568	552	590	590	590	572	
Efficiency (%)	95.0	95.2	95.3	95.4	94.8	95.0	95.1	95.3	94.6	94.8	94.9	95.1	94.4	94.6	94.8	95.1	
kW Input	522	521	520	503	565	564	564	546	600	599	599	580	625	624	623	601	

60 Hz	Series Star (V)	416	440	460	480	416	440	460	480	416	440	460	480	416	440	460	480
	Parallel Star (V)	208	220	230	240	208	220	230	240	208	220	230	240	208	220	230	240
	Delta (V)	240	254	266	277	240	254	266	277	240	254	266	277	240	254	266	277
kVA	688	719	731	750	738	775	800	825	781	819	848	875	806	844	878	906	
kW	550	575	585	600	590	620	640	660	625	655	678	700	645	675	702	725	
Efficiency (%)	95.1	95.2	95.3	95.3	95.0	95.0	95.1	95.1	94.8	94.9	94.9	95.0	94.7	94.8	94.8	94.9	
kW Input	579	604	614	630	621	653	673	694	659	690	715	737	681	712	741	764	

DIMENSIONS

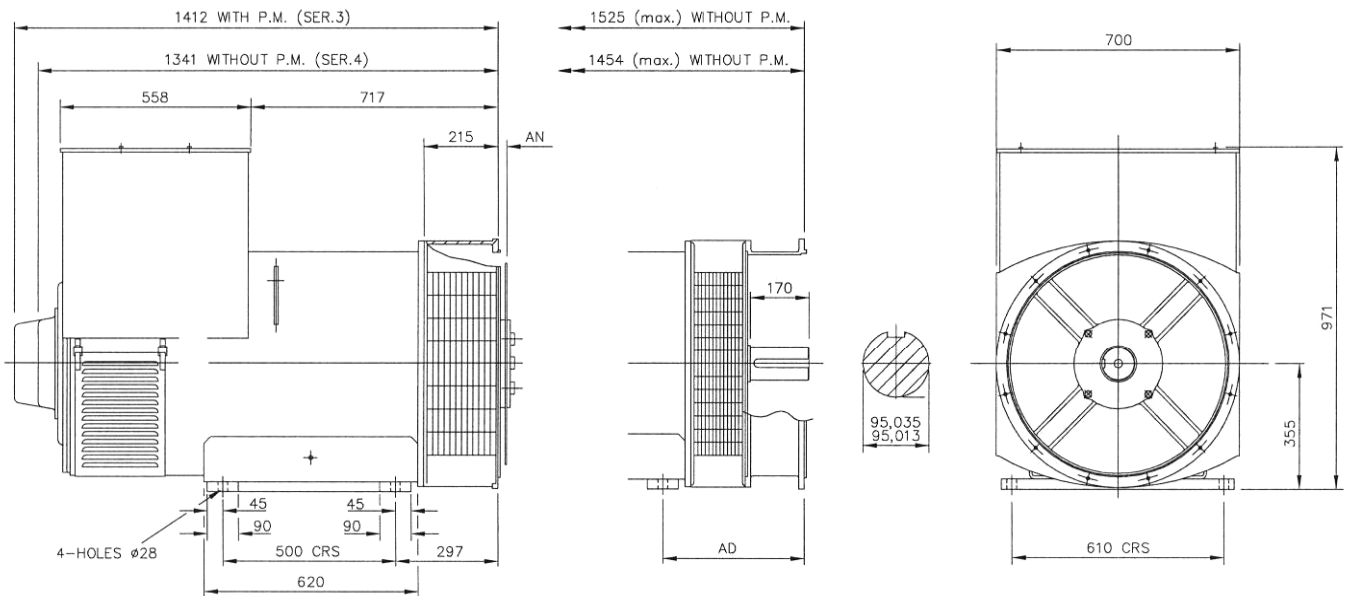

COUPLING DISC	AN
SAE 14	25,4
SAE 18	15,87
SAE 21	0

ADAPTOR	AD
SAE 00	410
SAE 0	410
SAE 1/2	390
SAE 1	390

4BT3.3-G3

Emissions Compliance:
Non-Certified or "Flex" program for EU
Mobile applications.
Formerly EU Stage2 @ 50Hz.
Unregulated Emissions @ 60Hz.

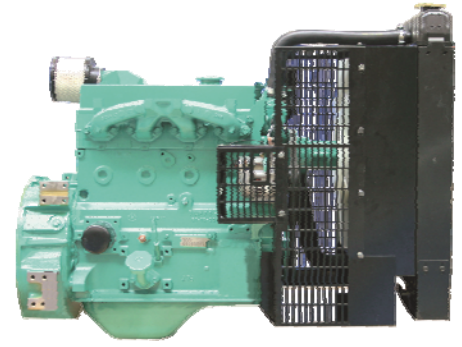

> Specification sheet



Our energy working for you.™

Description

The B3.3 has all the strength and reliability the genset industry has come to expect from the B Series range but in a smaller, lighter and more economical package. The B3.3 features direct fuel injection, resulting in cleaner, quieter and more fuel efficient performance. With a highly compact 4 cylinder envelope and extremely low heat-rejection, the engine offers a high degree of installation flexibility.



This engine has been built to comply with CE certification.



This engine has been designed in facilities certified to ISO9001 and manufactured in facilities certified to ISO9001 or ISO9002.

Features

Bosch-Zexel VE - Direct injection in-line pump for cleaner, more efficient fuel consumption.

Parent Bore Block - Deep, stiff crankcase and optimised rib arrangement to enhance strength and reduce noise.

12 volt electrics package as standard, with starter, alternator and fuel solenoid.

Minimal derate for high altitude or high ambient applications.

Shallow oil pan and single spin-on oil filter.

SAE '4' flywheel housing.

Coolpac Integrated Design - Products are supplied complete with cooling package and air cleaner kit for a complete power package. Each component has been specifically developed and rigorously tested for G-Drive products, ensuring high performance, durability and reliability.

Service and Support - G-Drive products are backed by an uncompromising level of technical support and after sales service, delivered through a world class service network.

1500 rpm (50 Hz Ratings)

Gross Engine Output			Net Engine Output			Typical Generator Set Output					
Standby	Prime	Base	Standby	Prime	Base	Standby (ESP)		Prime (PRP)		Base (COP)	
kWm/BHP			kWm/BHP			kWe	kVA	kWe	kVA	kWe	kVA
51/68	46/62	37/50	50/67	46/61	36/48	44	55	40	50	32	40

1800 rpm (60 Hz Ratings)

Gross Engine Output			Net Engine Output			Typical Generator Set Output					
Standby	Prime	Base	Standby	Prime	Base	Standby (ESP)		Prime (PRP)		Base (COP)	
kWm/BHP			kWm/BHP			kWe	kVA	kWe	kVA	kWe	kVA
60/80	54/72	43/58	59/79	53/71	42/56	50	63	45	56	36	45



General Engine Data

Type	4 cycle, in-line, turbocharged
Bore mm	95 mm (3.74 in.)
Stroke mm	115 mm (4.53 in.)
Displacement Litre	3.3 litre (199 in. ³)
Cylinder Block	Cast iron, 4 cylinder
Battery Charging Alternator	45 amps
Starting Voltage	12 volt, negative ground
Fuel System	Direct injection
Fuel Filter	Spin-on fuel filters with water separator
Lube Oil Filter Type(s)	Spin-on full flow filter
Lube Oil Capacity (l)	7.5
Flywheel Dimensions	4/11

Coolpac Performance Data

Cooling System Design	Jacket Water	
Coolant Ratio	50% ethylene glycol; 50% water	
Coolant Capacity (l)	9.1	
	50Hz (1500rpm)	60Hz (1800rpm)
Limiting Ambient Temp (°C)**	40	50
Fan Power (kWm)**	0.7	1.2
Cooling System Air Flow (m ³ /s)**	1.18	1.6
Air Cleaner Type	Dry replaceable element with restriction indicator	

** @ 13 mm H₂O

Coolpac Weight & Dimensions

Length	Width	Height	Weight (dry)
mm	mm	mm	kg
1069	625	870	299

Ratings Definitions

Emergency Standby Power (ESP):

Applicable for supplying power to varying electrical load for the duration of power interruption of a reliable utility source. Emergency Standby Power (ESP) is in accordance with ISO 8528. Fuel Stop power in accordance with ISO 3046, AS 2789, DIN 6271 and BS 5514.

Limited-Time Running Power (LTP):

Applicable for supplying power to a constant electrical load for limited hours. Limited-Time Running Power (LTP) is in accordance with ISO 8528.

Prime Power (PRP):

Applicable for supplying power to varying electrical load for unlimited hours. Prime Power (PRP) is in accordance with ISO 8528. Ten percent overload capability is available in accordance with ISO 3046, AS 2789, DIN 6271 and BS 5514.

Base Load (Continuous) Power (COP):

Applicable for supplying power continuously to a constant electrical load for unlimited hours. Continuous Power (COP) is in accordance with ISO 8528, ISO 3046, AS 2789, DIN6271 and BS 5514.

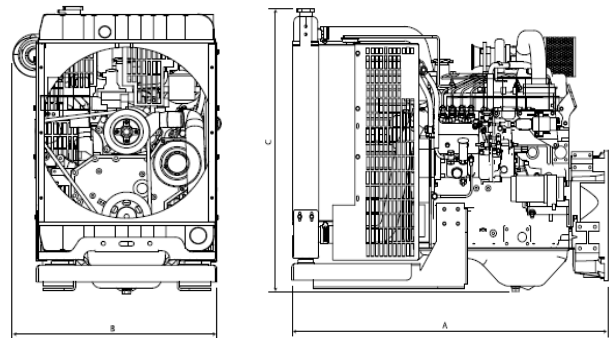

Fuel Consumption 1500 (50 Hz)

%	kWm	BHP	L/ph	US gal/ph
Standby Power				
100	51	68	13	3.4
Prime Power				
100	46	62	11	3.0

Fuel Consumption 1800 (60 Hz)

%	kWm	BHP	L/ph	US gal/ph
Standby Power				
100	60	80	15	4.0
Prime Power				
100	54	72	13	3.5

Cummins G-Drive Engines

Asia Pacific

10 Toh Guan Road
#07-01
TT International Tradepark
Singapore 608838
Phone 65 6417 2388
Fax 65 6417 2399

Europe, CIS, Middle East and Africa

Manston Park Columbus Ave
Manston Ramsgate
Kent CT12 5BF. UK
Phone 44 1843 255000
Fax 44 1843 255902

Latin America

Rua Jati, 310, Cumbica
Guarulhos, SP 07180-900
Brazil
Phone 55 11 2186 4552
Fax 55 11 2186 4729

Mexico

Cummins S. de R.L. de C.V.
Eje 122 No. 200 Zona Industrial
San Luis Potosí, S.L.P. 78090
Mexico
Phone 52 444 870 6700
Fax 52 444 870 6811

North America

1400 73rd Avenue N.E.
Minneapolis, MN 55432
USA
Phone 1 763 574 5000
USA Toll-free 1 877 769 7669
Fax 1 763 574 5298



STAMFORD®

UCI224D - Technical Data Sheet

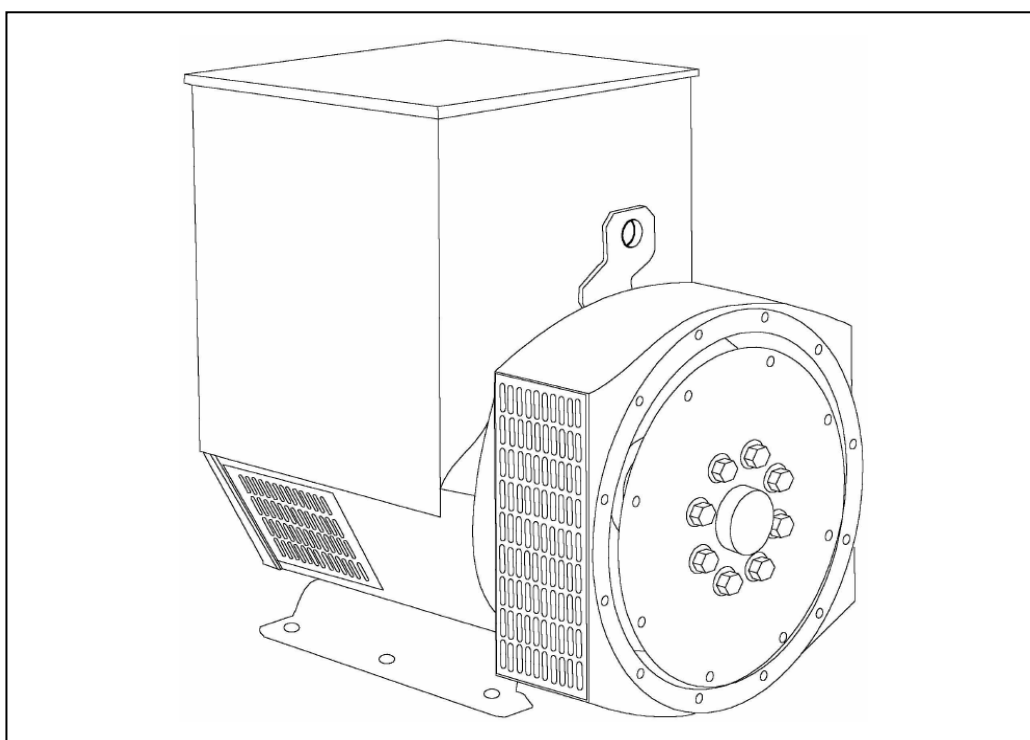

UCI224D

SPECIFICATIONS & OPTIONS

STAMFORD

STANDARDS

Newage Stamford industrial generators meet the requirements of BS EN 60034 and the relevant section of other international standards such as BS5000, VDE 0530, NEMA MG1-32, IEC34, CSA C22.2-100, AS1359. Other standards and certifications can be considered on request.

VOLTAGE REGULATORS

SX460 AVR - STANDARD

With this self excited control system the main stator supplies power via the Automatic Voltage Regulator (AVR) to the exciter stator. The high efficiency semiconductors of the AVR ensure positive build-up from initial low levels of residual voltage.

The exciter rotor output is fed to the main rotor through a three phase full wave bridge rectifier. This rectifier is protected by a surge suppressor against surges caused, for example, by short circuit.

AS440 AVR

With this self-excited system the main stator provides power via the AVR to the exciter stator. The high efficiency semi-conductors of the AVR ensure positive build-up from initial low levels of residual voltage.

The exciter rotor output is fed to the main rotor through a three-phase full-wave bridge rectifier. The rectifier is protected by a surge suppressor against surges caused, for example, by short circuit or out-of-phase paralleling.

The AS440 will support a range of electronic accessories, including a 'droop' Current Transformer (CT) to permit parallel operation with other ac generators.

MX341 AVR

This sophisticated AVR is incorporated into the Stamford Permanent Magnet Generator (PMG) control system.

The PMG provides power via the AVR to the main exciter, giving a source of constant excitation power independent of generator output. The main exciter output is then fed to the main rotor, through a full wave bridge, protected by a surge suppressor. The AVR has in-built protection against sustained over-excitation, caused by internal or external faults. This de-excites the machine after a minimum of 5 seconds.

An engine relief load acceptance feature can enable full load to be applied to the generator in a single step.

If three-phase sensing is required with the PMG system the MX321 AVR must be used.

We recommend three-phase sensing for applications with greatly unbalanced or highly non-linear loads.

MX321 AVR

The most sophisticated of all our AVRs combines all the features of the MX341 with, additionally, three-phase rms sensing, for improved regulation and performance.

Over voltage protection is built-in and short circuit current level adjustments is an optional facility.

WINDINGS & ELECTRICAL PERFORMANCE

All generator stators are wound to 2/3 pitch. This eliminates triplen (3rd, 9th, 15th ...) harmonics on the voltage waveform and is found to be the optimum design for trouble-free supply of non-linear loads. The 2/3 pitch design avoids excessive neutral currents sometimes seen with higher winding pitches, when in parallel with the mains. A fully connected damper winding reduces oscillations during paralleling. This winding, with the 2/3 pitch and carefully selected pole and tooth designs, ensures very low waveform distortion.

TERMINALS & TERMINAL BOX

Standard generators are 3-phase reconnectable with 12 ends brought out to the terminals, which are mounted on a cover at the non-drive end of the generator. A sheet steel terminal box contains the AVR and provides ample space for the customers' wiring and gland arrangements. It has removable panels for easy access.

SHAFT & KEYS

All generator rotors are dynamically balanced to better than BS6861:Part 1 Grade 2.5 for minimum vibration in operation. Two bearing generators are balanced with a half key.

INSULATION/IMPREGNATION

The insulation system is class 'H'.

All wound components are impregnated with materials and processes designed specifically to provide the high build required for static windings and the high mechanical strength required for rotating components.

QUALITY ASSURANCE

Generators are manufactured using production procedures having a quality assurance level to BS EN ISO 9001.

The stated voltage regulation may not be maintained in the presence of certain radio transmitted signals. Any change in performance will fall within the limits of Criteria 'B' of EN 61000-6-2:2001. At no time will the steady-state voltage regulation exceed 2%.

NB Continuous development of our products entitles us to change specification details without notice, therefore they must not be regarded as binding.

Front cover drawing typical of product range.

UCI224D



WINDING 311

CONTROL SYSTEM		SEPARATELY EXCITED BY P.M.G.							
A.V.R.		MX321	MX341						
VOLTAGE REGULATION		± 0.5 %	± 1.0 %	With 4% ENGINE GOVERNING					
SUSTAINED SHORT CIRCUIT		REFER TO SHORT CIRCUIT DECREMENT CURVES (page 7)							
CONTROL SYSTEM		SELF EXCITED							
A.V.R.		SX460	AS440						
VOLTAGE REGULATION		± 1.0 %	± 1.0 %	With 4% ENGINE GOVERNING					
SUSTAINED SHORT CIRCUIT		SERIES 4 CONTROL DOES NOT SUSTAIN A SHORT CIRCUIT CURRENT							
INSULATION SYSTEM		CLASS H							
PROTECTION		IP23							
RATED POWER FACTOR		0.8							
STATOR WINDING		DOUBLE LAYER CONCENTRIC							
WINDING PITCH		TWO THIRDS							
WINDING LEADS		12							
STATOR WDG. RESISTANCE		0.129 Ohms PER PHASE AT 22°C SERIES STAR CONNECTED							
ROTOR WDG. RESISTANCE		0.64 Ohms at 22°C							
EXCITER STATOR RESISTANCE		21 Ohms at 22°C							
EXCITER ROTOR RESISTANCE		0.071 Ohms PER PHASE AT 22°C							
R.F.I. SUPPRESSION		BS EN 61000-6-2 & BS EN 61000-6-4, VDE 0875G, VDE 0875N. refer to factory for others							
WAVEFORM DISTORTION		NO LOAD < 1.5% NON-DISTORTING BALANCED LINEAR LOAD < 5.0%							
MAXIMUM OVERSPEED		2250 Rev/Min							
BEARING DRIVE END		BALL. 6312-2RS (ISO)							
BEARING NON-DRIVE END		BALL. 6309-2RS (ISO)							
		1 BEARING			2 BEARING				
WEIGHT COMP. GENERATOR		285 kg			290 kg				
WEIGHT WOUND STATOR		86 kg			86 kg				
WEIGHT WOUND ROTOR		86.28 kg			77.9 kg				
WR ² INERTIA		0.4216 kgm ²			0.4198 kgm ²				
SHIPPING WEIGHTS in a crate		307 kg			311 kg				
PACKING CRATE SIZE		97 x 57 x 96(cm)			97 x 57 x 96(cm)				
		50 Hz			60 Hz				
TELEPHONE INTERFERENCE		THF<2%			TIF<50				
COOLING AIR		0.216 m ³ /sec 458 cfm			0.281 m ³ /sec 595 cfm				
VOLTAGE SERIES STAR		380/220	400/231	415/240	440/254	416/240	440/254	460/266	480/277
VOLTAGE PARALLEL STAR		190/110	200/115	208/120	220/127	208/120	220/127	230/133	240/138
VOLTAGE SERIES DELTA		220/110	230/115	240/120	254/127	240/120	254/127	266/133	277/138
KVA BASE RATING FOR REACTANCE VALUES		50	50	50	48	60	62.5	62.5	65
Xd DIR. AXIS SYNCHRONOUS		2.33	2.10	1.95	1.67	3.04	2.83	2.59	2.47
X'd DIR. AXIS TRANSIENT		0.18	0.16	0.15	0.13	0.22	0.20	0.19	0.18
X''d DIR. AXIS SUBTRANSIENT		0.12	0.11	0.10	0.09	0.15	0.14	0.13	0.12
Xq QUAD. AXIS REACTANCE		1.07	0.97	0.90	0.77	1.40	1.30	1.19	1.14
X''q QUAD. AXIS SUBTRANSIENT		0.14	0.13	0.12	0.10	0.14	0.13	0.12	0.11
X _L LEAKAGE REACTANCE		0.07	0.06	0.06	0.05	0.09	0.08	0.08	0.07
X ₂ NEGATIVE SEQUENCE		0.13	0.12	0.11	0.09	0.14	0.13	0.12	0.11
X ₀ ZERO SEQUENCE		0.08	0.08	0.07	0.06	0.09	0.08	0.08	0.07
REACTANCES ARE SATURATED		VALUES ARE PER UNIT AT RATING AND VOLTAGE INDICATED							
T'd TRANSIENT TIME CONST.		0.027 s							
T''d SUB-TRANSTIME CONST.		0.006 s							
T'do O.C. FIELD TIME CONST.		0.7 s							
T _a ARMATURE TIME CONST.		0.0055 s							
SHORT CIRCUIT RATIO		1/X _d							

50
Hz

UCI224D
Winding 311

STAMFORD

THREE PHASE EFFICIENCY CURVES

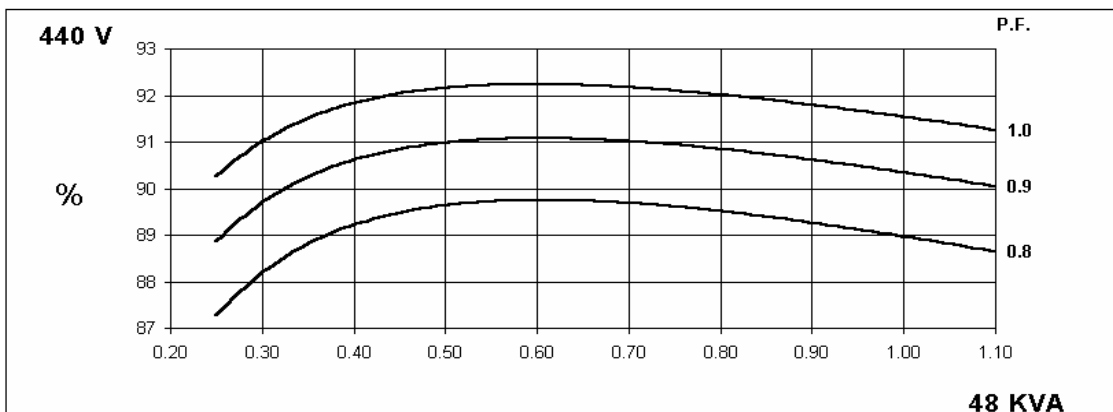
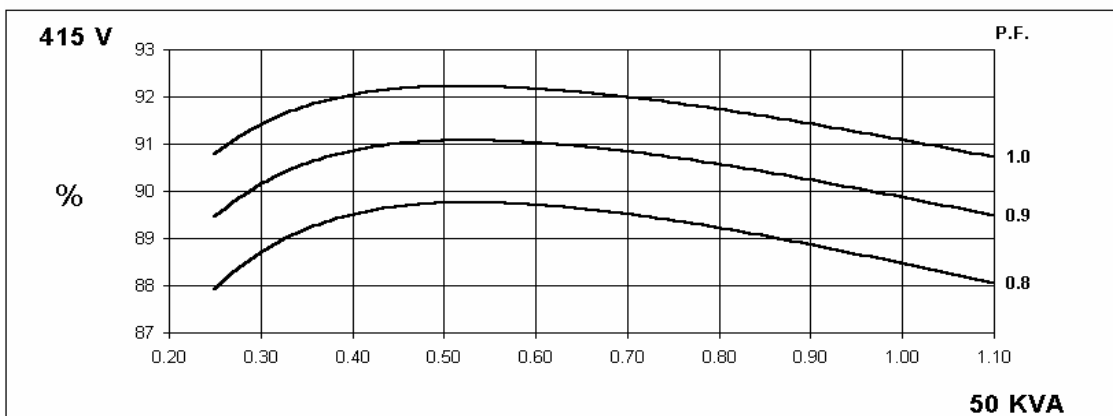
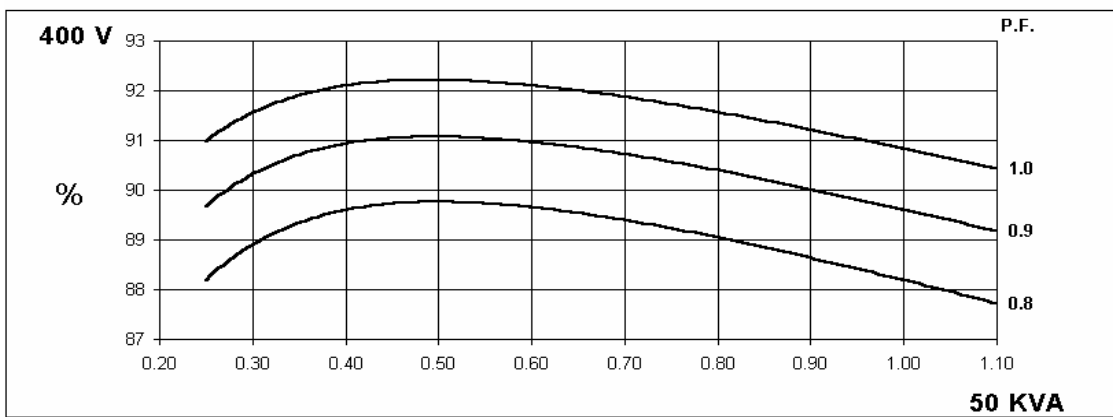
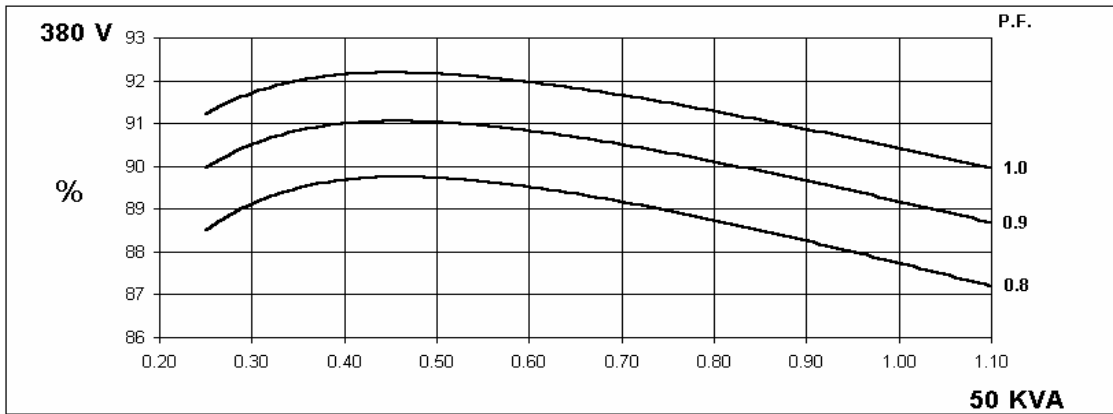

60
Hz

UCI224D
Winding 311

STAMFORD

THREE PHASE EFFICIENCY CURVES

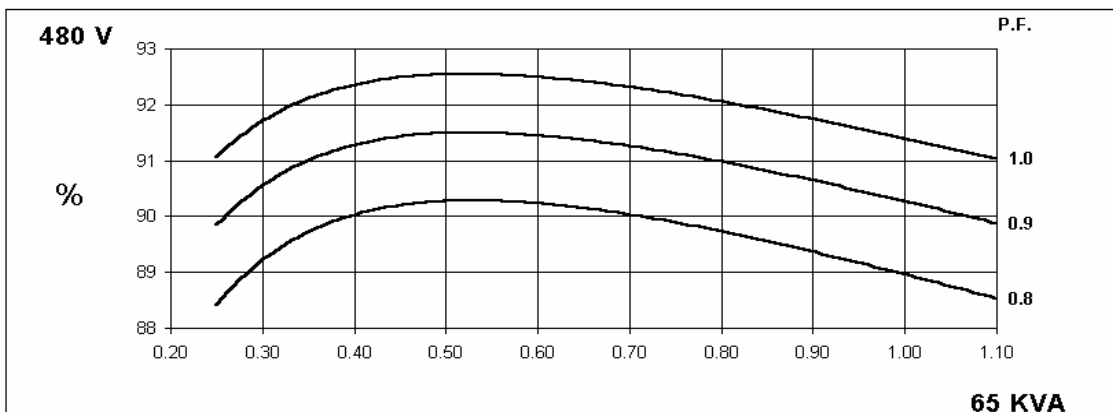
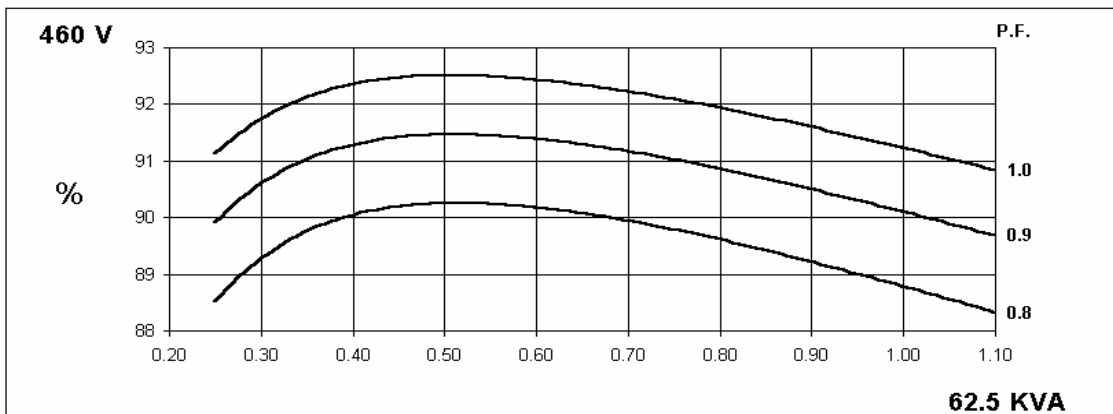
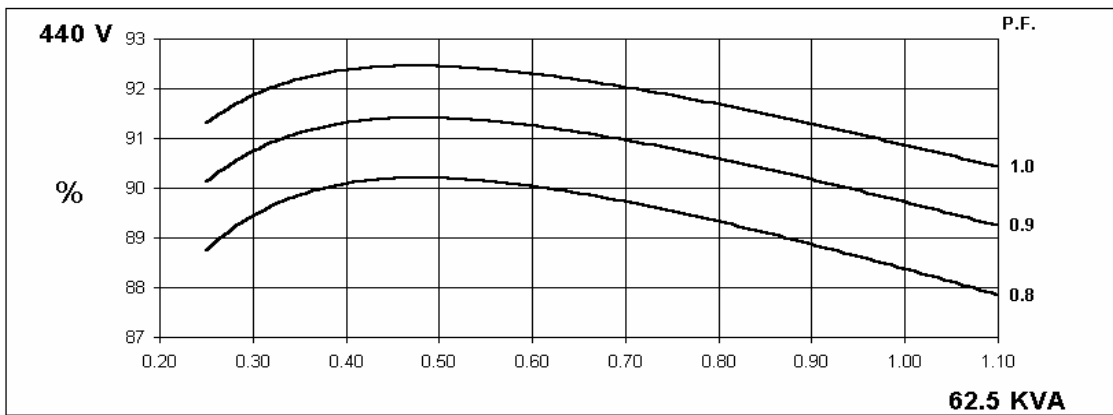
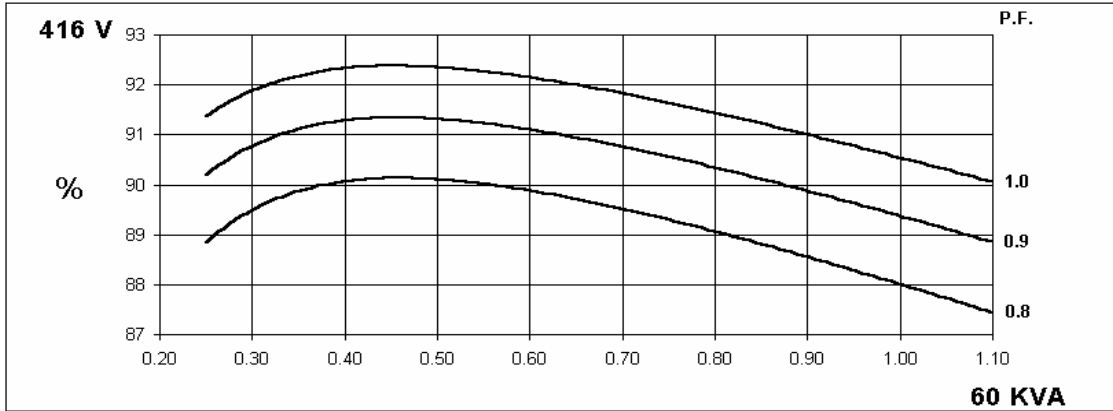

UCI224D
Winding 311

STAMFORD

Locked Rotor Motor Starting Curve

50
Hz

MX

SX

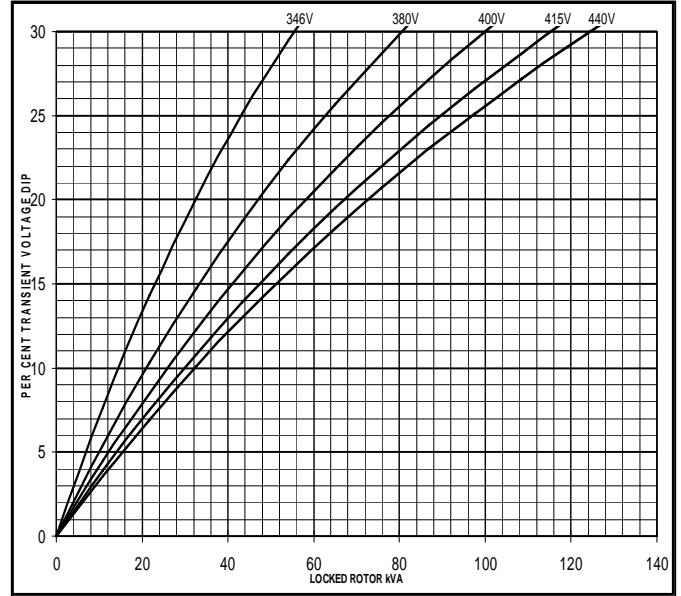
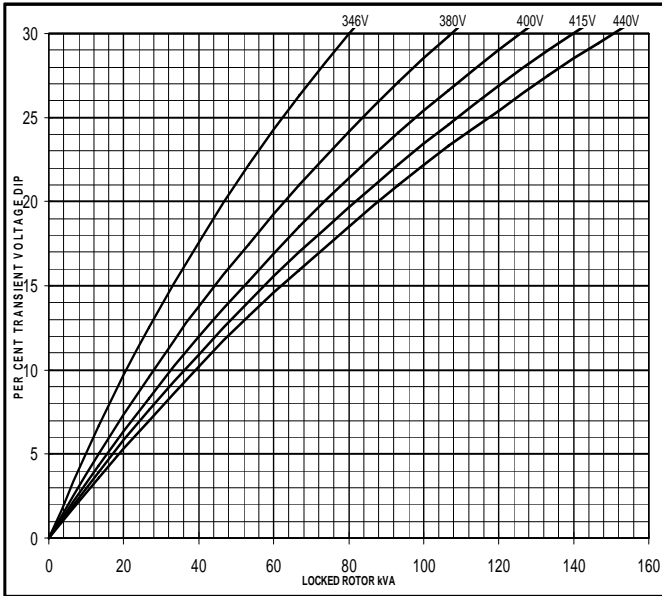

60
Hz

MX

SX

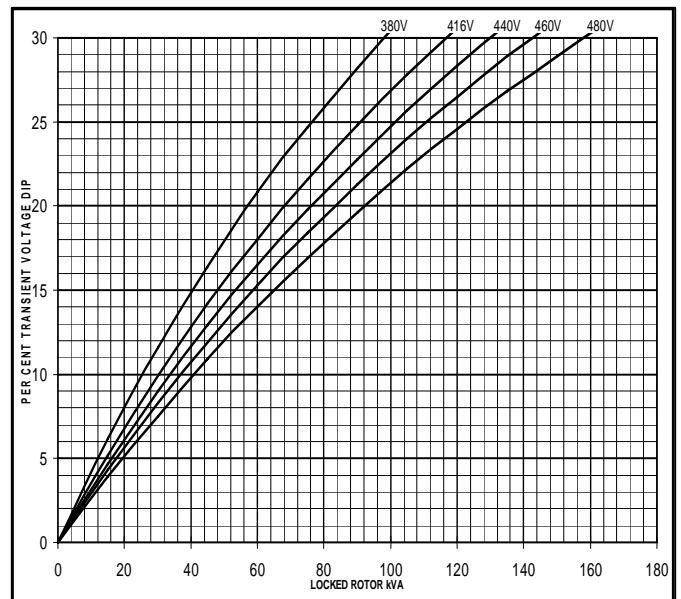
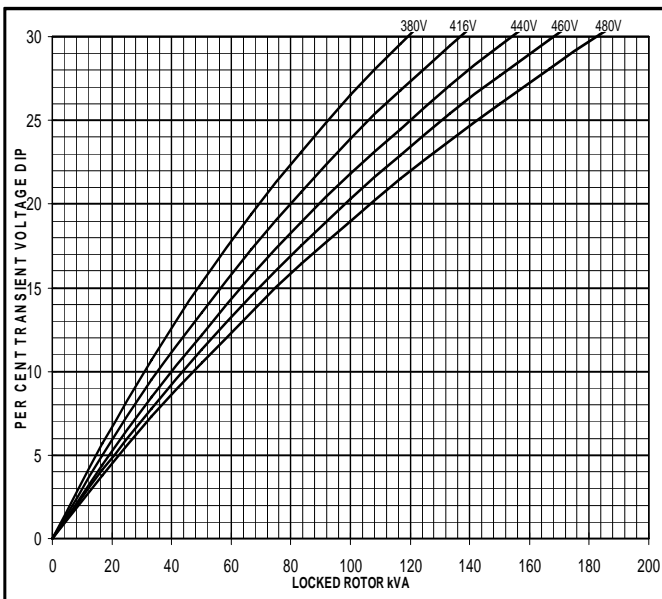

**Three-phase Short Circuit Decrement Curve. No-load Excitation at Rated Speed
Based on star (wye) connection.**

50
Hz

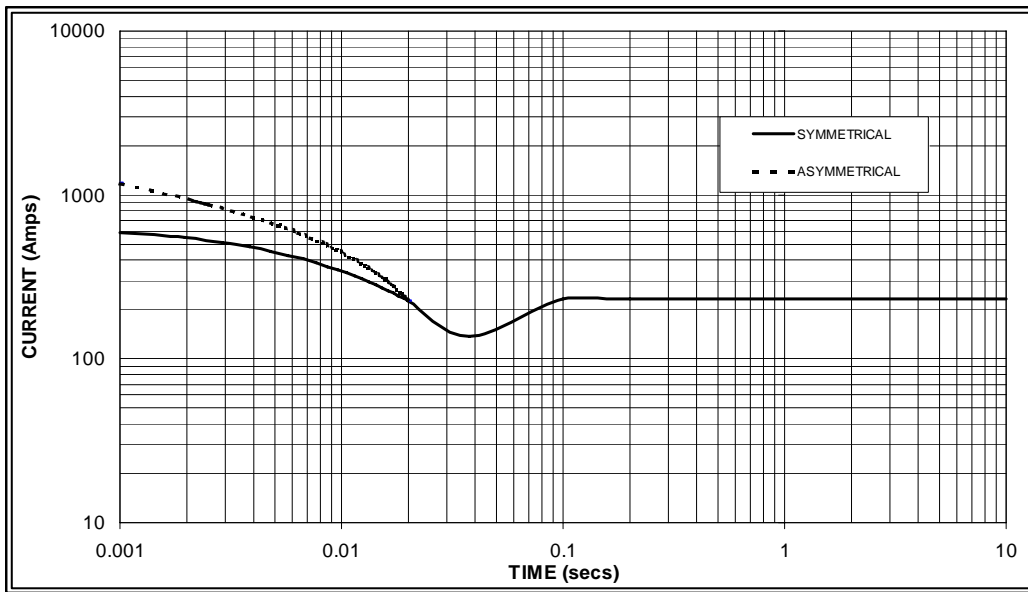

Sustained Short Circuit = 230 Amps

60
Hz

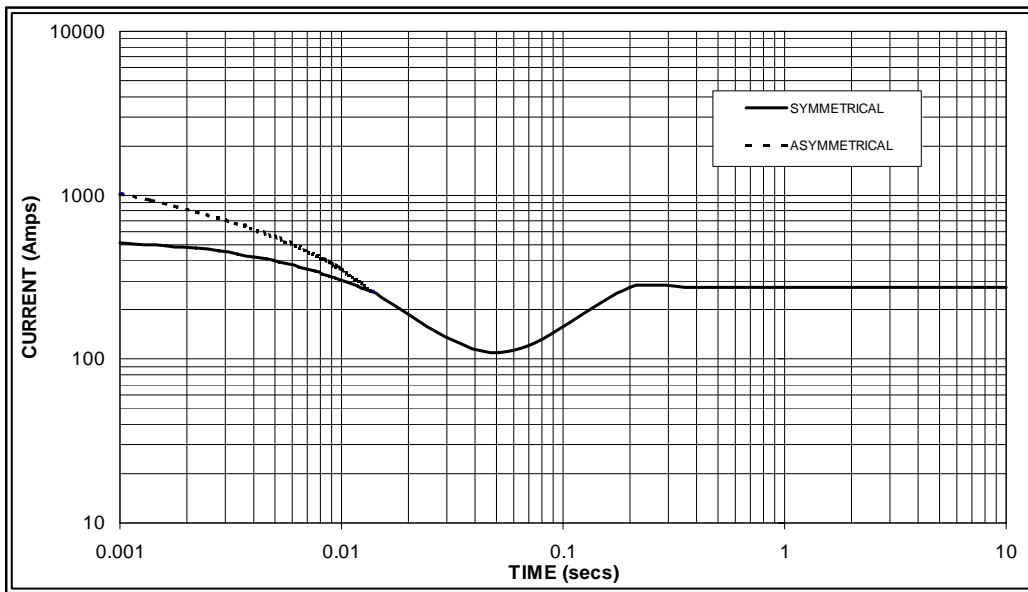

Sustained Short Circuit = 275 Amps

Note 1

The following multiplication factors should be used to adjust the values from curve between time 0.001 seconds and the minimum current point in respect of nominal operating voltage :

50Hz		60Hz	
Voltage	Factor	Voltage	Factor
380v	X 1.00	416v	X 1.00
400v	X 1.07	440v	X 1.06
415v	X 1.12	460v	X 1.12
440v	X 1.18	480v	X 1.17

The sustained current value is constant irrespective of voltage level

Note 2

The following multiplication factor should be used to convert the values calculated in accordance with NOTE 1 to those applicable to the various types of short circuit :

	3-phase	2-phase L-L	1-phase L-N
Instantaneous	x 1.00	x 0.87	x 1.30
Minimum	x 1.00	x 1.80	x 3.20
Sustained	x 1.00	x 1.50	x 2.50
Max. sustained duration	10 sec.	5 sec.	2 sec.

All other times are unchanged

Note 3

Curves are drawn for Star (Wye) connected machines. For other connection the following multipliers should be applied to current values as shown :

Parallel Star = Curve current value X 2

Series Delta = Curve current value X 1.732

UCI224D

STAMFORD

Winding 311 / 0.8 Power Factor

RATINGS

Class - Temp Rise	Cont. F - 105/40°C				Cont. H - 125/40°C				Standby - 150/40°C				Standby - 163/27°C				
50 Hz	Series Star (V)	380	400	415	440	380	400	415	440	380	400	415	440	380	400	415	440
	Parallel Star (V)	190	200	208	220	190	200	208	220	190	200	208	220	190	200	208	220
	Series Delta (V)	220	230	240	254	220	230	240	254	220	230	240	254	220	230	240	254
kVA	45.0	45.0	45.0	33.6	50.0	50.0	50.0	37.5	53.0	53.0	53.0	39.1	55.0	55.0	55.0	41.2	
kW	36.0	36.0	36.0	26.9	40.0	40.0	40.0	30.0	42.4	42.4	42.4	31.3	44.0	44.0	44.0	33.0	
Efficiency (%)	88.3	88.6	88.9	89.3	87.7	88.2	88.5	89.0	87.4	87.9	88.2	88.8	87.2	87.7	88.0	88.6	
kW Input	40.8	40.6	40.5	38.5	45.6	45.4	45.2	43.1	48.5	48.2	48.1	45.0	50.5	50.2	50.0	47.6	

60 Hz	Series Star (V)	416	440	460	480	416	440	460	480	416	440	460	480	416	440	460	480
	Parallel Star (V)	208	220	230	240	208	220	230	240	208	220	230	240	208	220	230	240
	Delta (V)	240	254	266	277	240	254	266	277	240	254	266	277	240	254	266	277
kVA	52.5	55.0	56.0	58.0	60.0	62.5	62.5	65.0	62.5	65.0	65.0	68.8	65.0	66.3	66.3	71.3	
kW	42.0	44.0	44.8	46.4	48.0	50.0	50.0	52.0	50.0	52.0	52.0	55.0	52.0	53.0	53.0	57.0	
Efficiency (%)	88.7	89.0	89.2	89.4	88.0	88.4	88.8	89.0	87.8	88.2	88.6	88.7	87.5	88.1	88.5	88.5	
kW Input	47.4	49.4	50.2	51.9	54.5	56.6	56.3	58.4	56.9	59.0	58.7	62.1	59.4	60.2	59.9	64.5	

DIMENSIONS

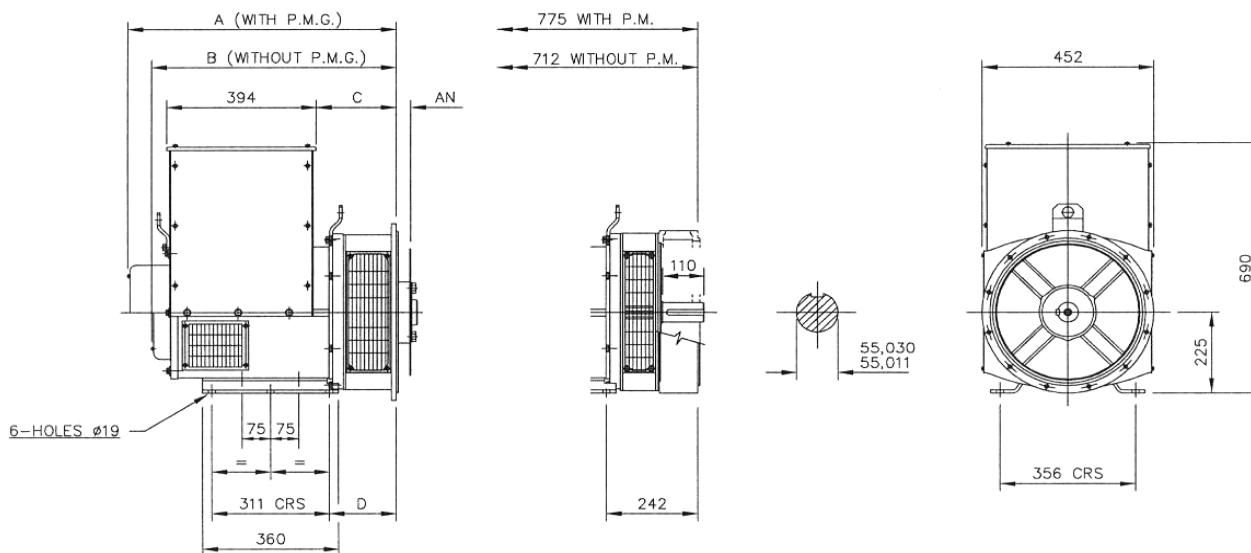

SINGLE BEARING MACHINES ONLY						
ADAPTOR	A	B	C	D	COUPLING DISCS	AN
SAE 1	724,3	661,3	224,3	191,3	SAE 8	61,90
SAE 2	710	647	210	177	SAE 10	53,98
SAE 3	710	647	210	177	SAE 11,5	39,68
SAE 4	710	647	210	177	SAE 14	25,40

STAMFORD

Barnack Road • Stamford • Lincolnshire • PE9 2NB

Tel: 00 44 (0)1780 484000 • Fax: 00 44 (0)1780 484100

S3.8 G7 CoolPac



> Specification sheet

Our energy working for you.™



Description

The Cummins 'S Series' engine powered CoolPac sets offer the lowest cost of maintenance thereby proving to be the most economical power solution. With the robust design and integrated technologies, the 'S Series' CoolPac can command an unrivalled reputation for reliability and performance.

The Cummins 'S Series' engine powered CoolPac sets give you the advantage of optimising your valuable space. All elements of the CoolPac sets are designed from the start to work together to maximize efficiency, even at part loads, thus offering you the advantage of lowest operating costs.

The rugged and reliable Cummins 'S Series' CoolPac sets are unique, because all the major components – the engine and cooling system are manufactured by Cummins India. This integral approach means each element of a CoolPac set is designed to work in harmony from the start.



This engine has been built to comply with CE certification.



This engine has been designed in facilities certified to ISO9001 and manufactured in facilities certified to ISO9001 or ISO9002.

Features

Engine : Cummins 'S Series' CoolPac, powered by Cummins 'S Series' engines, are rated at 1500 RPM and conform to ISO 8528 specifications. The engines are radiator cooled, four stroke and multi-cylinder, conforming to BS 5514/ISO 3046.

The scope of Supply includes :

- Battery Charging Alternator
- Bosch In-line fuel system with mechanical governor
- Dual spin-on fuel filters
- Lube oil filter
- Turbocharger
- Charge Air Cooler (CAC)
- Dry type Air Cleaner
- Coolant recovery bottle
- Fuel pump shut-off coil with Temperature, Pressure & Magnetic Speed sensors
- Flywheel and flywheel housing
- CE compliant guarding
- Oil drain valve

Integrated Design - CoolPac products are supplied fitted with cooling package and medium duty air cleaner for a complete power package. Each component has been specifically developed and rigorously tested for G-Drive products, ensuring high performance, durability and reliability.

Service and Support - G-Drive products are backed by an uncompromising level of technical support and after sales service, delivered through a world class service network.

1500 rpm (50 Hz Ratings)

Gross Engine Output			Net Engine Output			Typical Generator Set Output					
Standby	Prime	Base	Standby	Prime	Base	Standby (ESP)		Prime (PRP)		Base (COP)	
kWm/BHP			kWm/BHP			kWe	kVA	kWe	kVA	kWe	kVA
64.9/87	59.6/79.9	41.7/55.9	62.9/84.2	57.6/77.1	39.7/53.1	52.8	66	48	60	33.6	42



General Engine Data

Type	In line, Radiator cooled
Bore mm	97
Stroke mm	128
Displacement Litre	3.8
Cylinder Block	Cast Iron, 4 Cylinder
Battery Charging Alternator	12V, 35 Amps
Starting Voltage	12V
Fuel System	Direct Injection
Fuel Filter	Spin on
Lube Oil Filter Type(s)	Spin on
Lube Oil Capacity (l)	11
Flywheel Dimensions	SAE3/10

CoolPac Performance Data

Cooling System Design	Charge Air & Jacket Water Cooled
Coolant Ratio	50:50
Coolant Capacity (l)	11
Limiting Ambient Temp. (degC)**	50
Fan Power (Kw)	2
Cooling System Air Flow (m ³ /s)**	0.99
Air Cleaner Type	Dry Type, Replaceable, medium duty

** @ ¼" H₂O

Weight & Dimensions

Length	Width	Height	Weight (dry)
mm	mm	mm	kg
1290	910	1080	500

Fuel Consumption 1500 (50 Hz)

%	kWm	BHP	L/ph	US gal/ph
Standby Power				
100	64.9	87	16.1	4.3
Prime Power				
100	59.6	79.9	14.7	3.9
75	44.7	59.9	11.0	2.9
50	29.8	40	6.1	1.6
25	14.9	20	4.5	1.2
Continuous Power				
100	41.7	55.9	10.6	2.8

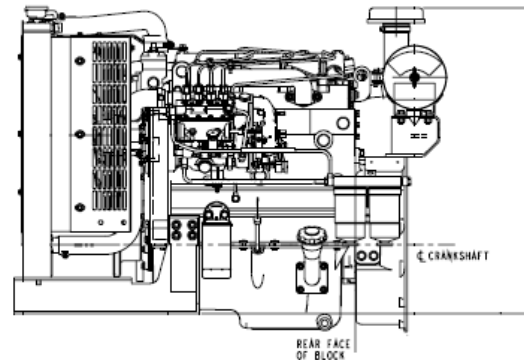

Ratings Definitions

Emergency Standby Power (ESP):

Applicable for supplying power to varying electrical load for the duration of power interruption of a reliable utility source. Emergency Standby Power (ESP) is in accordance with ISO 3046, AS 2789, DIN 6271 and BS 5514.

Limited-Time Running Power (LTP):

Applicable for supplying power to a constant electrical load for limited hours. Limited-Time Running Power (LTP) is in accordance with ISO 8528.

Prime Power (PRP):

Applicable for supplying power to varying electrical load for unlimited hours. Prime Power (PRP) is in accordance with ISO 8528. Ten percent overload capability is available in accordance with ISO 3046, AS 2789, DIN 6271 and BS 5514.

Base Load (Continuous) Power (COP):

Applicable for supplying power continuously to a constant electrical load for unlimited hours. Continuous Power (COP) in accordance with ISO 8528, ISO 3046, AS 2789, DIN6271 and BS 5514.

Cummins G-Drive Engines

Asia Pacific
10 Toh Guan Road
#07-01
TT International Tradepark
Singapore 608838
Phone 65 6417 2388
Fax 65 6417 2399

Europe, CIS, Middle East and Africa
Manston Park Columbus Ave
Manston Ramsgate
Kent CT12 5BF, UK
Phone 44 1843 255000
Fax 44 1843 255902

Latin America
Rua Jati, 310, Cumbica
Guarulhos, SP 07180-900
Brazil
Phone 55 11 2186 4552
Fax 55 11 2186 4729

Mexico
Cummins S. de R.L. de C.V.
Eje 122 No. 200 Zona Industrial
San Luis Potosi, S.L.P. 78090
Mexico
Phone 52 444 870 6700
Fax 52 444 870 6811

North America
1400 73rd Avenue N.E.
Minneapolis, MN 55432
USA
Phone 1 763 574 5000
USA Toll-free 1 877 769 7669
Fax 1 763 574 5298



UCI224E - Technical Data Sheet

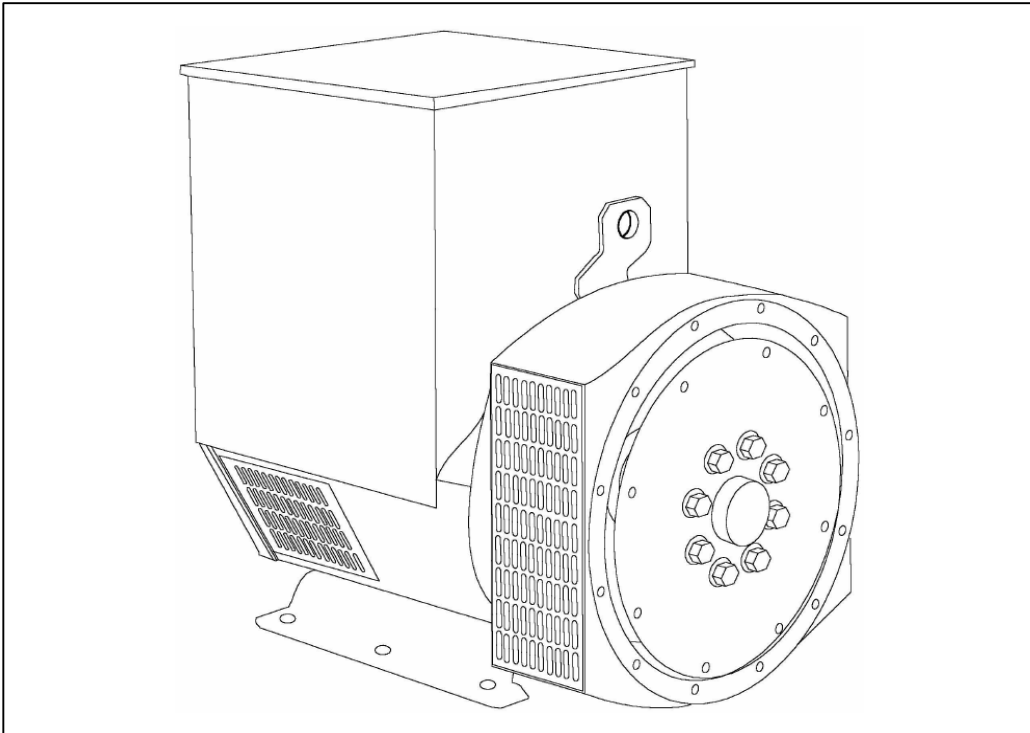

UCI224E

SPECIFICATIONS & OPTIONS



STANDARDS

Newage Stamford industrial generators meet the requirements of BS EN 60034 and the relevant section of other international standards such as BS5000, VDE 0530, NEMA MG1-32, IEC34, CSA C22.2-100, AS1359. Other standards and certifications can be considered on request.

VOLTAGE REGULATORS

SX460 AVR - STANDARD

With this self excited control system the main stator supplies power via the Automatic Voltage Regulator (AVR) to the exciter stator. The high efficiency semiconductors of the AVR ensure positive build-up from initial low levels of residual voltage.

The exciter rotor output is fed to the main rotor through a three phase full wave bridge rectifier. This rectifier is protected by a surge suppressor against surges caused, for example, by short circuit.

SX440 AVR

With this self-excited system the main stator provides power via the AVR to the exciter stator. The high efficiency semi-conductors of the AVR ensure positive build-up from initial low levels of residual voltage.

The exciter rotor output is fed to the main rotor through a three-phase full-wave bridge rectifier. The rectifier is protected by a surge suppressor against surges caused, for example, by short circuit or out-of-phase paralleling.

The SX440 will support a range of electronic accessories, including a 'droop' Current Transformer (CT) to permit parallel operation with other ac generators.

If 3-phase sensing is required with the self-excited system, the SX421 AVR must be used.

SX421AVR

This AVR also operates in a self-excited system. It combines all the features of the SX440 with, additionally, three-phase rms sensing for improved regulation and performance. Over voltage protection is provided via a separate circuit breaker. An engine relief load acceptance feature is built in as standard.

MX341 AVR

This sophisticated AVR is incorporated into the Stamford Permanent Magnet Generator (PMG) control system.

The PMG provides power via the AVR to the main exciter, giving a source of constant excitation power independent of generator output. The main exciter output is then fed to the main rotor, through a full wave bridge, protected by a surge suppressor. The AVR has in-built protection against sustained over-excitation, caused by internal or external faults. This de-excites the machine after a minimum of 5 seconds.

An engine relief load acceptance feature can enable full load to be applied to the generator in a single step.

If three-phase sensing is required with the PMG system the MX321 AVR must be used.

We recommend three-phase sensing for applications with greatly unbalanced or highly non-linear loads.

MX321 AVR

The most sophisticated of all our AVRs combines all the features of the MX341 with, additionally, three-phase rms sensing, for improved regulation and performance. Over voltage protection is built-in and short circuit current level adjustments is an optional facility.

WINDINGS & ELECTRICAL PERFORMANCE

All generator stators are wound to 2/3 pitch. This eliminates triplen (3rd, 9th, 15th ...) harmonics on the voltage waveform and is found to be the optimum design for trouble-free supply of non-linear loads. The 2/3 pitch design avoids excessive neutral currents sometimes seen with higher winding pitches, when in parallel with the mains. A fully connected damper winding reduces oscillations during paralleling. This winding, with the 2/3 pitch and carefully selected pole and tooth designs, ensures very low waveform distortion.

TERMINALS & TERMINAL BOX

Standard generators are 3-phase reconnectable with 12 ends brought out to the terminals, which are mounted on a cover at the non-drive end of the generator. A sheet steel terminal box contains the AVR and provides ample space for the customers' wiring and gland arrangements. It has removable panels for easy access.

SHAFT & KEYS

All generator rotors are dynamically balanced to better than BS6861:Part 1 Grade 2.5 for minimum vibration in operation. Two bearing generators are balanced with a half key.

INSULATION/IMPREGNATION

The insulation system is class 'H'.

All wound components are impregnated with materials and processes designed specifically to provide the high build required for static windings and the high mechanical strength required for rotating components.

QUALITY ASSURANCE

Generators are manufactured using production procedures having a quality assurance level to BS EN ISO 9001.

The stated voltage regulation may not be maintained in the presence of certain radio transmitted signals. Any change in performance will fall within the limits of Criteria 'B' of EN 61000-6-2:2001. At no time will the steady-state voltage regulation exceed 2%.

NB Continuous development of our products entitles us to change specification details without notice, therefore they must not be regarded as binding.

Front cover drawing typical of product range.

UCI224E
WINDING 311

CONTROL SYSTEM	SEPARATELY EXCITED BY P.M.G.							
A.V.R.	MX321	MX341						
VOLTAGE REGULATION	± 0.5 %	± 1.0 %	With 4% ENGINE GOVERNING					
SUSTAINED SHORT CIRCUIT	REFER TO SHORT CIRCUIT DECREMENT CURVES (page 7)							
CONTROL SYSTEM	SELF EXCITED							
A.V.R.	SX460	SX440	SX421					
VOLTAGE REGULATION	± 1.5 %	± 1.0 %	± 0.5 %	With 4% ENGINE GOVERNING				
SUSTAINED SHORT CIRCUIT	SERIES 4 CONTROL DOES NOT SUSTAIN A SHORT CIRCUIT CURRENT							
INSULATION SYSTEM	CLASS H							
PROTECTION	IP23							
RATED POWER FACTOR	0.8							
STATOR WINDING	DOUBLE LAYER CONCENTRIC							
WINDING PITCH	TWO THIRDS							
WINDING LEADS	12							
STATOR WDG. RESISTANCE	0.101 Ohms PER PHASE AT 22°C SERIES STAR CONNECTED							
ROTOR WDG. RESISTANCE	0.69 Ohms at 22°C							
EXCITER STATOR RESISTANCE	20 Ohms at 22°C							
EXCITER ROTOR RESISTANCE	0.078 Ohms PER PHASE AT 22°C							
R.F.I. SUPPRESSION	BS EN 61000-6-2 & BS EN 61000-6-4, VDE 0875G, VDE 0875N. refer to factory for others							
WAVEFORM DISTORTION	NO LOAD < 1.5% NON-DISTORTING BALANCED LINEAR LOAD < 5.0%							
MAXIMUM OVERSPEED	2250 Rev/Min							
BEARING DRIVE END	BALL. 6312-2RS (ISO)							
BEARING NON-DRIVE END	BALL. 6309-2RS (ISO)							
	1 BEARING				2 BEARING			
WEIGHT COMP. GENERATOR	311 kg				330 kg			
WEIGHT WOUND STATOR	103 kg				103 kg			
WEIGHT WOUND ROTOR	95.89 kg				87.52 kg			
WR ² INERTIA	0.4999 kgm ²				0.4682 kgm ²			
SHIPPING WEIGHTS in a crate	334 kg				351 kg			
PACKING CRATE SIZE	105 x 57 x 96(cm)				105 x 57 x 96(cm)			
	50 Hz				60 Hz			
TELEPHONE INTERFERENCE	THF<2%				TIF<50			
COOLING AIR	0.216 m ³ /sec 458 cfm				0.281 m ³ /sec 595 cfm			
VOLTAGE SERIES STAR	380/220	400/231	415/240	440/254	416/240	440/254	460/266	480/277
VOLTAGE PARALLEL STAR	190/110	200/115	208/120	220/127	208/120	220/127	230/133	240/138
VOLTAGE SERIES DELTA	220/110	230/115	240/120	254/127	240/120	254/127	266/133	277/138
KVA BASE RATING FOR REACTANCE VALUES	60	60	60	58	67.5	70	72.5	75
X _d DIR. AXIS SYNCHRONOUS	2.48	2.24	2.08	1.79	3.00	2.78	2.64	2.50
X' _d DIR. AXIS TRANSIENT	0.19	0.17	0.16	0.14	0.22	0.20	0.19	0.18
X'' _d DIR. AXIS SUBTRANSIENT	0.13	0.12	0.11	0.09	0.15	0.14	0.13	0.13
X _q QUAD. AXIS REACTANCE	1.13	1.02	0.95	0.82	1.38	1.28	1.21	1.15
X'' _q QUAD. AXIS SUBTRANSIENT	0.14	0.13	0.12	0.10	0.14	0.13	0.12	0.12
X _L LEAKAGE REACTANCE	0.08	0.08	0.07	0.06	0.09	0.08	0.08	0.08
X ₂ NEGATIVE SEQUENCE	0.13	0.12	0.11	0.09	0.14	0.13	0.12	0.12
X ₀ ZERO SEQUENCE	0.11	0.10	0.09	0.08	0.09	0.08	0.08	0.08
REACTANCES ARE SATURATED				VALUES ARE PER UNIT AT RATING AND VOLTAGE INDICATED				
T' _d TRANSIENT TIME CONST.	0.028 s							
T'' _d SUB-TRANSTIME CONST.	0.007 s							
T' _{do} O.C. FIELD TIME CONST.	0.7 s							
T _a ARMATURE TIME CONST.	0.006 s							
SHORT CIRCUIT RATIO	1/X _d							

**50
Hz**

UCI224E
Winding 311



THREE PHASE EFFICIENCY CURVES

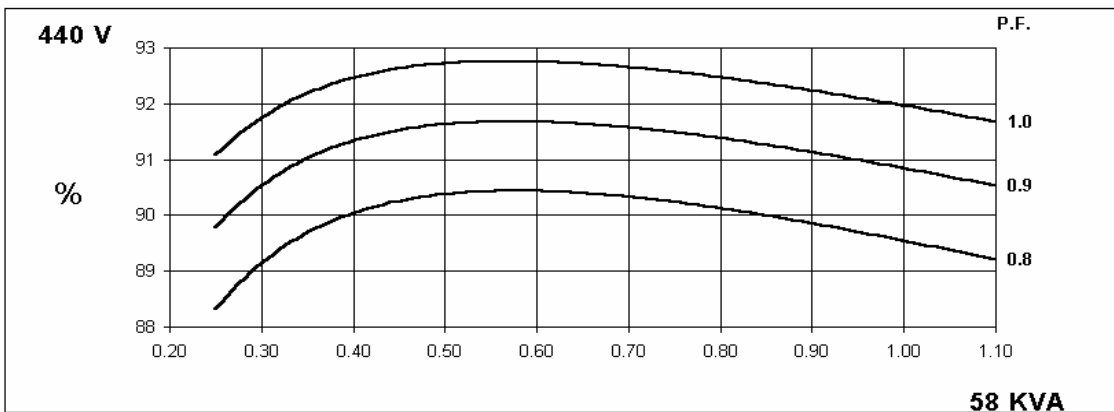
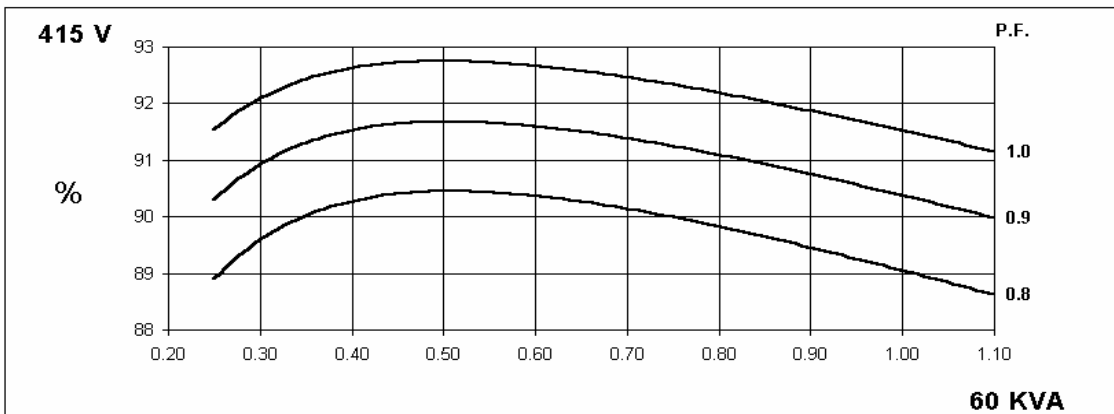
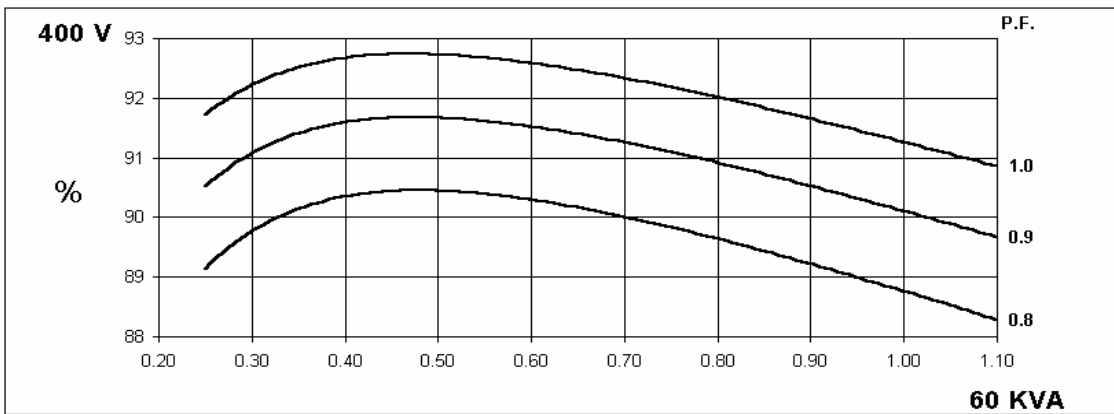
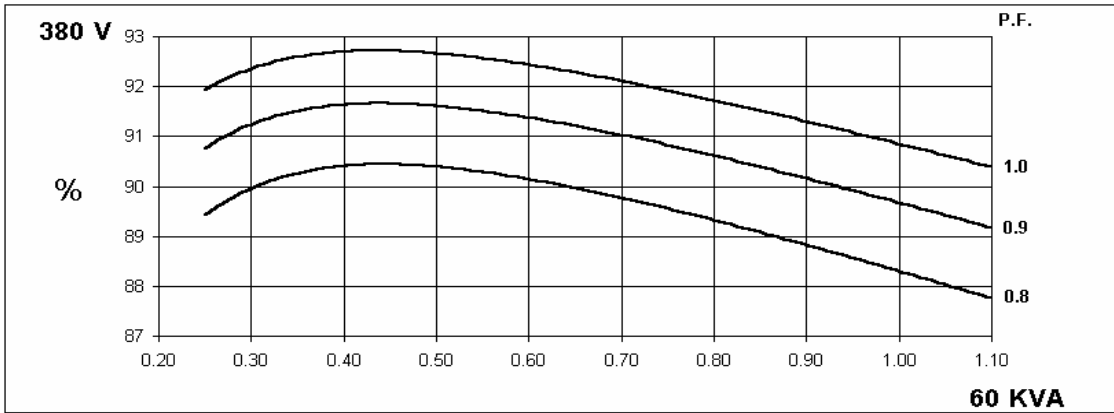

THREE PHASE EFFICIENCY CURVES

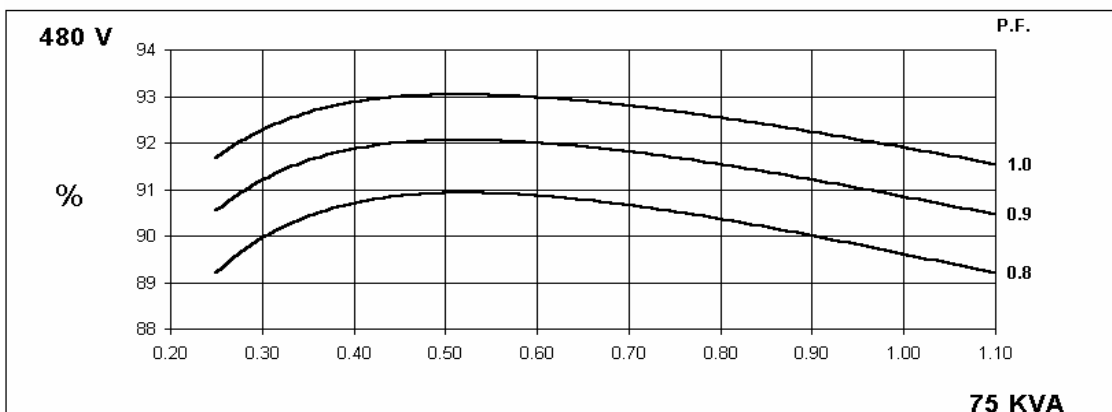
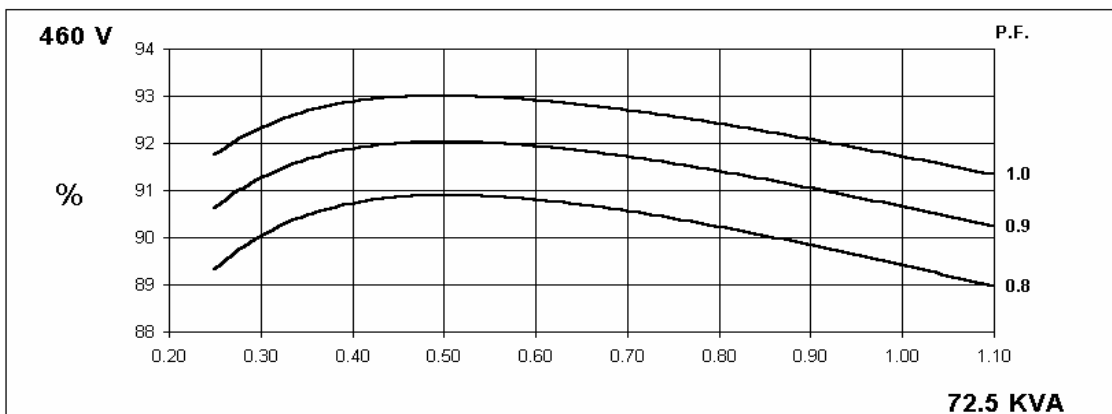
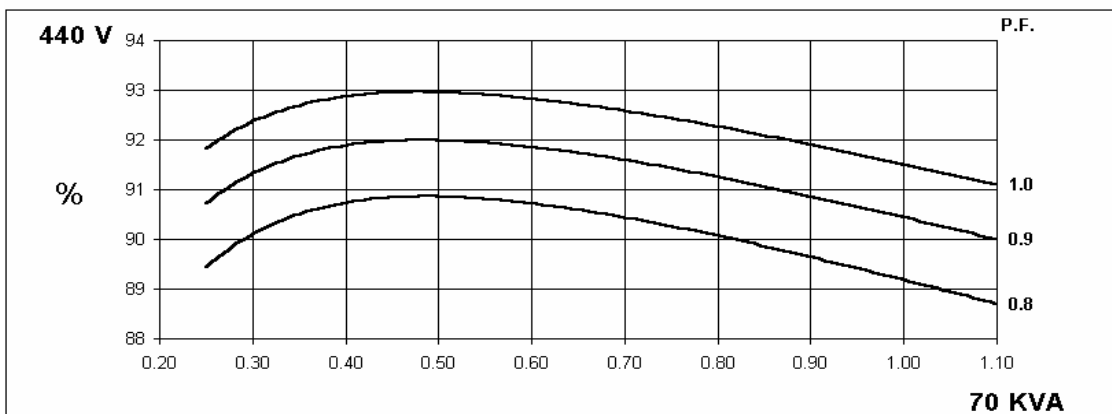
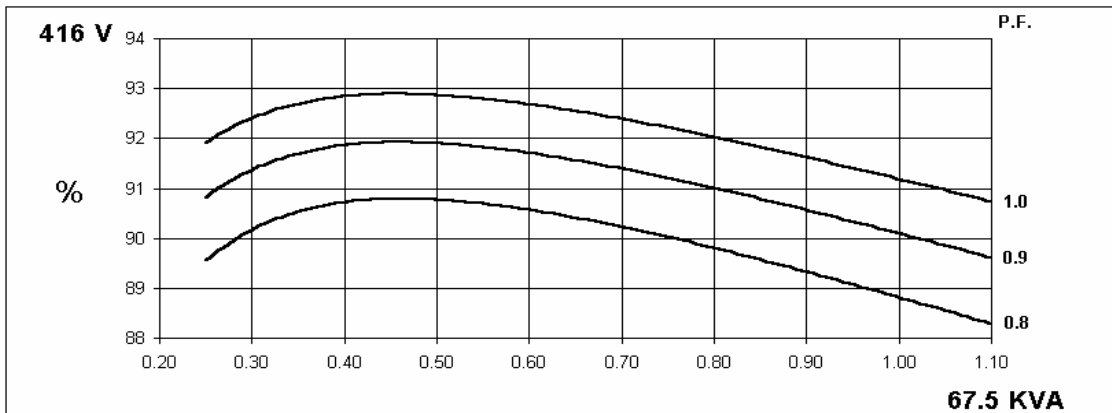

UCI224E

Winding 311



Locked Rotor Motor Starting Curve

**50
Hz**

MX

SX

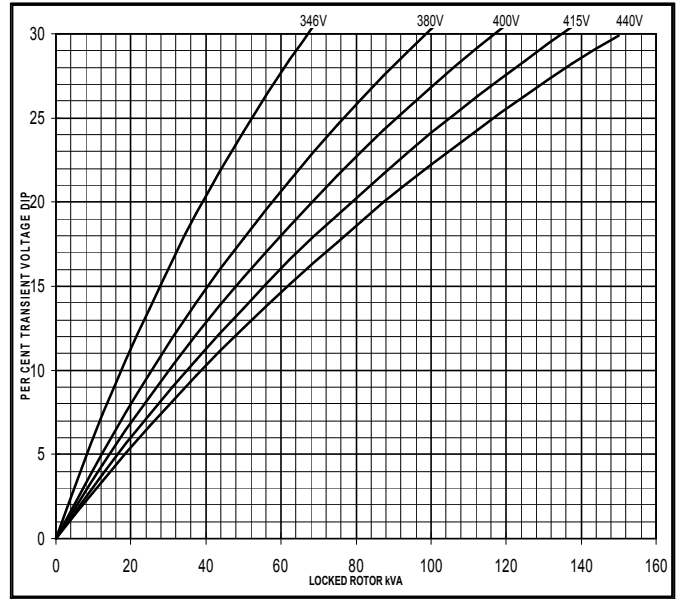
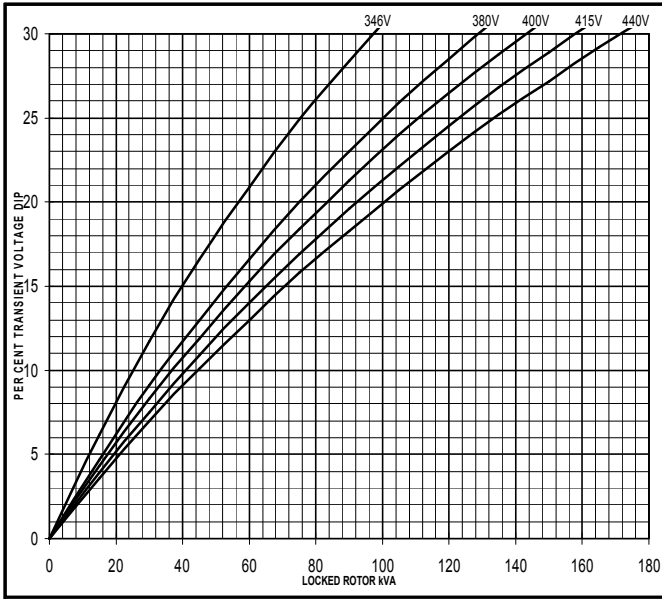

**60
Hz**

MX

SX

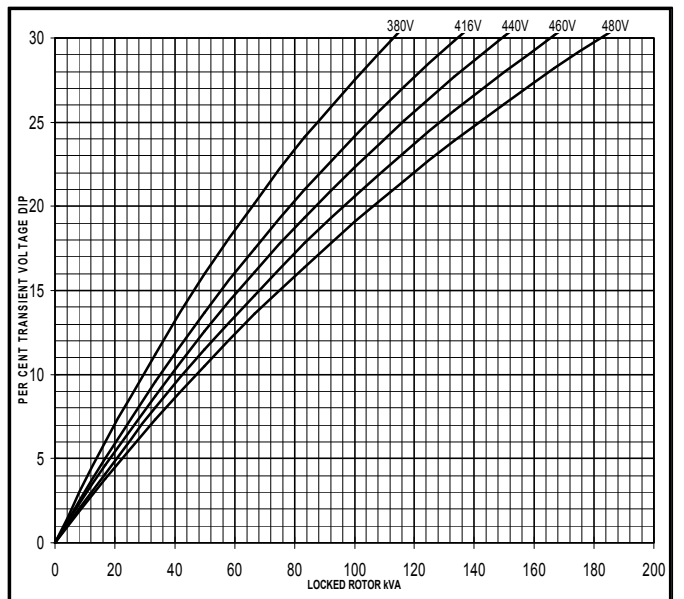
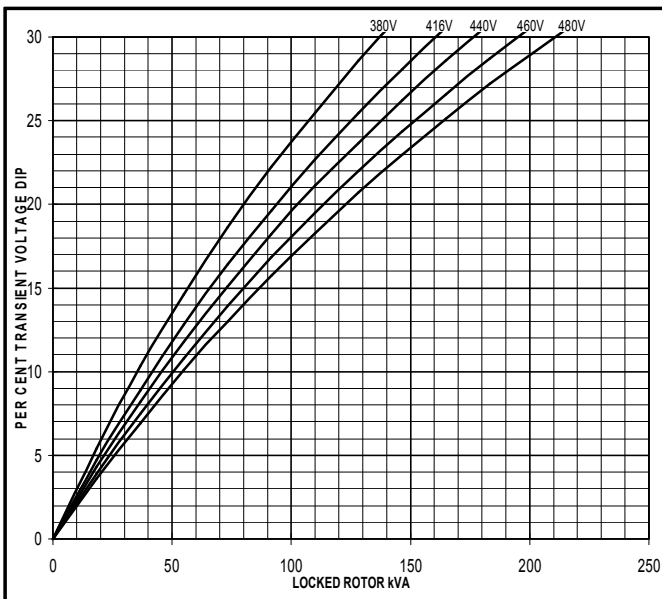

**Three-phase Short Circuit Decrement Curve. No-load Excitation at Rated Speed
Based on star (wye) connection.**

**50
Hz**

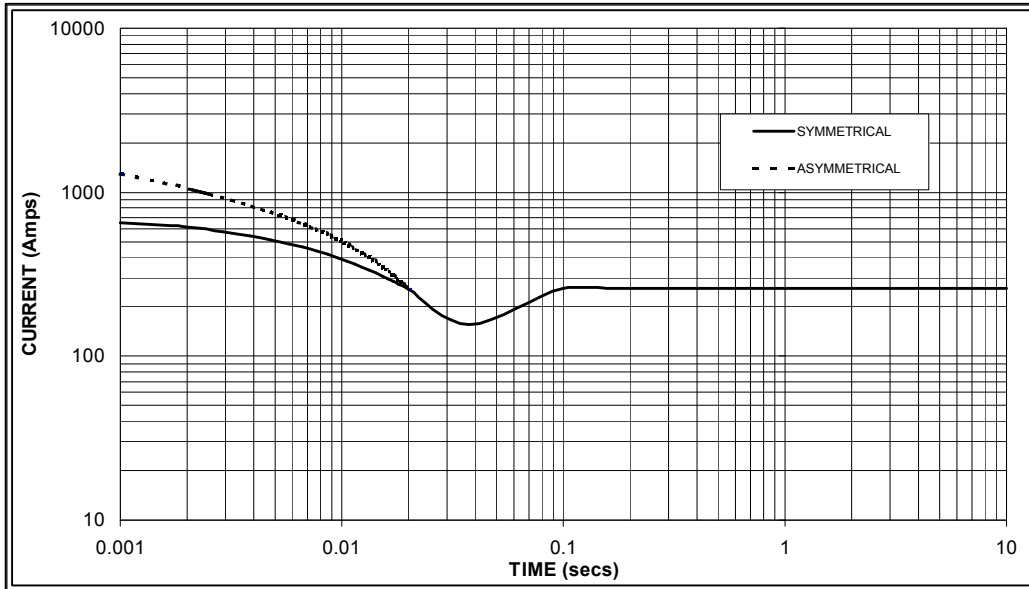

Sustained Short Circuit = 260 Amps

**60
Hz**

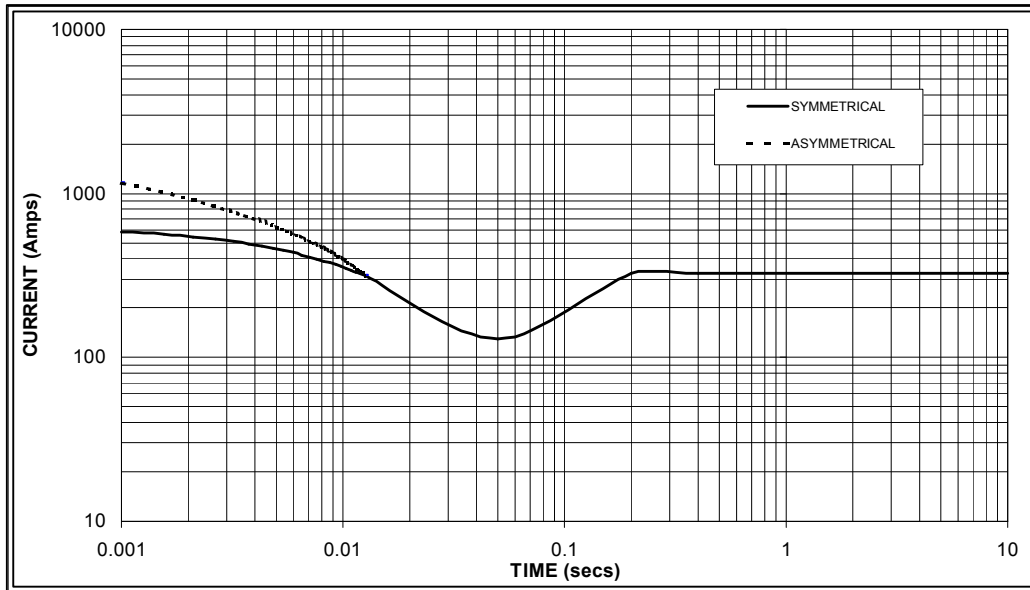

Sustained Short Circuit = 325 Amps

Note 1

The following multiplication factors should be used to adjust the values from curve between time 0.001 seconds and the minimum current point in respect of nominal operating voltage :

50Hz		60Hz	
Voltage	Factor	Voltage	Factor
380v	X 1.00	416v	X 1.00
400v	X 1.07	440v	X 1.06
415v	X 1.12	460v	X 1.12
440v	X 1.18	480v	X 1.17

The sustained current value is constant irrespective of voltage level

Note 2

The following multiplication factor should be used to convert the values calculated in accordance with NOTE 1 to those applicable to the various types of short circuit :

	3-phase	2-phase L-L	1-phase L-N
Instantaneous	x 1.00	x 0.87	x 1.30
Minimum	x 1.00	x 1.80	x 3.20
Sustained	x 1.00	x 1.50	x 2.50
Max. sustained duration	10 sec.	5 sec.	2 sec.

All other times are unchanged

Note 3

Curves are drawn for Star (Wye) connected machines. For other connection the following multipliers should be applied to current values as shown :

Parallel Star = Curve current value X 2

Series Delta = Curve current value X 1.732

UCI224E

Winding 311 / 0.8 Power Factor



RATINGS

Class - Temp Rise	Cont. F - 105/40°C				Cont. H - 125/40°C				Standby - 150/40°C				Standby - 163/27°C				
50 Hz	Series Star (V)	380	400	415	440	380	400	415	440	380	400	415	440	380	400	415	440
	Parallel Star (V)	190	200	208	220	190	200	208	220	190	200	208	220	190	200	208	220
	Series Delta (V)	220	230	240	254	220	230	240	254	220	230	240	254	220	230	240	254
kVA	53.0	53.0	53.0	40.3	60.0	60.0	60.0	45.0	61.0	61.0	61.0	45.8	63.0	63.0	63.0	47.3	
kW	42.4	42.4	42.4	32.2	48.0	48.0	48.0	36.0	48.8	48.8	48.8	36.6	50.4	50.4	50.4	37.8	
Efficiency (%)	88.9	89.3	89.5	89.9	88.3	88.8	89.1	89.5	88.2	88.7	89.0	89.5	88.0	88.5	88.8	89.4	
kW Input	47.7	47.5	47.4	46.3	54.4	54.1	53.9	51.8	55.3	55.0	54.8	52.7	57.3	56.9	56.8	54.6	

60 Hz	Series Star (V)	416	440	460	480	416	440	460	480	416	440	460	480	416	440	460	480
	Parallel Star (V)	208	220	230	240	208	220	230	240	208	220	230	240	208	220	230	240
	Delta (V)	240	254	266	277	240	254	266	277	240	254	266	277	240	254	266	277
kVA	62.5	65.0	65.0	68.0	67.5	70.0	72.5	75.0	70.0	73.8	73.8	78.8	72.5	75.0	75.0	80.0	
kW	50.0	52.0	52.0	54.4	54.0	56.0	58.0	60.0	56.0	59.0	59.0	63.0	58.0	60.0	60.0	64.0	
Efficiency (%)	89.2	89.5	89.9	90.0	88.8	89.2	89.4	89.6	88.6	88.9	89.3	89.4	88.4	88.8	89.3	89.3	
kW Input	56.1	58.1	57.8	60.4	60.8	62.8	64.9	67.0	63.2	66.4	66.1	70.5	65.6	67.6	67.2	71.7	

DIMENSIONS

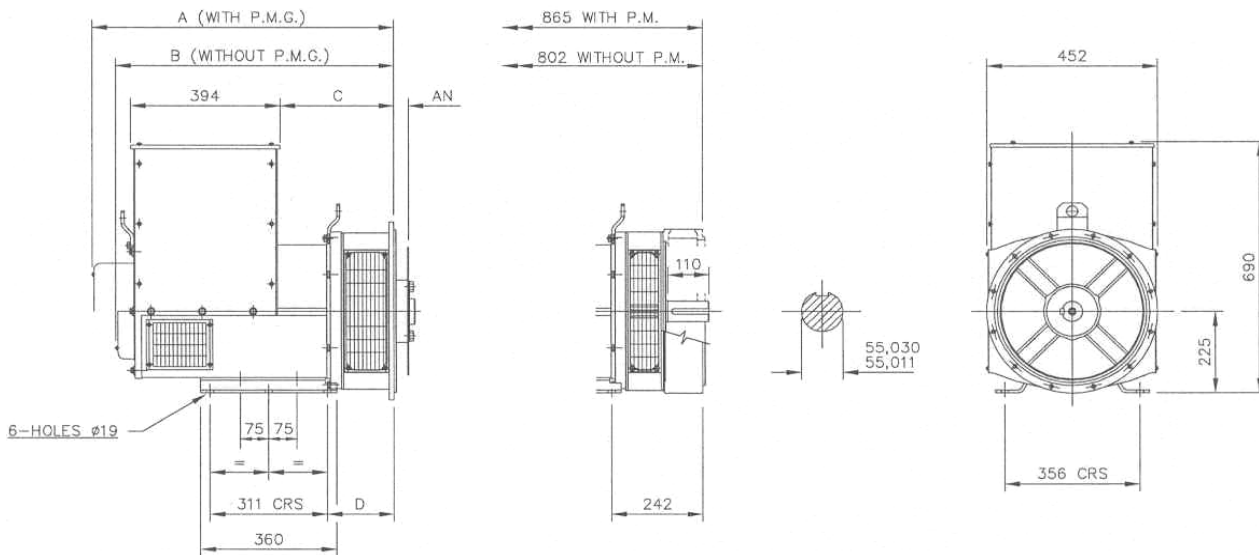

SINGLE BEARING MACHINES ONLY						
ADAPTOR	A	B	C	D	COUPLING DISCS	AN
SAE 1	814,3	751,3	314,3	191,3	SAE 8	61,90
SAE 2	800	737	300	177	SAE 10	53,98
SAE 3	800	737	300	177	SAE 11,5	39,68
SAE 4	800	737	300	177	SAE 14	25,40



Barnack Road • Stamford • Lincolnshire • PE9 2NB

Tel: 00 44 (0)1780 484000 • Fax: 00 44 (0)1780 484100

S3.8 G6 CoolPac

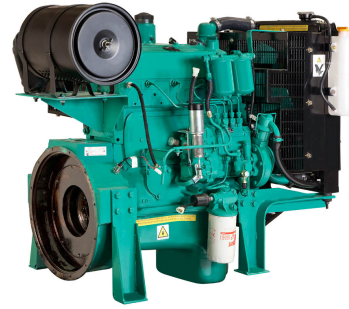

> Specification sheet



Our energy working for you.™

Description

The Cummins 'S Series' engine powered CoolPac sets offer the lowest cost of maintenance thereby proving to be the most economical power solution. With the robust design and integrated technologies, the 'S Series' CoolPac can command an unrivalled reputation for reliability and performance.

The Cummins 'S Series' engine powered CoolPac sets give you the advantage of optimising your valuable space. All elements of the CoolPac sets are designed from the start to work together to maximize efficiency, even at part loads, thus offering you the advantage of lowest operating costs.

The rugged and reliable Cummins 'S Series' CoolPac sets are unique, because all the major components – the engine and cooling system are manufactured by Cummins India. This integral approach means each element of a CoolPac set is designed to work in harmony from the start.

Features

Engine : Cummins[®] 'S Series' CoolPac sets, powered by Cummins[®] 'S Series' engine, are rated at 1500 RPM and conform to ISO 8528 specifications. The engines are radiator cooled, four stroke and multi-cylinder, conforming to BS 5514/ISO 3046.

The scope of Supply includes :

- Battery Charging Alternator
- Bosch In-line fuel system with mechanical governor
- Dual spin-on fuel filter
- Lube oil filter
- Turbocharger
- Dry type Air Cleaner
- Coolant recovery bottle
- Fuel pump shut-off coil with safeties (LLOP, HWT)
- Flywheel and flywheel housing
- CE compliant guarding
- Oil drainage valve



This engine has been built to comply with CE certification.



This engine has been designed in facilities certified to ISO9001 and manufactured in facilities certified to ISO9001 or ISO9002.

Integrated Design - CoolPac products are supplied fitted with cooling package and medium duty air cleaner for a complete power package. Each component has been specifically developed and rigorously tested for G-Drive products, ensuring high performance, durability and reliability.

Service and Support - G-Drive products are backed by an uncompromising level of technical support and after sales service, delivered through a world class service network.

1500 rpm (50 Hz Ratings)

Gross Engine Output			Net Engine Output			Typical Generator Set Output					
Standby	Prime	Base	Standby	Prime	Base	Standby (ESP)		Prime (PRP)		Base (COP)	
kWm/BHP			kWm/BHP			kWe	kVA	kWe	kVA	kWe	kVA
53.6/71.9	48.7/65.3	34.1/45.7	51.6/69.1	46.7/62.6	32.1/43	44	55	40	50	28	35



General Engine Data

Type	In line, Radiator cooled
Bore mm	97
Stroke mm	128
Displacement Litre	3.8
Cylinder Block	Cast Iron, 4 Cylinder
Battery Charging Alternator	12V, 35 Amps
Starting Voltage	12V
Fuel System	Direct Injection
Fuel Filter	Spin on
Lube Oil Filter Type(s)	Spin on
Lube Oil Capacity (l)	11
Flywheel Dimensions	SAE3/10

1782

CoolPac Performance Data

Cooling System Design	Jacket Water Cooled
Coolant Ratio	50:50
Coolant Capacity (l)	11
Limiting Ambient Temp. (degC)**	45
Fan Power (Kw)	2
Cooling System Air Flow (m ³ /s)**	0.99
Air Cleaner Type	Dry Type, Replaceable, medium duty

** @ ¼" H₂O

Weight & Dimensions

Length	Width	Height	Weight (dry)
mm	mm	mm	kg
1135	740	980	450

Fuel Consumption 1500 (50 Hz)

%	kWm	BHP	L/ph	US gal/ph
Standby Power				
100	53.6	71.9	14.3	3.8
Prime Power				
100	48.7	65.3	12.8	3.4
75	36.5	48.9	9.5	2.5
50	24.3	32.6	6.5	1.7
25	12.2	16.4	4.0	1.1
Continuous Power				
100	34.1	45.7	9.1	2.4

Cummins G-Drive Engines

Asia Pacific

10 Toh Guan Road
#07-01
TT International Tradepark
Singapore 608838
Phone 65 6417 2388
Fax 65 6417 2399

Europe, CIS, Middle East and Africa

Manston Park Columbus Ave
Manston Ramsgate
Kent CT12 5BF. UK
Phone 44 1843 255000
Fax 44 1843 255902

Latin America

Rua Jati, 310, Cumbica
Guarulhos, SP 07180-900
Brazil
Phone 55 11 2186 4552
Fax 55 11 2186 4729

Mexico

Cummins S. de R.L. de C.V.
Eje 122 No. 200 Zona Industrial
San Luis Potosi, S.L.P. 78090
Mexico
Phone 52 444 870 6700
Fax 52 444 870 6811

North America

1400 73rd Avenue N.E.
Minneapolis, MN 55432
USA
Phone 1 763 574 5000
USA Toll-free 1 877 769 7669
Fax 1 763 574 5298

Ratings Definitions

Emergency Standby Power (ESP):

Applicable for supplying power to varying electrical load for the duration of power interruption of a reliable utility source. Emergency Standby Power (ESP) is in accordance with ISO 8528. Fuel Stop power in accordance with ISO 3046, AS 2789, DIN 6271 and BS 5514.

Limited-Time Running Power (LTP):

Applicable for supplying power to a constant electrical load for limited hours. Limited-Time Running Power (LTP) is in accordance with ISO 8528.

Prime Power (PRP):

Applicable for supplying power to varying electrical load for unlimited hours. Prime Power (PRP) is in accordance with ISO 8528. Ten percent overload capability is available in accordance with ISO 3046, AS 2789, DIN 6271 and BS 5514.

Base Load (Continuous) Power (COP):

Applicable for supplying power continuously to a constant electrical load for unlimited hours. Continuous Power (COP) in accordance with ISO 8528, ISO 3046, AS 2789, DIN6271 and BS 5514.



STAMFORD®

UCI224D - Technical Data Sheet

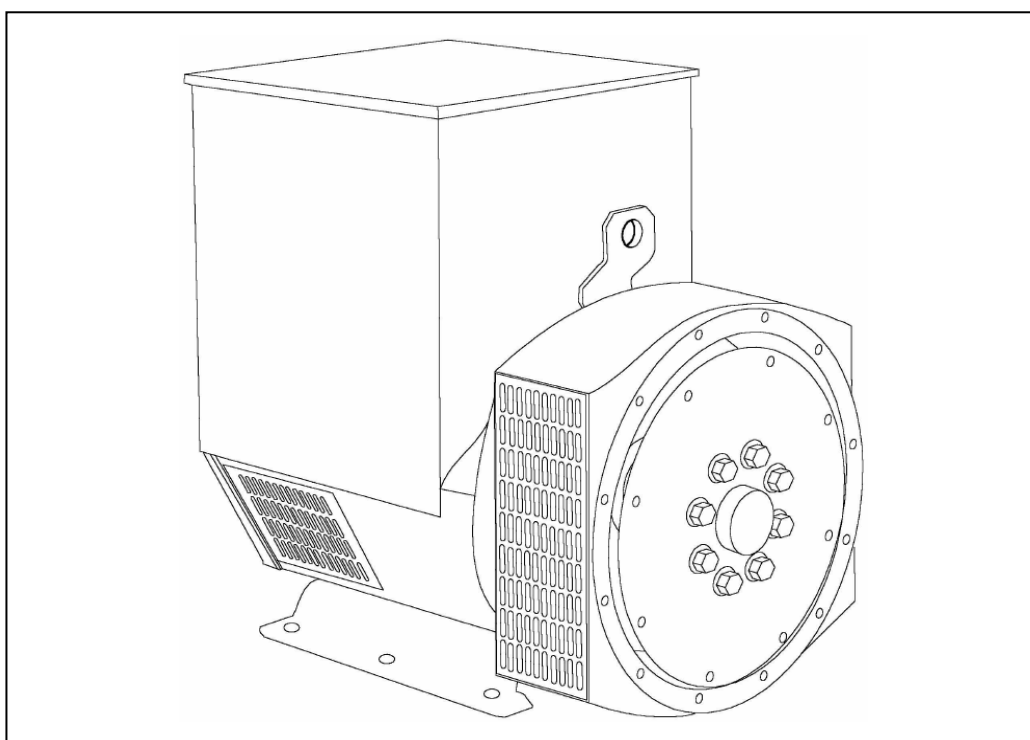

UCI224D

SPECIFICATIONS & OPTIONS

STAMFORD

STANDARDS

Newage Stamford industrial generators meet the requirements of BS EN 60034 and the relevant section of other international standards such as BS5000, VDE 0530, NEMA MG1-32, IEC34, CSA C22.2-100, AS1359. Other standards and certifications can be considered on request.

VOLTAGE REGULATORS

SX460 AVR - STANDARD

With this self excited control system the main stator supplies power via the Automatic Voltage Regulator (AVR) to the exciter stator. The high efficiency semiconductors of the AVR ensure positive build-up from initial low levels of residual voltage.

The exciter rotor output is fed to the main rotor through a three phase full wave bridge rectifier. This rectifier is protected by a surge suppressor against surges caused, for example, by short circuit.

AS440 AVR

With this self-excited system the main stator provides power via the AVR to the exciter stator. The high efficiency semi-conductors of the AVR ensure positive build-up from initial low levels of residual voltage.

The exciter rotor output is fed to the main rotor through a three-phase full-wave bridge rectifier. The rectifier is protected by a surge suppressor against surges caused, for example, by short circuit or out-of-phase paralleling.

The AS440 will support a range of electronic accessories, including a 'droop' Current Transformer (CT) to permit parallel operation with other ac generators.

MX341 AVR

This sophisticated AVR is incorporated into the Stamford Permanent Magnet Generator (PMG) control system.

The PMG provides power via the AVR to the main exciter, giving a source of constant excitation power independent of generator output. The main exciter output is then fed to the main rotor, through a full wave bridge, protected by a surge suppressor. The AVR has in-built protection against sustained over-excitation, caused by internal or external faults. This de-excites the machine after a minimum of 5 seconds.

An engine relief load acceptance feature can enable full load to be applied to the generator in a single step.

If three-phase sensing is required with the PMG system the MX321 AVR must be used.

We recommend three-phase sensing for applications with greatly unbalanced or highly non-linear loads.

MX321 AVR

The most sophisticated of all our AVRs combines all the features of the MX341 with, additionally, three-phase rms sensing, for improved regulation and performance.

Over voltage protection is built-in and short circuit current level adjustments is an optional facility.

WINDINGS & ELECTRICAL PERFORMANCE

All generator stators are wound to 2/3 pitch. This eliminates triplen (3rd, 9th, 15th ...) harmonics on the voltage waveform and is found to be the optimum design for trouble-free supply of non-linear loads. The 2/3 pitch design avoids excessive neutral currents sometimes seen with higher winding pitches, when in parallel with the mains. A fully connected damper winding reduces oscillations during paralleling. This winding, with the 2/3 pitch and carefully selected pole and tooth designs, ensures very low waveform distortion.

TERMINALS & TERMINAL BOX

Standard generators are 3-phase reconnectable with 12 ends brought out to the terminals, which are mounted on a cover at the non-drive end of the generator. A sheet steel terminal box contains the AVR and provides ample space for the customers' wiring and gland arrangements. It has removable panels for easy access.

SHAFT & KEYS

All generator rotors are dynamically balanced to better than BS6861:Part 1 Grade 2.5 for minimum vibration in operation. Two bearing generators are balanced with a half key.

INSULATION/IMPREGNATION

The insulation system is class 'H'.

All wound components are impregnated with materials and processes designed specifically to provide the high build required for static windings and the high mechanical strength required for rotating components.

QUALITY ASSURANCE

Generators are manufactured using production procedures having a quality assurance level to BS EN ISO 9001.

The stated voltage regulation may not be maintained in the presence of certain radio transmitted signals. Any change in performance will fall within the limits of Criteria 'B' of EN 61000-6-2:2001. At no time will the steady-state voltage regulation exceed 2%.

NB Continuous development of our products entitles us to change specification details without notice, therefore they must not be regarded as binding.

Front cover drawing typical of product range.

UCI224D



WINDING 311

CONTROL SYSTEM		SEPARATELY EXCITED BY P.M.G.							
A.V.R.		MX321	MX341						
VOLTAGE REGULATION		± 0.5 %	± 1.0 %	With 4% ENGINE GOVERNING					
SUSTAINED SHORT CIRCUIT		REFER TO SHORT CIRCUIT DECREMENT CURVES (page 7)							
CONTROL SYSTEM		SELF EXCITED							
A.V.R.		SX460	AS440						
VOLTAGE REGULATION		± 1.0 %	± 1.0 %	With 4% ENGINE GOVERNING					
SUSTAINED SHORT CIRCUIT		SERIES 4 CONTROL DOES NOT SUSTAIN A SHORT CIRCUIT CURRENT							
INSULATION SYSTEM		CLASS H							
PROTECTION		IP23							
RATED POWER FACTOR		0.8							
STATOR WINDING		DOUBLE LAYER CONCENTRIC							
WINDING PITCH		TWO THIRDS							
WINDING LEADS		12							
STATOR WDG. RESISTANCE		0.129 Ohms PER PHASE AT 22°C SERIES STAR CONNECTED							
ROTOR WDG. RESISTANCE		0.64 Ohms at 22°C							
EXCITER STATOR RESISTANCE		21 Ohms at 22°C							
EXCITER ROTOR RESISTANCE		0.071 Ohms PER PHASE AT 22°C							
R.F.I. SUPPRESSION		BS EN 61000-6-2 & BS EN 61000-6-4, VDE 0875G, VDE 0875N. refer to factory for others							
WAVEFORM DISTORTION		NO LOAD < 1.5% NON-DISTORTING BALANCED LINEAR LOAD < 5.0%							
MAXIMUM OVERSPEED		2250 Rev/Min							
BEARING DRIVE END		BALL. 6312-2RS (ISO)							
BEARING NON-DRIVE END		BALL. 6309-2RS (ISO)							
		1 BEARING				2 BEARING			
WEIGHT COMP. GENERATOR		285 kg				290 kg			
WEIGHT WOUND STATOR		86 kg				86 kg			
WEIGHT WOUND ROTOR		86.28 kg				77.9 kg			
WR ² INERTIA		0.4216 kgm ²				0.4198 kgm ²			
SHIPPING WEIGHTS in a crate		307 kg				311 kg			
PACKING CRATE SIZE		97 x 57 x 96(cm)				97 x 57 x 96(cm)			
		50 Hz				60 Hz			
TELEPHONE INTERFERENCE		THF<2%				TIF<50			
COOLING AIR		0.216 m ³ /sec 458 cfm				0.281 m ³ /sec 595 cfm			
VOLTAGE SERIES STAR		380/220	400/231	415/240	440/254	416/240	440/254	460/266	480/277
VOLTAGE PARALLEL STAR		190/110	200/115	208/120	220/127	208/120	220/127	230/133	240/138
VOLTAGE SERIES DELTA		220/110	230/115	240/120	254/127	240/120	254/127	266/133	277/138
KVA BASE RATING FOR REACTANCE VALUES		50	50	50	48	60	62.5	62.5	65
Xd DIR. AXIS SYNCHRONOUS		2.33	2.10	1.95	1.67	3.04	2.83	2.59	2.47
X'd DIR. AXIS TRANSIENT		0.18	0.16	0.15	0.13	0.22	0.20	0.19	0.18
X''d DIR. AXIS SUBTRANSIENT		0.12	0.11	0.10	0.09	0.15	0.14	0.13	0.12
Xq QUAD. AXIS REACTANCE		1.07	0.97	0.90	0.77	1.40	1.30	1.19	1.14
X''q QUAD. AXIS SUBTRANSIENT		0.14	0.13	0.12	0.10	0.14	0.13	0.12	0.11
XL LEAKAGE REACTANCE		0.07	0.06	0.06	0.05	0.09	0.08	0.08	0.07
X ₂ NEGATIVE SEQUENCE		0.13	0.12	0.11	0.09	0.14	0.13	0.12	0.11
X ₀ ZERO SEQUENCE		0.08	0.08	0.07	0.06	0.09	0.08	0.08	0.07
REACTANCES ARE SATURATED		VALUES ARE PER UNIT AT RATING AND VOLTAGE INDICATED							
T'd TRANSIENT TIME CONST.		0.027 s							
T''d SUB-TRANSTIME CONST.		0.006 s							
T'do O.C. FIELD TIME CONST.		0.7 s							
Ta ARMATURE TIME CONST.		0.0055 s							
SHORT CIRCUIT RATIO		1/Xd							

50
Hz

UCI224D
Winding 311

STAMFORD

THREE PHASE EFFICIENCY CURVES

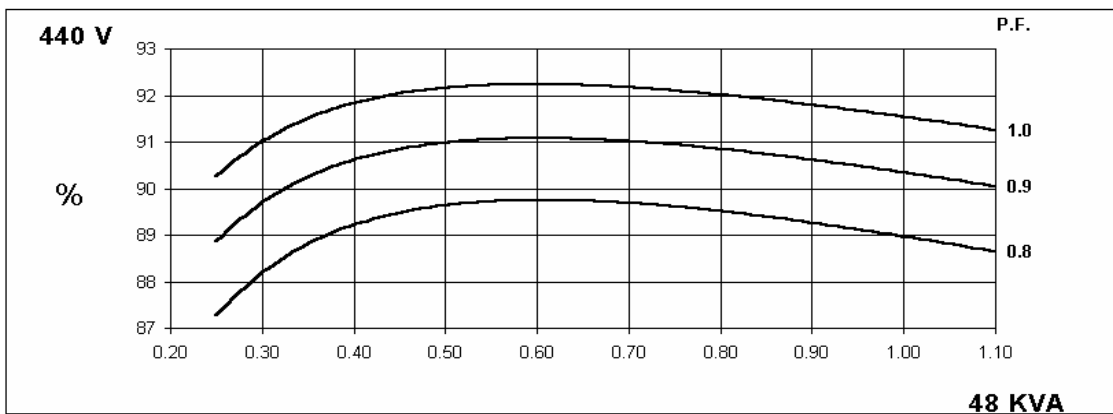
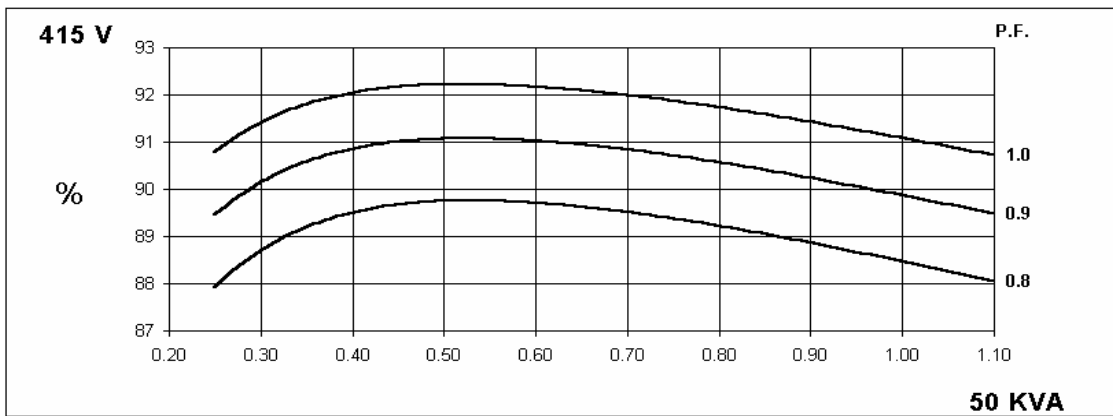
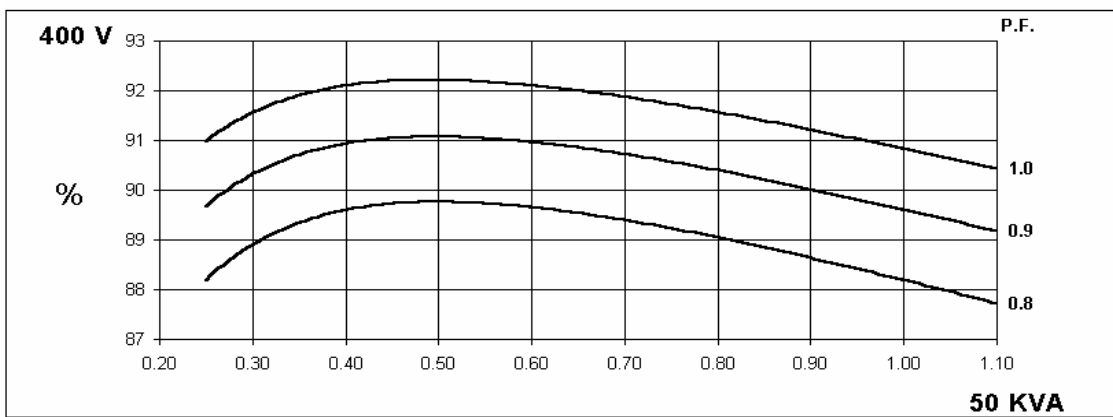
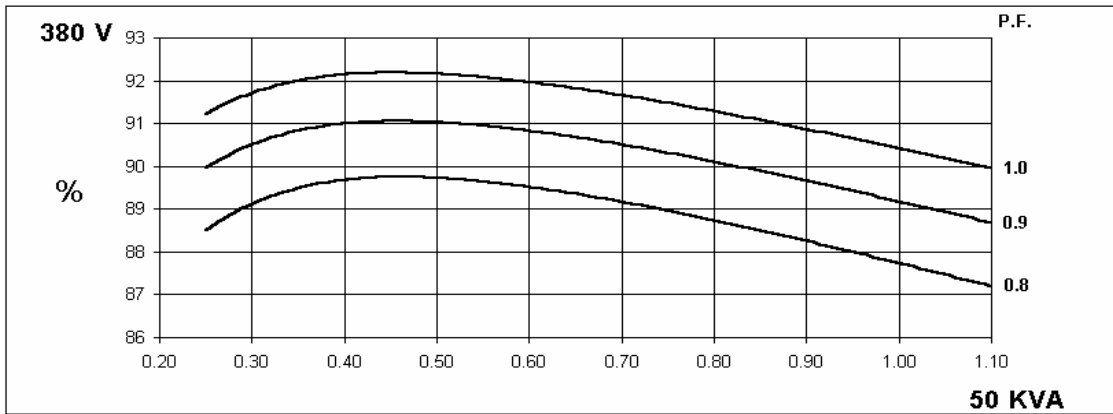

60
Hz

UCI224D
Winding 311

STAMFORD

THREE PHASE EFFICIENCY CURVES

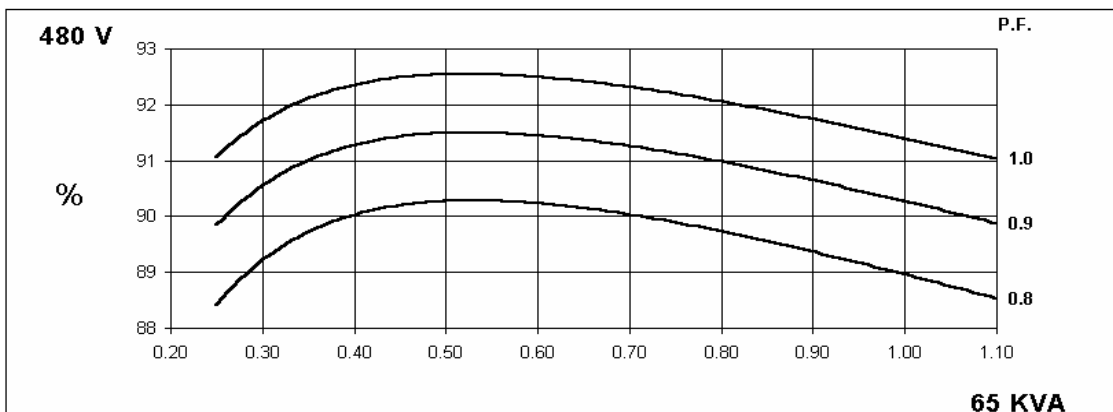
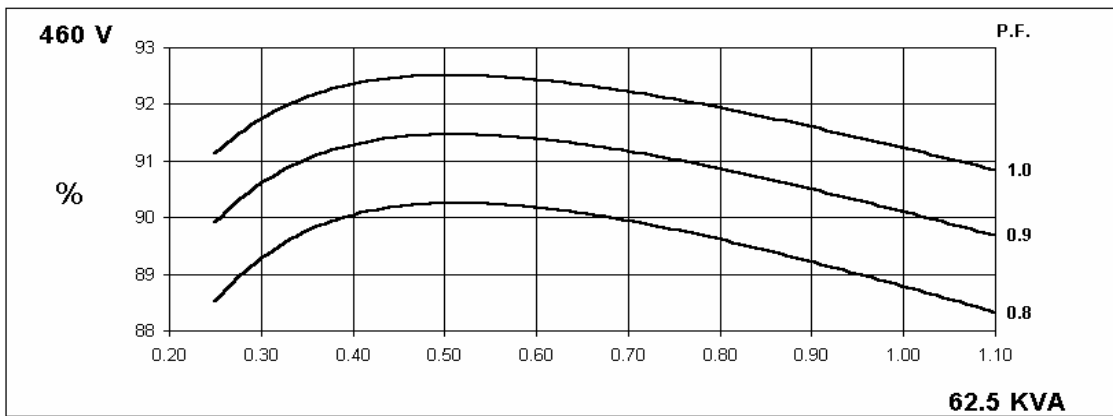
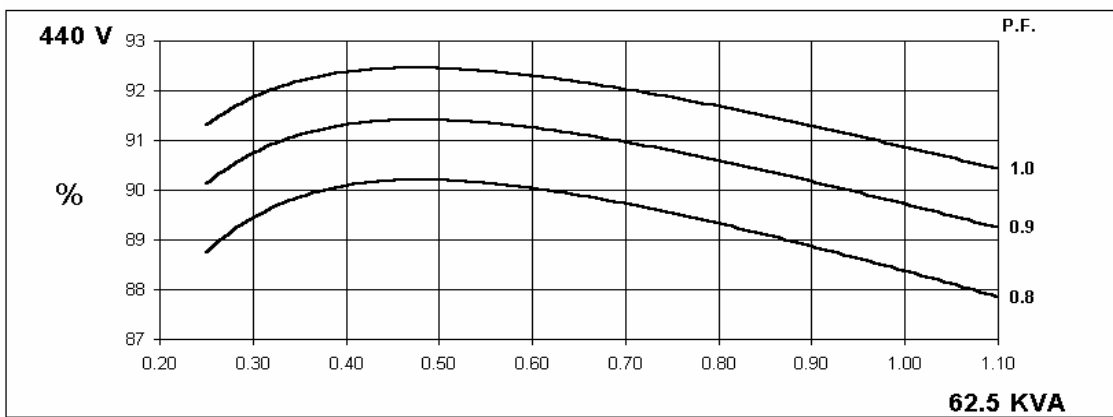
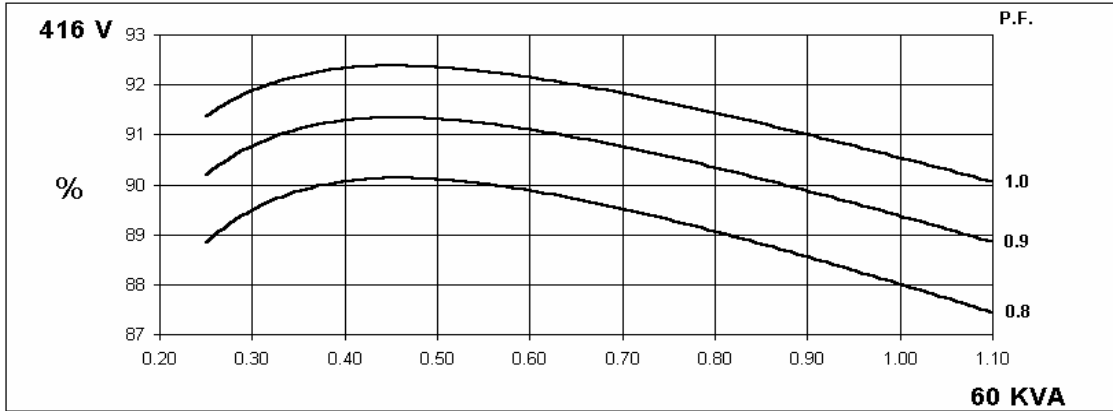

UCI224D
Winding 311

STAMFORD

Locked Rotor Motor Starting Curve

50
Hz

MX

SX

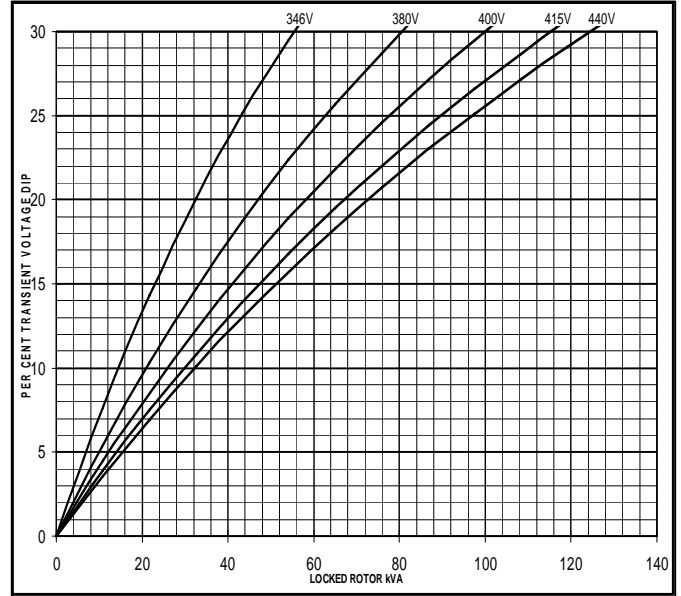
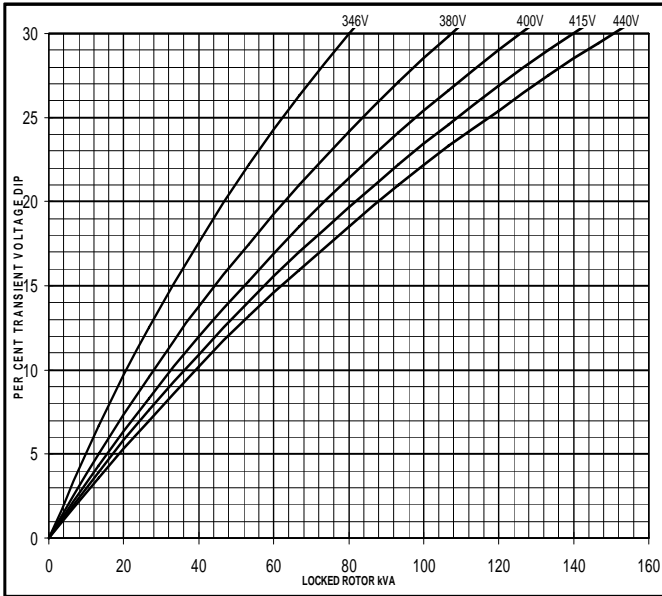

60
Hz

MX

SX

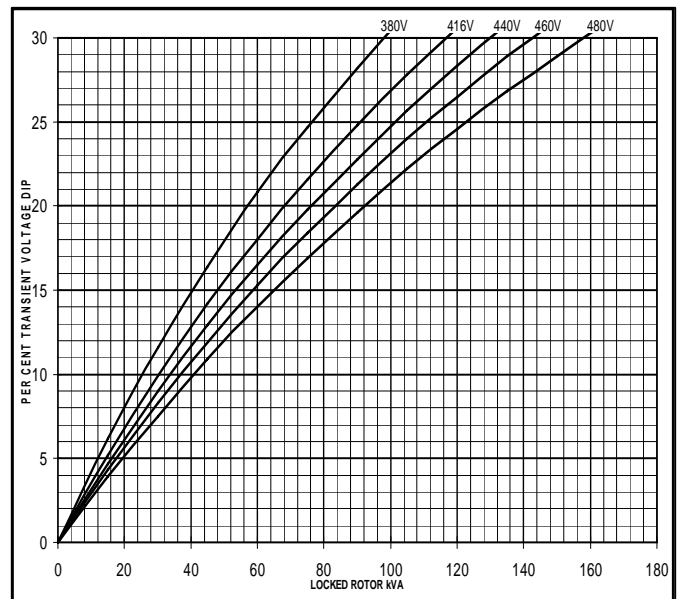
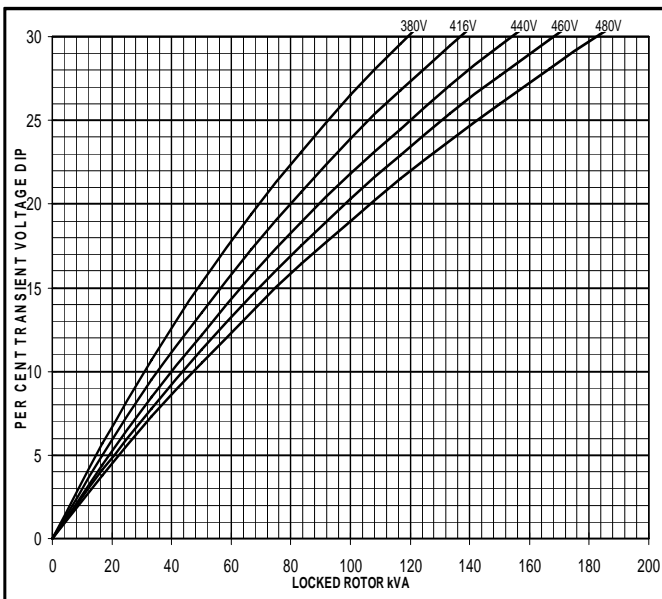

**Three-phase Short Circuit Decrement Curve. No-load Excitation at Rated Speed
Based on star (wye) connection.**

50
Hz

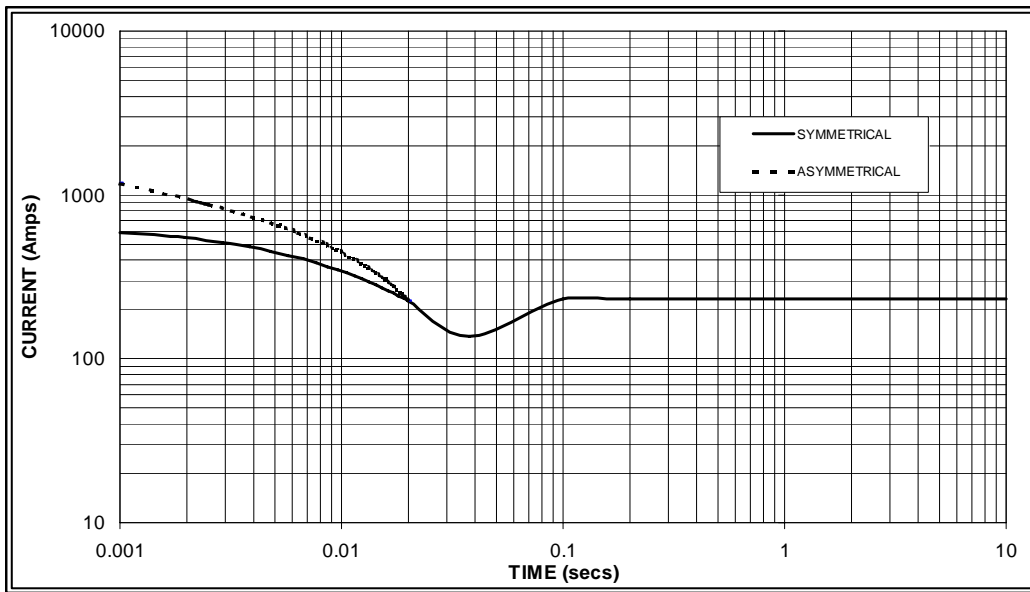

Sustained Short Circuit = 230 Amps

60
Hz

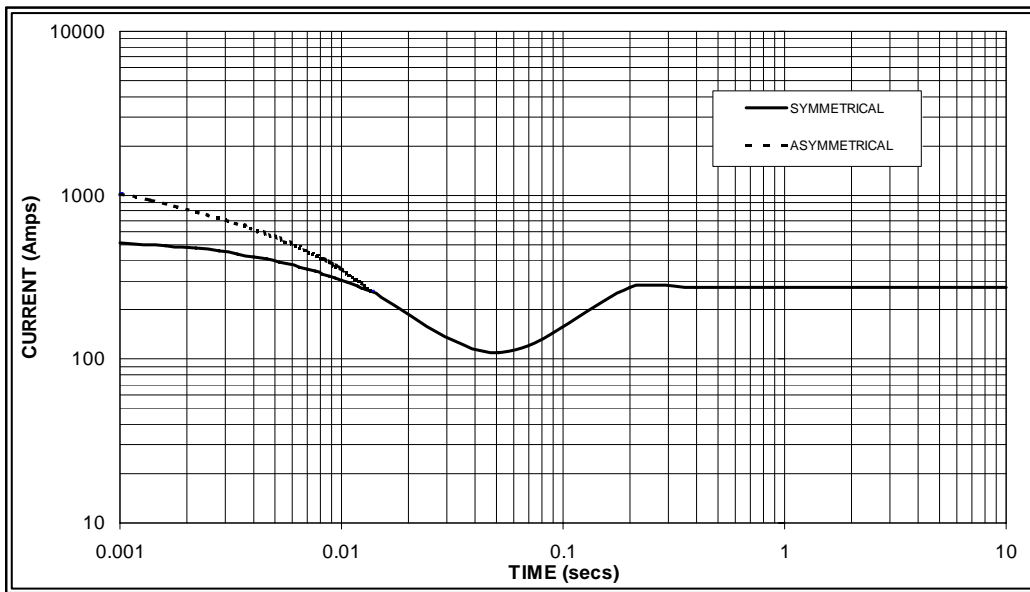

Sustained Short Circuit = 275 Amps

Note 1

The following multiplication factors should be used to adjust the values from curve between time 0.001 seconds and the minimum current point in respect of nominal operating voltage :

50Hz		60Hz	
Voltage	Factor	Voltage	Factor
380v	X 1.00	416v	X 1.00
400v	X 1.07	440v	X 1.06
415v	X 1.12	460v	X 1.12
440v	X 1.18	480v	X 1.17

The sustained current value is constant irrespective of voltage level

Note 2

The following multiplication factor should be used to convert the values calculated in accordance with NOTE 1 to those applicable to the various types of short circuit :

	3-phase	2-phase L-L	1-phase L-N
Instantaneous	x 1.00	x 0.87	x 1.30
Minimum	x 1.00	x 1.80	x 3.20
Sustained	x 1.00	x 1.50	x 2.50
Max. sustained duration	10 sec.	5 sec.	2 sec.

All other times are unchanged

Note 3

Curves are drawn for Star (Wye) connected machines. For other connection the following multipliers should be applied to current values as shown :

Parallel Star = Curve current value X 2

Series Delta = Curve current value X 1.732

UCI224D

STAMFORD

Winding 311 / 0.8 Power Factor

RATINGS

Class - Temp Rise	Cont. F - 105/40°C				Cont. H - 125/40°C				Standby - 150/40°C				Standby - 163/27°C				
50 Hz	Series Star (V)	380	400	415	440	380	400	415	440	380	400	415	440	380	400	415	440
	Parallel Star (V)	190	200	208	220	190	200	208	220	190	200	208	220	190	200	208	220
	Series Delta (V)	220	230	240	254	220	230	240	254	220	230	240	254	220	230	240	254
kVA	45.0	45.0	45.0	33.6	50.0	50.0	50.0	37.5	53.0	53.0	53.0	39.1	55.0	55.0	55.0	41.2	
kW	36.0	36.0	36.0	26.9	40.0	40.0	40.0	30.0	42.4	42.4	42.4	31.3	44.0	44.0	44.0	33.0	
Efficiency (%)	88.3	88.6	88.9	89.3	87.7	88.2	88.5	89.0	87.4	87.9	88.2	88.8	87.2	87.7	88.0	88.6	
kW Input	40.8	40.6	40.5	38.5	45.6	45.4	45.2	43.1	48.5	48.2	48.1	45.0	50.5	50.2	50.0	47.6	

60 Hz	Series Star (V)	416	440	460	480	416	440	460	480	416	440	460	480	416	440	460	480
	Parallel Star (V)	208	220	230	240	208	220	230	240	208	220	230	240	208	220	230	240
	Delta (V)	240	254	266	277	240	254	266	277	240	254	266	277	240	254	266	277
kVA	52.5	55.0	56.0	58.0	60.0	62.5	62.5	65.0	62.5	65.0	65.0	68.8	65.0	66.3	66.3	71.3	
kW	42.0	44.0	44.8	46.4	48.0	50.0	50.0	52.0	50.0	52.0	52.0	55.0	52.0	53.0	53.0	57.0	
Efficiency (%)	88.7	89.0	89.2	89.4	88.0	88.4	88.8	89.0	87.8	88.2	88.6	88.7	87.5	88.1	88.5	88.5	
kW Input	47.4	49.4	50.2	51.9	54.5	56.6	56.3	58.4	56.9	59.0	58.7	62.1	59.4	60.2	59.9	64.5	

DIMENSIONS

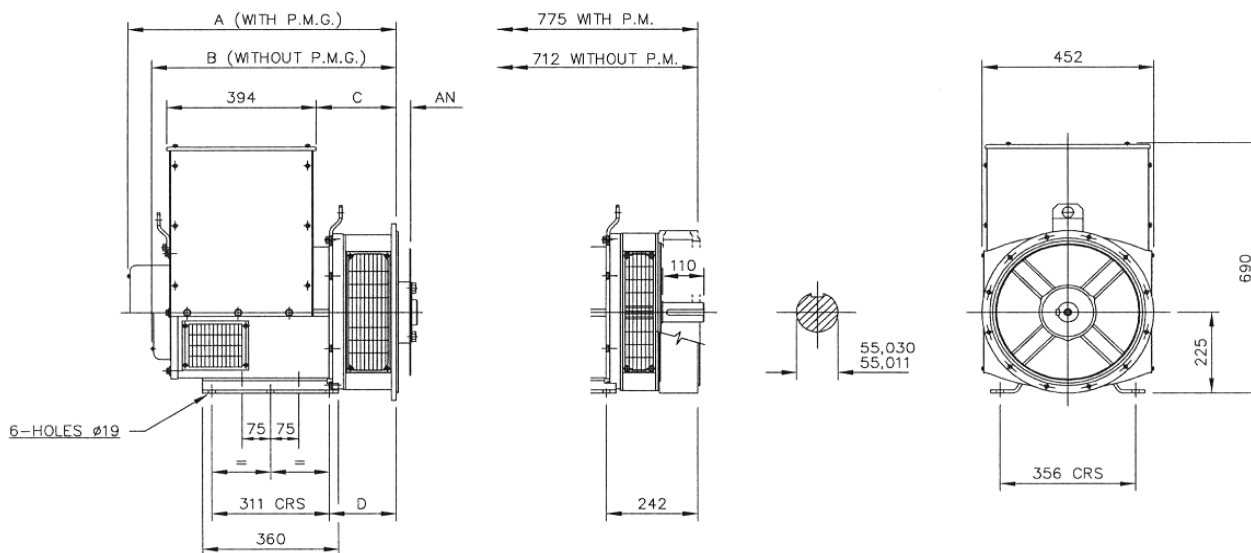

SINGLE BEARING MACHINES ONLY						
ADAPTOR	A	B	C	D	COUPLING DISCS	AN
SAE 1	724,3	661,3	224,3	191,3	SAE 8	61,90
SAE 2	710	647	210	177	SAE 10	53,98
SAE 3	710	647	210	177	SAE 11,5	39,68
SAE 4	710	647	210	177	SAE 14	25,40

STAMFORD

Barnack Road • Stamford • Lincolnshire • PE9 2NB

Tel: 00 44 (0)1780 484000 • Fax: 00 44 (0)1780 484100

6BTA5.9-G5

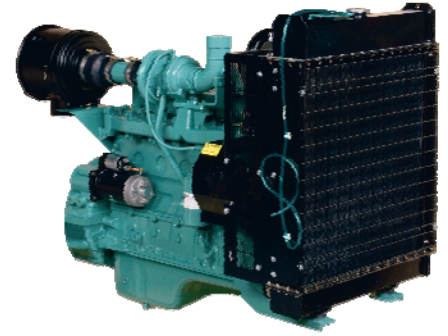

> Specification sheet



Our energy working for you.™

Description

The B5.9 engine has established an unrivalled reputation for reliability, incorporating features designed to maximise engine integration within OEM installation.

This engine has been built to comply with CE certification.

This engine has been designed in facilities certified to ISO9001 and manufactured in facilities certified to ISO9001 or ISO 9002 or TS16949.



Features

Single Poly Vee belt drive for fan, alternator and water pump, with self-tensioning idler for minimum maintenance.

Inline-type Bosch A-Series pump operates at high injection pressures for cleaner combustion and lower emissions.

Spin-on fuel filter and full-flow lubricating oil filter.

Top mounted Holset HX35 turbocharger for increased power, fuel economy, and lower smoke and noise levels.

Coolpac Integrated Design - Products are supplied complete with cooling package and air cleaner kit for a complete power package. Each component has been specifically developed and rigorously tested for G-Drive products, ensuring high performance, durability and reliability.

Service and Support - G-Drive products are backed by an uncompromising level of technical support and after sales service, delivered through a world class service network.

1500 rpm (50 Hz Ratings)

Gross Engine Output			Net Engine Output			Typical Generator Set Output					
Standby	Prime	Base	Standby	Prime	Base	Standby (ESP)		Prime (PRP)		Base (COP)	
kWm/BHP			kWm/BHP			kWe	kVA	kWe	kVA	kWe	kVA
102/137	93/125	82/110	98/131	90/121	79/106	88	110	80	100	64	80



General Engine Data

Type	4 cycle, in-line, Turbo Charged
Bore mm	102 mm (4.02 in.)
Stroke mm	120 mm (4.72 in.)
Displacement Litre	5.9 litre (359.0 in. ³)
Cylinder Block	Cast iron, 6 cylinder
Battery Charging Alternator	55 amps
Starting Voltage	12 volt, 55 Amp negative ground
Fuel System	Direct injection
Fuel Filter	Spin-on fuel filters with water separator
Lube Oil Filter Type(s)	Spin-on full flow filter
Lube Oil Capacity (l)	16.4
Flywheel Dimensions	3/11.5

Coolpac Performance Data

Cooling System Design	Jacket Water After Cooled
Coolant Ratio	50% ethylene glycol; 50% water
Coolant Capacity (l)	19.75
Limiting Ambient Temp.**	56.0
Fan Power(hp)	10.7
Cooling System Air Flow (m ³ /s)**	3.59
Air Cleaner Type (Normal Duty)	Dry replaceable element with restriction indicator

** @ 13 mm H₂O at 100% Prime

Weight & Dimensions

	Length	Width	Height	Weight (dry)
	mm	mm	mm	kg
Engine only*	1065	698	981	402
Coolpac	1526	817	1262	505

*Fan to flywheel

Fuel Consumption 1500 (50 Hz)

%	kWm	BHP	L/ph	US gal/ph
Standby Power				
100	102	137	27	7.2
Prime Power				
100	93	125	25	6.6
75	70	94	18	4.8
50	47	63	12	3.3
25	23	31	7	1.9
Continuous Power				
100	82	110	21	5.6

Cummins G Drive Engines

Asia Pacific

10 Toh Guan Road
#07-01
TT International Tradepark
Singapore 608838
Phone 65 6417 2388
Fax 65 6417 2399

Europe, CIS, Middle East and Africa

Manston Park Columbus Ave
Manston Ramsgate
Kent CT12 5BF. UK
Phone 44 1843 255000
Fax 44 1843 255902

Latin America

Rua Jati, 310, Cumbica
Guarulhos, SP 07180-900
Brazil
Phone 55 11 2186 4552
Fax 55 11 2186 4729

Mexico

Cummins S. de R.L. de C.V.
Eje 122 No. 200 Zona Industrial
San Luis Potosí, S.L.P. 78090
Mexico
Phone 52 444 870 6700
Fax 52 444 870 6811

North America

1400 73rd Avenue N.E.
Minneapolis, MN 55432
USA
Phone 1 763 574 5000
USA Toll-free 1 877 769 7669
Fax 1 763 574 5298

Ratings Definitions

Emergency Standby Power (ESP):

Applicable for supplying power to varying electrical load for the duration of power interruption of a reliable utility source. Emergency Standby Power (ESP) is in accordance with ISO 8528. Fuel Stop power in accordance with ISO 3046, AS 2789, DIN 6271 and BS 5514.

Limited-Time Running Power (LTP):

Applicable for supplying power to a constant electrical load for limited hours. Limited-Time Running Power (LTP) is in accordance with ISO 8528.

Prime Power (PRP):

Applicable for supplying power to varying electrical load for unlimited hours. Prime Power (PRP) is in accordance with ISO 8528. Ten percent overload capability is available in accordance with ISO 3046, AS 2789, DIN 6271 and BS 5514.

Base Load (Continuous) Power (COP):

Applicable for supplying power continuously to a constant electrical load for unlimited hours. Continuous Power (COP) in accordance with ISO 8528, ISO 3046, AS 2789, DIN6271 and BS 5514.



STAMFORD®

UCI274C - Technical Data Sheet

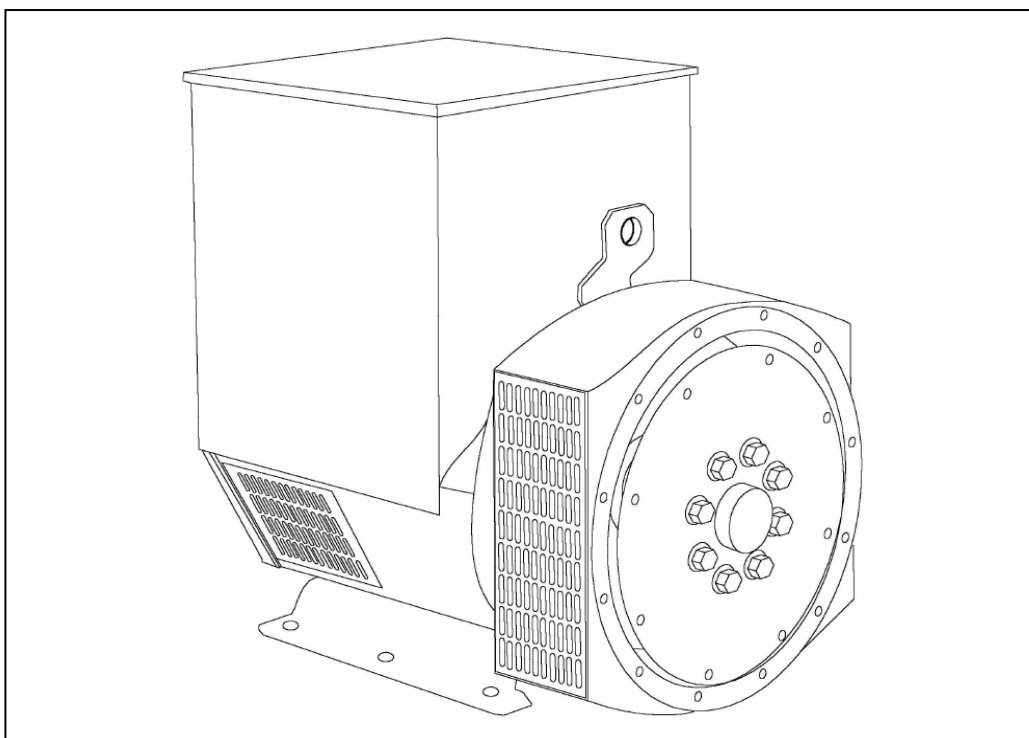

UCI274C

SPECIFICATIONS & OPTIONS

STAMFORD

STANDARDS

Newage Stamford industrial generators meet the requirements of BS EN 60034 and the relevant section of other international standards such as BS5000, VDE 0530, NEMA MG1-32, IEC34, CSA C22.2-100, AS1359. Other standards and certifications can be considered on request.

VOLTAGE REGULATORS

SX460 AVR - STANDARD

With this self excited control system the main stator supplies power via the Automatic Voltage Regulator (AVR) to the exciter stator. The high efficiency semiconductors of the AVR ensure positive build-up from initial low levels of residual voltage.

The exciter rotor output is fed to the main rotor through a three phase full wave bridge rectifier. This rectifier is protected by a surge suppressor against surges caused, for example, by short circuit.

AS440 AVR

With this self-excited system the main stator provides power via the AVR to the exciter stator. The high efficiency semi-conductors of the AVR ensure positive build-up from initial low levels of residual voltage.

The exciter rotor output is fed to the main rotor through a three-phase full-wave bridge rectifier. The rectifier is protected by a surge suppressor against surges caused, for example, by short circuit or out-of-phase paralleling.

The AS440 will support a range of electronic accessories, including a 'droop' Current Transformer (CT) to permit parallel operation with other ac generators.

MX341 AVR

This sophisticated AVR is incorporated into the Stamford Permanent Magnet Generator (PMG) control system.

The PMG provides power via the AVR to the main exciter, giving a source of constant excitation power independent of generator output. The main exciter output is then fed to the main rotor, through a full wave bridge, protected by a surge suppressor. The AVR has in-built protection against sustained over-excitation, caused by internal or external faults. This de-excites the machine after a minimum of 5 seconds.

An engine relief load acceptance feature can enable full load to be applied to the generator in a single step.

If three-phase sensing is required with the PMG system the MX321 AVR must be used.

We recommend three-phase sensing for applications with greatly unbalanced or highly non-linear loads.

MX321 AVR

The most sophisticated of all our AVRs combines all the features of the MX341 with, additionally, three-phase rms sensing, for improved regulation and performance.

Over voltage protection is built-in and short circuit current level adjustments is an optional facility.

WINDINGS & ELECTRICAL PERFORMANCE

All generator stators are wound to 2/3 pitch. This eliminates triplen (3rd, 9th, 15th ...) harmonics on the voltage waveform and is found to be the optimum design for trouble-free supply of non-linear loads. The 2/3 pitch design avoids excessive neutral currents sometimes seen with higher winding pitches, when in parallel with the mains. A fully connected damper winding reduces oscillations during paralleling. This winding, with the 2/3 pitch and carefully selected pole and tooth designs, ensures very low waveform distortion.

TERMINALS & TERMINAL BOX

Standard generators are 3-phase reconnectable with 12 ends brought out to the terminals, which are mounted on a cover at the non-drive end of the generator. A sheet steel terminal box contains the AVR and provides ample space for the customers' wiring and gland arrangements. It has removable panels for easy access.

SHAFT & KEYS

All generator rotors are dynamically balanced to better than BS6861:Part 1 Grade 2.5 for minimum vibration in operation. Two bearing generators are balanced with a half key.

INSULATION/IMPREGNATION

The insulation system is class 'H'.

All wound components are impregnated with materials and processes designed specifically to provide the high build required for static windings and the high mechanical strength required for rotating components.

QUALITY ASSURANCE

Generators are manufactured using production procedures having a quality assurance level to BS EN ISO 9001.

The stated voltage regulation may not be maintained in the presence of certain radio transmitted signals. Any change in performance will fall within the limits of Criteria 'B' of EN 61000-6-2:2001. At no time will the steady-state voltage regulation exceed 2%.

NB Continuous development of our products entitles us to change specification details without notice, therefore they must not be regarded as binding.

Front cover drawing typical of product range.

WINDING 311

CONTROL SYSTEM	SEPARATELY EXCITED BY P.M.G.							
A.V.R.	MX321	MX341						
VOLTAGE REGULATION	± 0.5 %	± 1.0 %	With 4% ENGINE GOVERNING					
SUSTAINED SHORT CIRCUIT	REFER TO SHORT CIRCUIT DECREMENT CURVES (page 7)							
CONTROL SYSTEM	SELF EXCITED							
A.V.R.	SX460	AS440						
VOLTAGE REGULATION	± 1.0 %	± 1.0 %	With 4% ENGINE GOVERNING					
SUSTAINED SHORT CIRCUIT	SERIES 4 CONTROL DOES NOT SUSTAIN A SHORT CIRCUIT CURRENT							
INSULATION SYSTEM	CLASS H							
PROTECTION	IP23							
RATED POWER FACTOR	0.8							
STATOR WINDING	DOUBLE LAYER CONCENTRIC							
WINDING PITCH	TWO THIRDS							
WINDING LEADS	12							
STATOR WDG. RESISTANCE	0.059 Ohms PER PHASE AT 22°C SERIES STAR CONNECTED							
ROTOR WDG. RESISTANCE	1.12 Ohms at 22°C							
EXCITER STATOR RESISTANCE	20 Ohms at 22°C							
EXCITER ROTOR RESISTANCE	0.091 Ohms PER PHASE AT 22°C							
R.F.I. SUPPRESSION	BS EN 61000-6-2 & BS EN 61000-6-4, VDE 0875G, VDE 0875N. refer to factory for others							
WAVEFORM DISTORTION	NO LOAD < 1.5% NON-DISTORTING BALANCED LINEAR LOAD < 5.0%							
MAXIMUM OVERSPEED	2250 Rev/Min							
BEARING DRIVE END	BALL. 6315-2RS (ISO)							
BEARING NON-DRIVE END	BALL. 6310-2RS (ISO)							
	1 BEARING				2 BEARING			
WEIGHT COMP. GENERATOR	406 kg				420 kg			
WEIGHT WOUND STATOR	131 kg				131 kg			
WEIGHT WOUND ROTOR	133.78 kg				122.82 kg			
WR ² INERTIA	1.0288 kgm ²				0.9781 kgm ²			
SHIPPING WEIGHTS in a crate	439 kg				452 kg			
PACKING CRATE SIZE	105 x 67 x 103(cm)				105 x 67 x 103(cm)			
	50 Hz				60 Hz			
TELEPHONE INTERFERENCE	THF<2%				TIF<50			
COOLING AIR	0.514 m ³ /sec 1090 cfm				0.617 m ³ /sec 1308 cfm			
VOLTAGE SERIES STAR	380/220	400/231	415/240	440/254	416/240	440/254	460/266	480/277
VOLTAGE PARALLEL STAR	190/110	200/115	208/120	220/127	208/120	220/127	230/133	240/138
VOLTAGE SERIES DELTA	220/110	230/115	240/120	254/127	240/120	254/127	266/133	277/138
KVA BASE RATING FOR REACTANCE VALUES	100	100	100	N/A	112.5	117.5	117.5	125
X _d DIR. AXIS SYNCHRONOUS	2.45	2.21	2.05	-	2.76	2.58	2.36	2.30
X' _d DIR. AXIS TRANSIENT	0.20	0.18	0.17	-	0.24	0.22	0.21	0.20
X'' _d DIR. AXIS SUBTRANSIENT	0.14	0.13	0.12	-	0.16	0.15	0.14	0.13
X _q QUAD. AXIS REACTANCE	1.59	1.43	1.33	-	1.58	1.48	1.35	1.32
X'' _q QUAD. AXIS SUBTRANSIENT	0.18	0.16	0.15	-	0.23	0.21	0.20	0.19
X _L LEAKAGE REACTANCE	0.07	0.06	0.06	-	0.08	0.07	0.07	0.07
X ₂ NEGATIVE SEQUENCE	0.16	0.14	0.13	-	0.19	0.18	0.16	0.16
X ₀ ZERO SEQUENCE	0.10	0.09	0.08	-	0.12	0.11	0.10	0.10
REACTANCES ARE SATURATED				VALUES ARE PER UNIT AT RATING AND VOLTAGE INDICATED				
T' _d TRANSIENT TIME CONST.	0.028 s							
T'' _d SUB-TRANSTIME CONST.	0.001 s							
T' _{do} O.C. FIELD TIME CONST.	0.8 s							
T _a ARMATURE TIME CONST.	0.007 s							
SHORT CIRCUIT RATIO	1/X _d							

50
Hz

UCI274C
Winding 311

STAMFORD

THREE PHASE EFFICIENCY CURVES

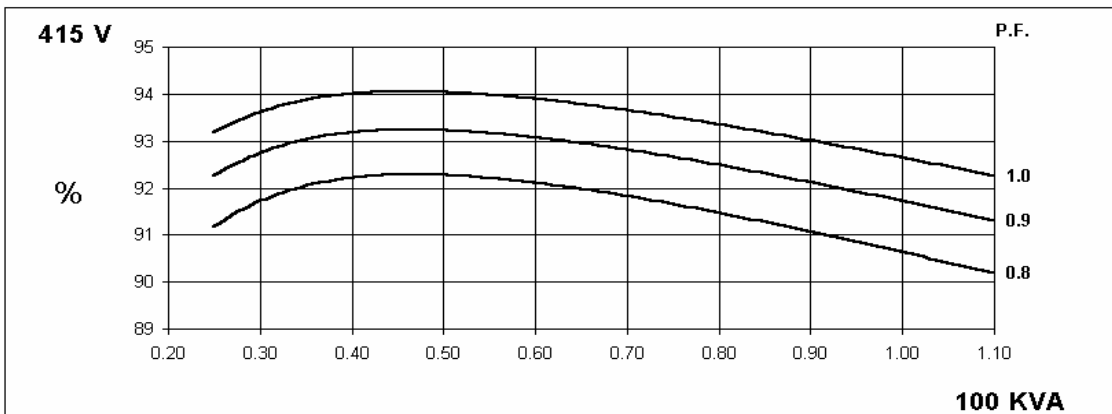
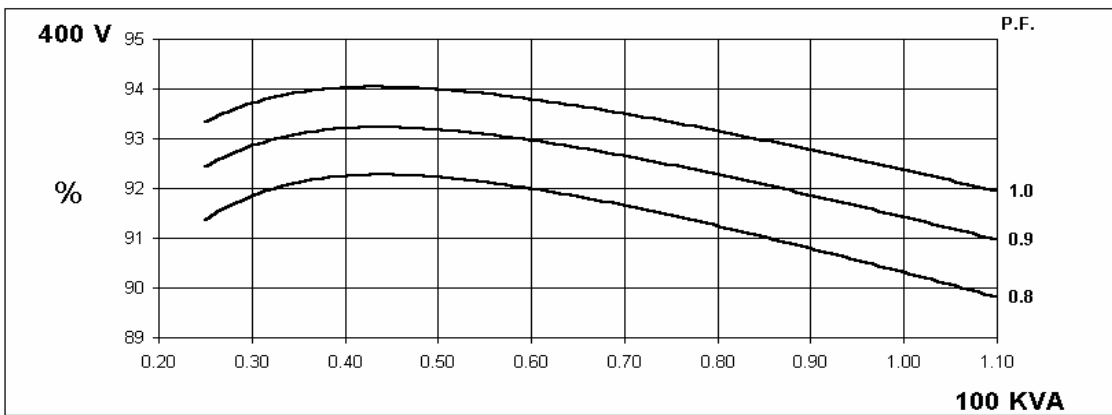
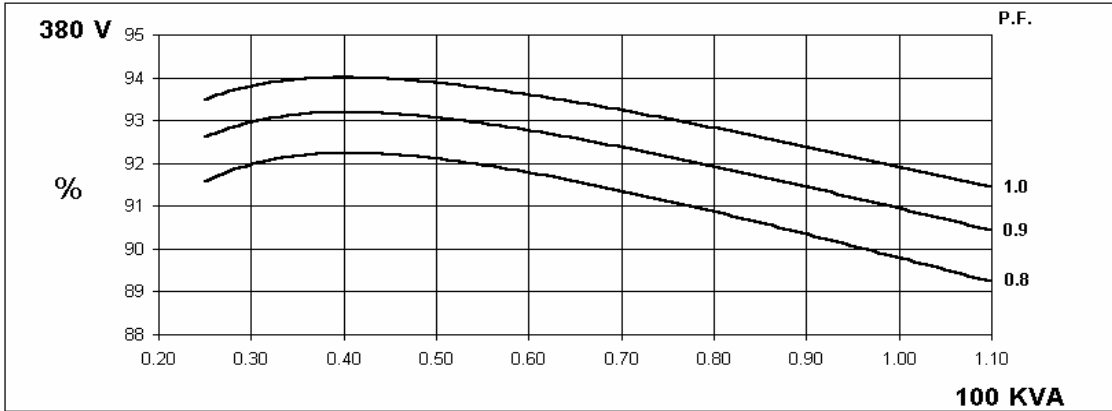

60
Hz

UCI274C
Winding 311

STAMFORD

THREE PHASE EFFICIENCY CURVES

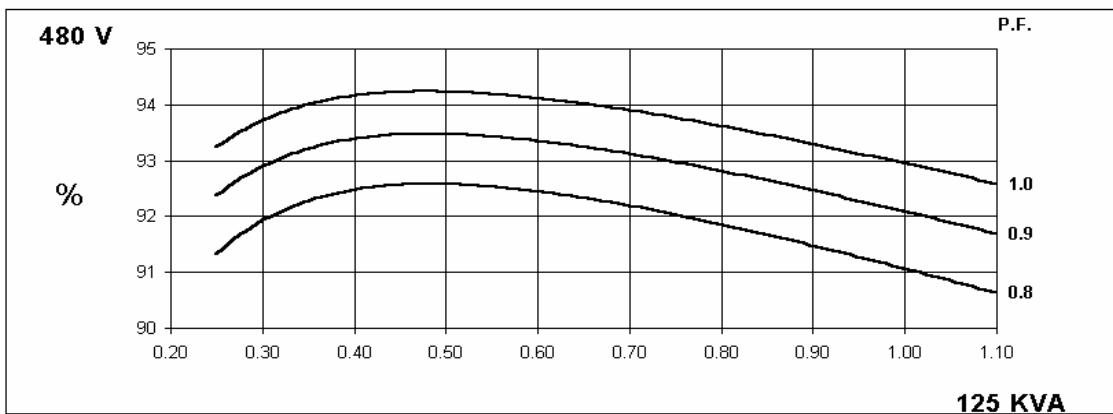
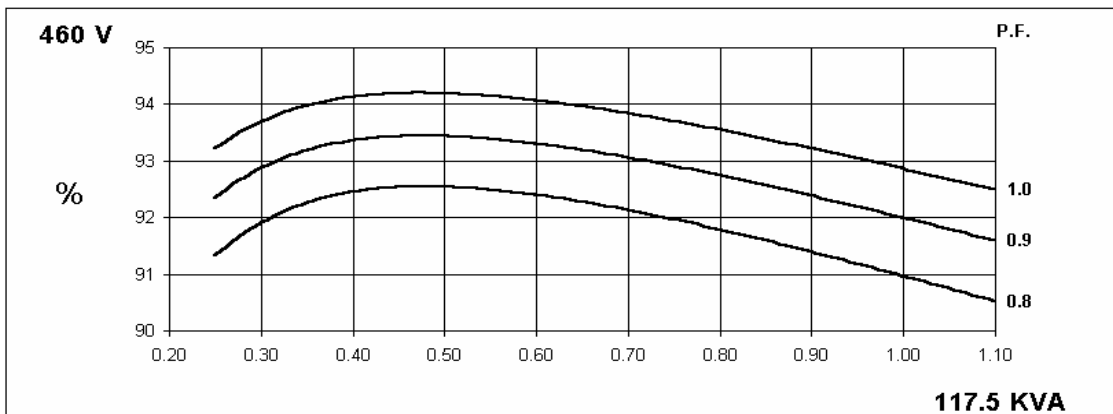
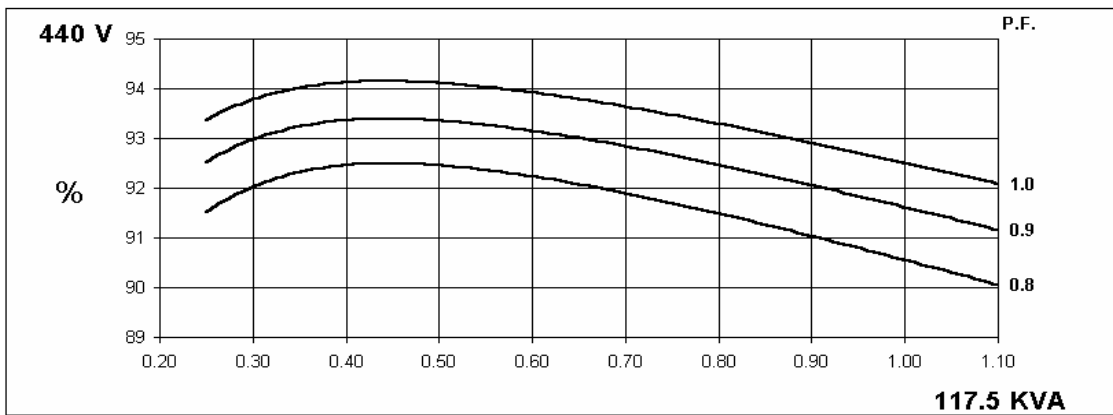
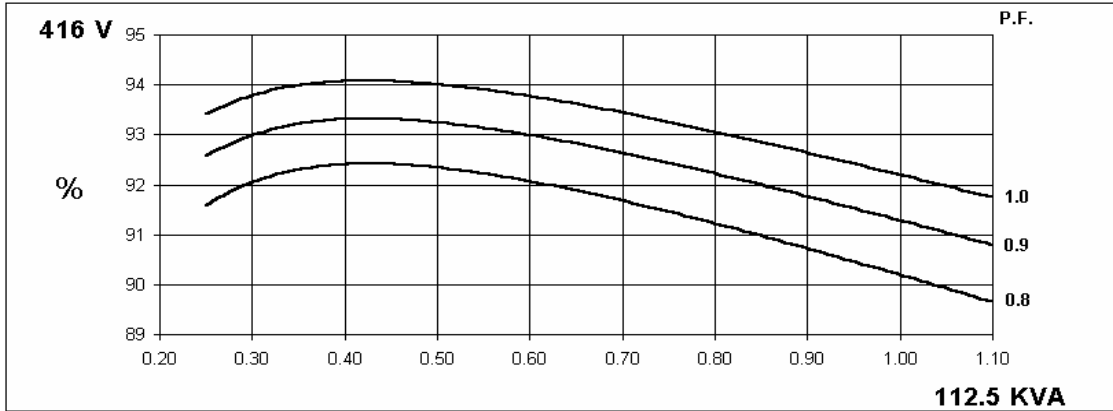

UCI274C
Winding 311

STAMFORD

Locked Rotor Motor Starting Curve

50
Hz

MX

SX

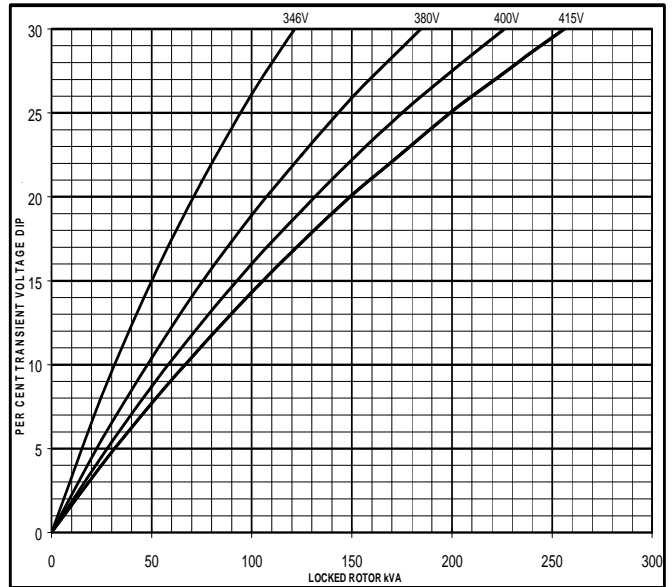
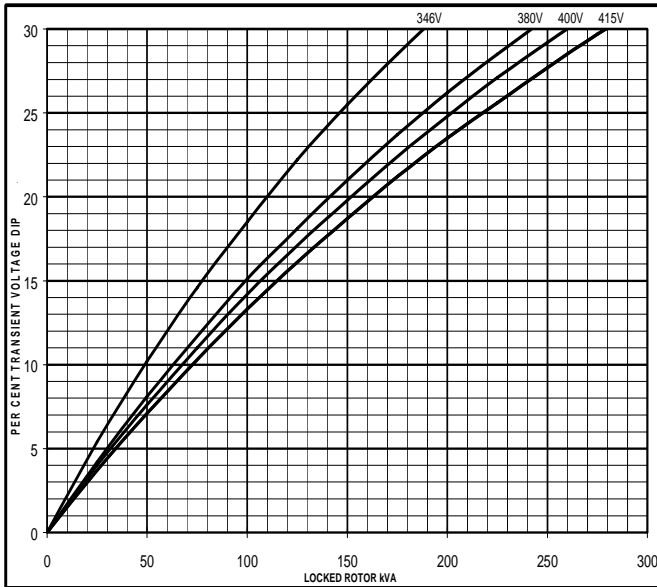

60
Hz

MX

SX

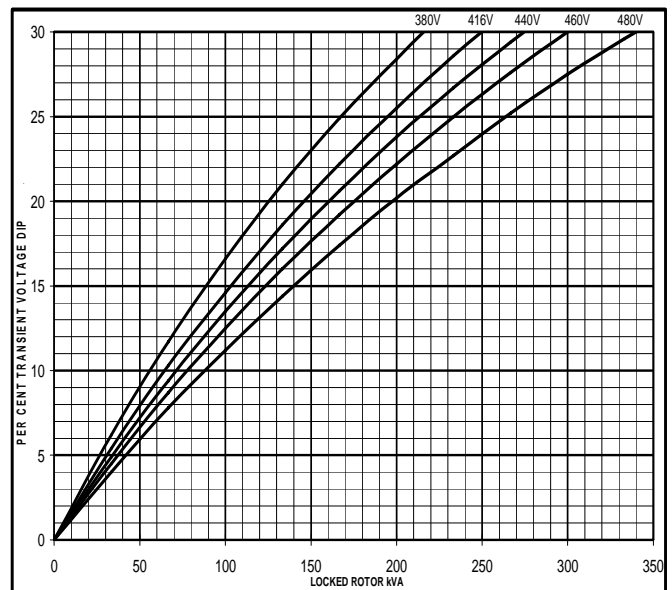
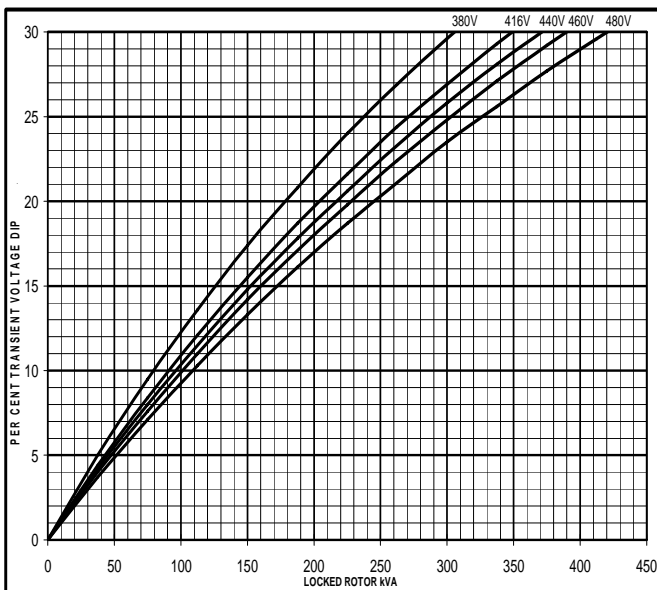

**Three-phase Short Circuit Decrement Curve. No-load Excitation at Rated Speed
Based on star (wye) connection.**

**50
Hz**

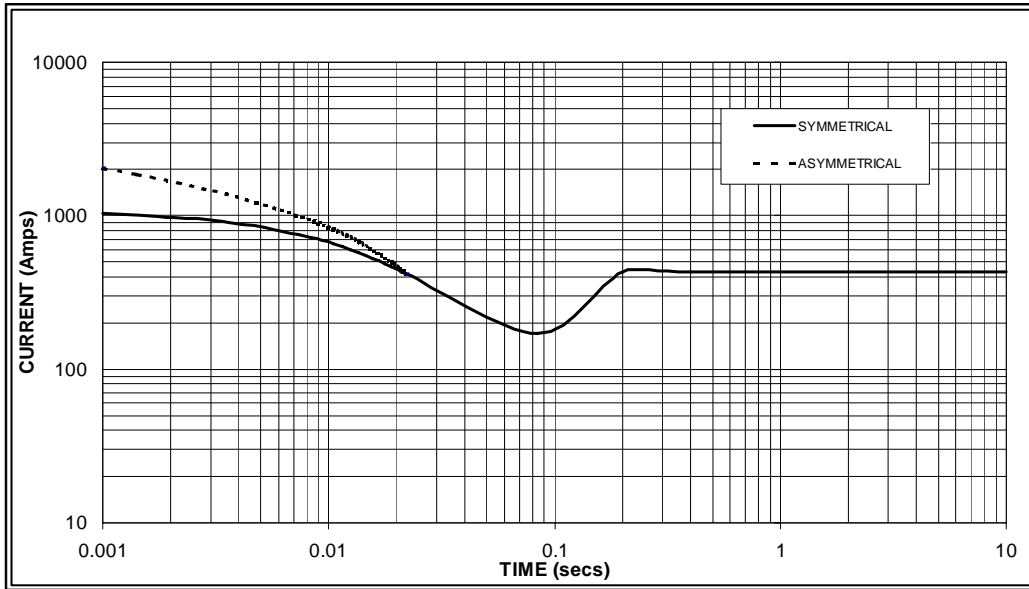

Sustained Short Circuit = 430 Amps

**60
Hz**

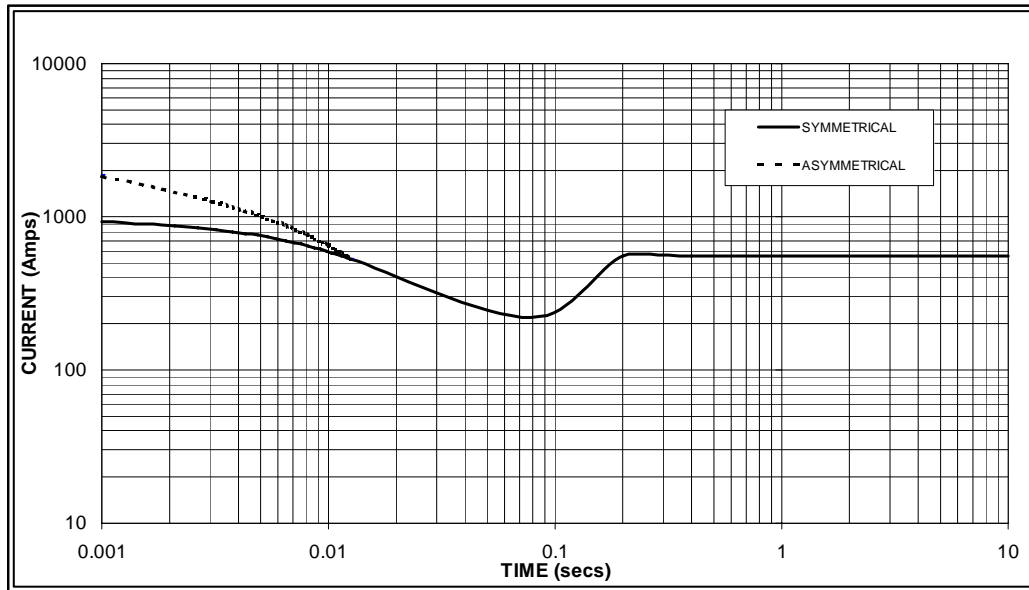

Sustained Short Circuit = 550 Amps

Note 1

The following multiplication factors should be used to adjust the values from curve between time 0.001 seconds and the minimum current point in respect of nominal operating voltage :

50Hz		60Hz	
Voltage	Factor	Voltage	Factor
380v	X 1.00	416v	X 1.00
400v	X 1.07	440v	X 1.06
415v	X 1.12	460v	X 1.12
		480v	X 1.17

The sustained current value is constant irrespective of voltage level

Note 2

The following multiplication factor should be used to convert the values calculated in accordance with NOTE 1 to those applicable to the various types of short circuit :

	3-phase	2-phase L-L	1-phase L-N
Instantaneous	x 1.00	x 0.87	x 1.30
Minimum	x 1.00	x 1.80	x 3.20
Sustained	x 1.00	x 1.50	x 2.50
Max. sustained duration	10 sec.	5 sec.	2 sec.

All other times are unchanged

Note 3

Curves are drawn for Star (Wye) connected machines. For other connection the following multipliers should be applied to current values as shown :

Parallel Star = Curve current value X 2

Series Delta = Curve current value X 1.732

UCI274C
Winding 311 / 0.8 Power Factor

RATINGS

Class - Temp Rise	Cont. F - 105/40°C				Cont. H - 125/40°C				Standby - 150/40°C				Standby - 163/27°C				
50 Hz	Series Star (V)	380	400	415	440	380	400	415	440	380	400	415	440	380	400	415	440
	Parallel Star (V)	190	200	208	220	190	200	208	220	190	200	208	220	190	200	208	220
	Series Delta (V)	220	230	240	254	220	230	240	254	220	230	240	254	220	230	240	254
	kVA	84.0	84.0	84.0	N/A	100.0	100.0	100.0	N/A	106.0	106.0	106.0	N/A	110.0	110.0	110.0	N/A
	kW	67.2	67.2	67.2	N/A	80.0	80.0	80.0	N/A	84.8	84.8	84.8	N/A	88.0	88.0	88.0	N/A
	Efficiency (%)	90.7	91.1	91.3	N/A	89.8	90.3	90.6	N/A	89.5	90.0	90.4	N/A	89.2	89.8	90.2	N/A
	kW Input	74.1	73.8	73.6	N/A	89.1	88.6	88.3	N/A	94.7	94.2	93.8	N/A	98.7	98.0	97.6	N/A

60 Hz	Series Star (V)	416	440	460	480	416	440	460	480	416	440	460	480	416	440	460	480
	Parallel Star (V)	208	220	230	240	208	220	230	240	208	220	230	240	208	220	230	240
	Series Delta (V)	240	254	266	277	240	254	266	277	240	254	266	277	240	254	266	277
	kVA	97.5	106.3	106.3	112.5	112.5	117.5	117.5	125.0	116.3	125.0	125.0	132.5	120.0	127.5	127.5	137.5
	kW	78.0	85.0	85.0	90.0	90.0	94.0	94.0	100.0	93.0	100.0	100.0	106.0	96.0	102.0	102.0	110.0
	Efficiency (%)	90.9	91.0	91.4	91.5	90.2	90.6	91.0	91.1	90.0	90.2	90.7	90.8	89.8	90.1	90.6	90.6
	kW Input	85.8	93.5	93.0	98.4	99.8	103.8	103.3	109.8	103.4	110.9	110.3	116.7	106.9	113.2	112.6	121.4

DIMENSIONS

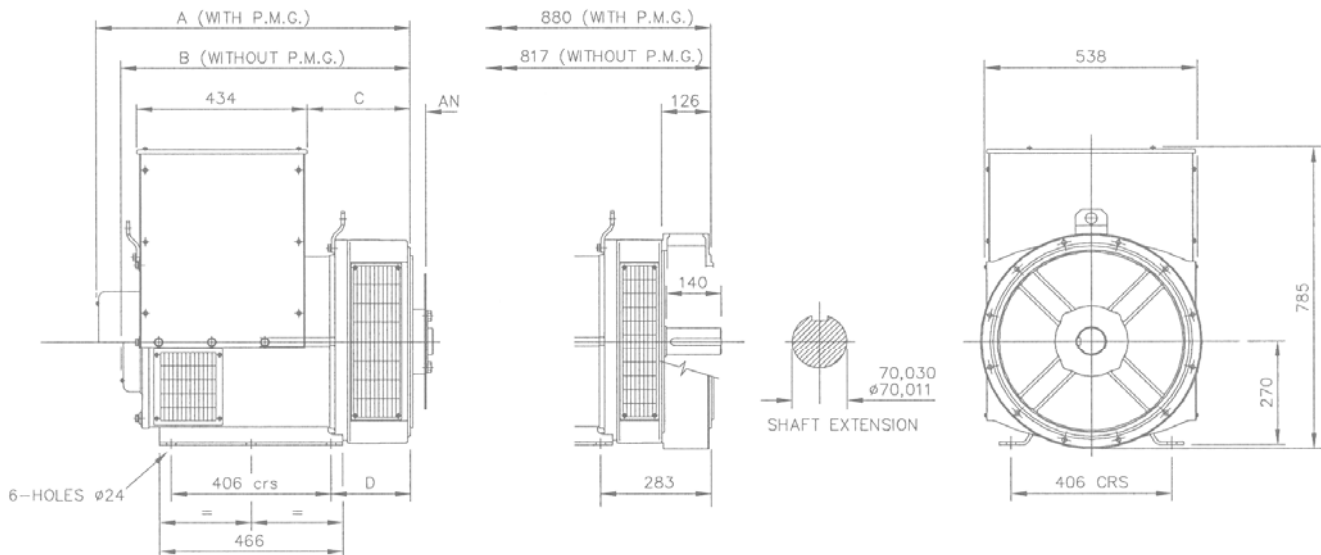

SINGLE BEARING ADAPTORS				
ADAPTOR	A	B	C	D
SAE 1	813,3	750,3	274,3	216,3
SAE 2	799	736	260	202
SAE 3	799	736	260	202

COUPLING DISCS	
DISC	AN
SAE 10	53,98
SAE 11,5	39,68
SAE 14	25,40

6BTAA5.9-G3

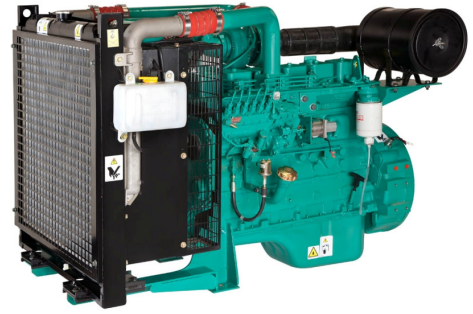

> Specification sheet

Our energy working for you.™



Description

The B5.9 engine has established an unrivalled reputation for reliability, incorporating features designed to maximise engine integration within OEM installation. The 6BTAA5.9-G3 CoolPac is assembled in our new facility at Pirangut, India and utilises the latest Cummins manufacturing processes and Quality Standards.



This engine has been built to comply with CE certification.



This engine has been designed in facilities certified to ISO9001 and manufactured in facilities certified to ISO9001 or ISO 9002 or TS16949.

Features

Single Poly Vee belt drive for fan, alternator and water pump, with self-tensioning idler for minimum maintenance.

Inline-type Bosch VE-Series pump operates at high injection pressures for cleaner combustion and lower emissions.

Spin-on fuel filter and full-flow lubricating oil filter.

Top mounted Holset HX35 turbocharger for increased power, fuel economy, and lower smoke and noise levels.

Coolpac Integrated Design - Products are supplied complete with cooling package and air cleaner kit for a complete power package. Each component has been specifically developed and rigorously tested for G-Drive products, ensuring high performance, durability and reliability.

Service and Support - G-Drive products are backed by an uncompromising level of technical support and after sales service, delivered through a world class service network.

1500 rpm (50 Hz Ratings)

Gross Engine Output			Net Engine Output			Typical Generator Set Output					
Standby	Prime	Base	Standby	Prime	Base	Standby (ESP)		Prime (PRP)		Base (COP)	
kWm/BHP			kWm/BHP			kWe	kVA	kWe	kVA	kWe	kVA
127/170	116/155	87/116	117/157	107/143	78/105	110	138	100	125	70	88



General Engine Data

Type	4 cycle, in-line, Turbo Charged
Bore mm	102 mm (4.02 in.)
Stroke mm	120 mm (4.72 in.)
Displacement Litre	5.9 litre (360.0 in. ³)
Cylinder Block	Cast iron, 6 cylinder
Battery Charging Alternator	55 amps
Starting Voltage	12 volt, 55 Amp negative ground
Fuel System	Direct injection
Fuel Filter	Spin-on fuel filters with water separator
Lube Oil Filter Type(s)	Spin-on full flow filter
Lube Oil Capacity (l)	16.4
Flywheel Dimensions	3/11.5

Coolpac Performance Data

Cooling System Design	Jacket Water and Charge Air After Cooled
Coolant Ratio	50% ethylene glycol; 50% water
Coolant Capacity (l)	26
Limiting Ambient Temp.**	50DegC
Fan Power(hp)	8
Cooling System Air Flow (m ³ /s)**	3.40
Air Cleaner Type (Medium Duty)	Dry replaceable element with restriction indicator

** @ 13 mm H₂O at 100% Prime

Ratings Definitions

Emergency Standby Power (ESP):

Applicable for supplying power to varying electrical load for the duration of power interruption of a reliable utility source. Emergency Standby Power (ESP) is in accordance with ISO 3046, AS 2789, DIN 6271 and BS 5514.

Limited-Time Running Power (LTP):

Applicable for supplying power to a constant electrical load for limited hours. Limited-Time Running Power (LTP) is in accordance with ISO 8528.

Prime Power (PRP):

Applicable for supplying power to varying electrical load for unlimited hours. Prime Power (PRP) is in accordance with ISO 8528. Ten percent overload capability is available in accordance with ISO 3046, AS 2789, DIN 6271 and BS 5514.

Base Load (Continuous) Power (COP):

Applicable for supplying power continuously to a constant electrical load for unlimited hours. Continuous Power (COP) in accordance with ISO 8528, ISO 3046, AS 2789, DIN6271 and BS 5514.

Shipping Weight & Dimensions

	Length	Width	Height	Weight (dry)
	mm	mm	mm	kg
CoolPac	1862	1162	1551	525

Fuel Consumption 1500 (50 Hz)

%	kWm	BHP	L/ph	US gal/ph
Standby Power				
100	127	170	33	8.6
Prime Power				
100	116	155	29	7.7
75	87	116	21	5.6
50	58	78	14	3.7
25	29	39	8	2
Continuous Power				
100	87	116	21	5.6

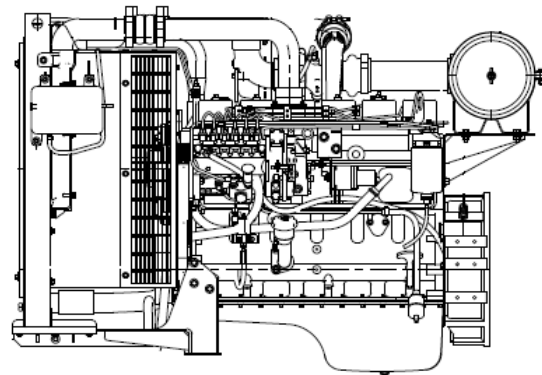

Cummins G Drive Engines

Asia Pacific

10 Toh Guan Road
#07-01
TT International Tradepark
Singapore 608838
Phone 65 6417 2388
Fax 65 6417 2399

Europe, CIS, Middle East and Africa

Manston Park Columbus Ave
Manston Ramsgate
Kent CT12 5BF, UK
Phone 44 1843 255000
Fax 44 1843 255902

Latin America

Rua Jati, 310, Cumbica
Guarulhos, SP 07180-900
Brazil
Phone 55 11 2186 4552
Fax 55 11 2186 4729

6BTAA5.9-G6



> Specification sheet



Our energy working for you.™

Description

The B5.9 engine has established an unrivalled reputation for reliability, incorporating features designed to maximise engine integration within OEM installation. The 6BTAA5.9-G6 CoolPac utilises the latest Cummins manufacturing processes and Quality Standards.



This engine has been built to comply with CE certification.



This engine has been designed in facilities certified to ISO9001 and manufactured in facilities certified to ISO9001 or ISO 9002 or TS16949.

Features

Single Poly Vee belt drive for fan, alternator and water pump, with self-tensioning idler for minimum maintenance.

Rotary-type Bosch pump operates at high injection pressures for cleaner combustion and lower emissions.

Spin-on fuel filter and full-flow lubricating oil filter.

Top mounted Holset HX35 turbocharger for increased power, fuel economy, and lower smoke and noise levels.

CoolPac Integrated Design - Products are supplied complete with cooling package and air cleaner kit for a complete power package. Each component has been specifically developed and rigorously tested for G-Drive products, ensuring high performance, durability and reliability.

Service and Support - G-Drive products are backed by an uncompromising level of technical support and after sales service delivered through a world class service network.

1500 rpm (50 Hz Ratings)

Gross Engine Output			Typical Generator Set Output			
Standby	Prime	Base	Standby (ESP)		Prime (PRP)	
kWm/BHP			kWe	kVA	kWe	kVA
145/195	135/180	135/180	120	150	109	136

1800 rpm (60 Hz Ratings)

Gross Engine Output			Typical Generator Set Output			
Standby	Prime	Base	Standby (ESP)		Prime (PRP)	
kWm/BHP			kWe	kVA	kWe	kVA
160/215	150/205	145/195	135	169	123	153



General Engine Data

Type	4- cycle, In-line, 6- cylinder, Turbocharged and Charge Air Cooled, Diesel
Bore mm	102 mm (4.02 in.)
Stroke mm	120 mm (4.72 in.)
Displacement Litre	5.9 litre (360.0 in. ³)
Cylinder Block	Cast iron, 6 cylinder
Battery Charging Alternator	55 amps
Starting Voltage	12 volt, 55 Amp negative ground
Fuel System	Direct injection
Fuel Filter	Venturi Combo Stratapore Filter
Lube Oil Filter Type(s)	Venturi Combo Stratapore Filter
Lube Oil Capacity (l)	16.4
Flywheel Dimensions	SAE3/11.5

Coolpac Performance Data

Cooling System Design	Charged Air Cooled
Coolant Ratio	50% ethylene glycol; 50% water
Total Coolant Capacity (l)	21.4
Limiting Ambient Temp**	50 Degrees
Fan Power (kWm)	10
Cooling System Air Flow (m ³ /s)**	3.7 for 60Hz & 2.7 for 50Hz
Air Cleaner Type (heavy duty)	Dry replaceable element with restriction indicator

** @ 13 mm H₂O

Weight and Dimensions

	Length	Width	Height	Weight (dry)
	mm	mm	mm	kg
CoolPac	1723	896	1380	718

Ratings Definitions

Emergency Standby Power (ESP):

Applicable for supplying power to varying electrical load for the duration of power interruption of a reliable utility source. Emergency Standby Power (ESP) is in accordance with ISO 3046, AS 2789, DIN 6271 and BS 5514.

Limited-Time Running Power (LTP):

Applicable for supplying power to a constant electrical load for limited hours. Limited-Time Running Power (LTP) is in accordance with ISO 8528.

Prime Power (PRP):

Applicable for supplying power to varying electrical load for unlimited hours. Prime Power (PRP) is in accordance with ISO 8528. Ten percent overload capability is available in accordance with ISO 3046, AS 2789, DIN 6271 and BS 5514.

Base Load (Continuous) Power (COP):

Applicable for supplying power continuously to a constant electrical load for unlimited hours. Continuous Power (COP) in accordance with ISO 8528, ISO 3046, AS 2789, DIN6271 and BS 5514.

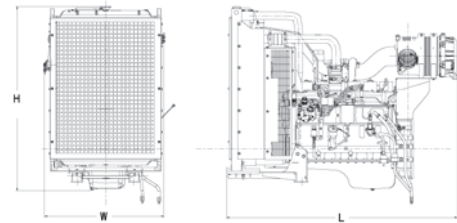

Fuel Consumption 1500 (50 Hz)

%	kWm	BHP	L/ph	US gal/ph
Standby Power				
100	145	195	37.05	9.89
Prime Power				
100	135	180	35.16	9.46
75	101	165	26.58	7.14
50	68	91	17.92	4.80
25	34	46	9.43	2.50
Continuous Power				
100	135	180	35.16	9.46

Fuel Consumption 1800 (60 Hz)

%	kWm	BHP	L/ph	US gal/ph
Standby Power				
100	160	215	41.14	10.86
Prime Power				
100	150	205	36.46	10.42
75	113	152	31.47	8.31
50	75	101	20.71	5.46
25	38	51	11.71	3.09
Continuous Power				
100	145	195	36.59	9.66

Cummins G-Drive Engines

Asia Pacific

10 Toh Guan Road
#07-01
TT International Tradepark
Singapore 608838
Phone 65 6417 2388
Fax 65 6417 2399

Europe, CIS, Middle

East and Africa
Manston Park Columbus Ave
Manston Ramsgate
Kent CT12 5BF, UK
Phone 44 1843 255000
Fax 44 1843 255902

Latin America

Rua Jati, 310, Cumbica
Guarulhos, SP 07180-900
Brazil
Phone 55 11 2186 4552
Fax 55 11 2186 4729

Mexico

Cummins S. de R.L. de C.V.
Eje 122 No. 200 Zona Industrial
San Luis Potosi, S.L.P. 78090
Mexico
Phone 52 444 870 6700
Fax 52 444 870 6811

North America

1400 73rd Avenue N.E.
Minneapolis, MN 55432
USA
Phone 1 763 574 5000
USA Toll-free 1 877 769 7669
Fax 1 763 574 5298



STAMFORD[®]

UCI274E - Technical Data Sheet

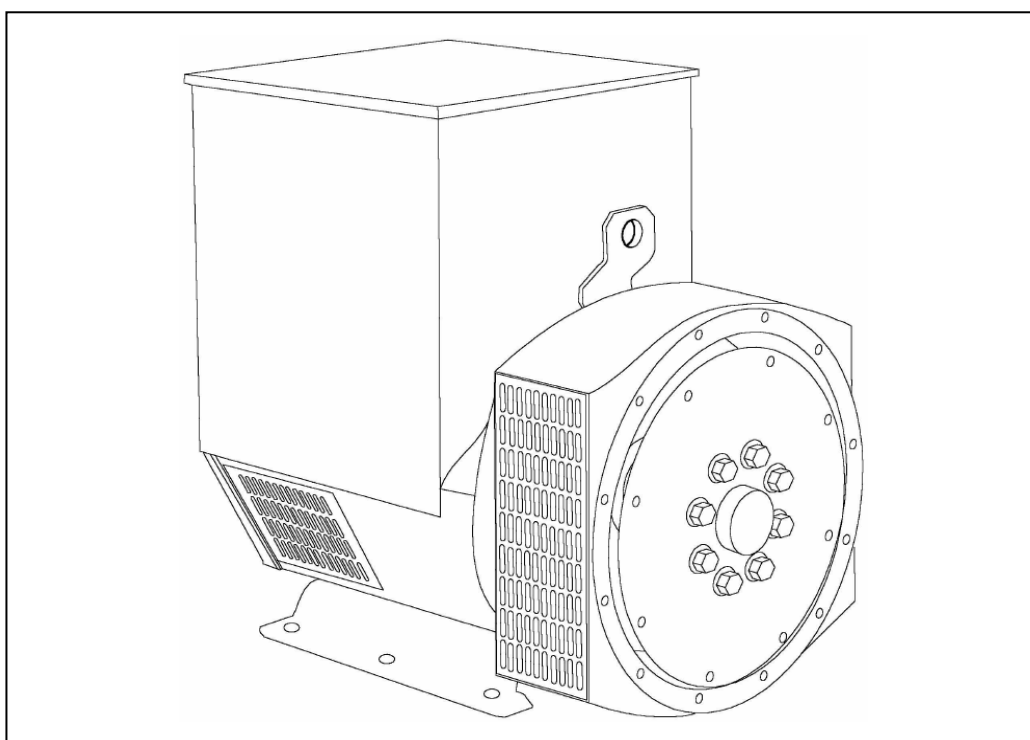

UCI274E

SPECIFICATIONS & OPTIONS

STAMFORD

STANDARDS

Newage Stamford industrial generators meet the requirements of BS EN 60034 and the relevant section of other international standards such as BS5000, VDE 0530, NEMA MG1-32, IEC34, CSA C22.2-100, AS1359. Other standards and certifications can be considered on request.

VOLTAGE REGULATORS

SX460 AVR - STANDARD

With this self excited control system the main stator supplies power via the Automatic Voltage Regulator (AVR) to the exciter stator. The high efficiency semiconductors of the AVR ensure positive build-up from initial low levels of residual voltage.

The exciter rotor output is fed to the main rotor through a three phase full wave bridge rectifier. This rectifier is protected by a surge suppressor against surges caused, for example, by short circuit.

AS440 AVR

With this self-excited system the main stator provides power via the AVR to the exciter stator. The high efficiency semi-conductors of the AVR ensure positive build-up from initial low levels of residual voltage.

The exciter rotor output is fed to the main rotor through a three-phase full-wave bridge rectifier. The rectifier is protected by a surge suppressor against surges caused, for example, by short circuit or out-of-phase paralleling.

The AS440 will support a range of electronic accessories, including a 'droop' Current Transformer (CT) to permit parallel operation with other ac generators.

MX341 AVR

This sophisticated AVR is incorporated into the Stamford Permanent Magnet Generator (PMG) control system.

The PMG provides power via the AVR to the main exciter, giving a source of constant excitation power independent of generator output. The main exciter output is then fed to the main rotor, through a full wave bridge, protected by a surge suppressor. The AVR has in-built protection against sustained over-excitation, caused by internal or external faults. This de-excites the machine after a minimum of 5 seconds.

An engine relief load acceptance feature can enable full load to be applied to the generator in a single step.

If three-phase sensing is required with the PMG system the MX321 AVR must be used.

We recommend three-phase sensing for applications with greatly unbalanced or highly non-linear loads.

MX321 AVR

The most sophisticated of all our AVRs combines all the features of the MX341 with, additionally, three-phase rms sensing, for improved regulation and performance.

Over voltage protection is built-in and short circuit current level adjustments is an optional facility.

WINDINGS & ELECTRICAL PERFORMANCE

All generator stators are wound to 2/3 pitch. This eliminates triplen (3rd, 9th, 15th ...) harmonics on the voltage waveform and is found to be the optimum design for trouble-free supply of non-linear loads. The 2/3 pitch design avoids excessive neutral currents sometimes seen with higher winding pitches, when in parallel with the mains. A fully connected damper winding reduces oscillations during paralleling. This winding, with the 2/3 pitch and carefully selected pole and tooth designs, ensures very low waveform distortion.

TERMINALS & TERMINAL BOX

Standard generators are 3-phase reconnectable with 12 ends brought out to the terminals, which are mounted on a cover at the non-drive end of the generator. A sheet steel terminal box contains the AVR and provides ample space for the customers' wiring and gland arrangements. It has removable panels for easy access.

SHAFT & KEYS

All generator rotors are dynamically balanced to better than BS6861:Part 1 Grade 2.5 for minimum vibration in operation. Two bearing generators are balanced with a half key.

INSULATION/IMPREGNATION

The insulation system is class 'H'.

All wound components are impregnated with materials and processes designed specifically to provide the high build required for static windings and the high mechanical strength required for rotating components.

QUALITY ASSURANCE

Generators are manufactured using production procedures having a quality assurance level to BS EN ISO 9001.

The stated voltage regulation may not be maintained in the presence of certain radio transmitted signals. Any change in performance will fall within the limits of Criteria 'B' of EN 61000-6-2:2001. At no time will the steady-state voltage regulation exceed 2%.

NB Continuous development of our products entitles us to change specification details without notice, therefore they must not be regarded as binding.

Front cover drawing typical of product range.

UCI274E

STAMFORD

WINDING 311

CONTROL SYSTEM	SEPARATELY EXCITED BY P.M.G.							
A.V.R.	MX321	MX341						
VOLTAGE REGULATION	± 0.5 %	± 1.0 %	With 4% ENGINE GOVERNING					
SUSTAINED SHORT CIRCUIT	REFER TO SHORT CIRCUIT DECREMENT CURVES (page 7)							
CONTROL SYSTEM	SELF EXCITED							
A.V.R.	SX460	AS440						
VOLTAGE REGULATION	± 1.0 %	± 1.0 %	With 4% ENGINE GOVERNING					
SUSTAINED SHORT CIRCUIT	SERIES 4 CONTROL DOES NOT SUSTAIN A SHORT CIRCUIT CURRENT							
INSULATION SYSTEM	CLASS H							
PROTECTION	IP23							
RATED POWER FACTOR	0.8							
STATOR WINDING	DOUBLE LAYER CONCENTRIC							
WINDING PITCH	TWO THIRDS							
WINDING LEADS	12							
STATOR WDG. RESISTANCE	0.0317 Ohms PER PHASE AT 22°C SERIES STAR CONNECTED							
ROTOR WDG. RESISTANCE	1.34 Ohms at 22°C							
EXCITER STATOR RESISTANCE	20 Ohms at 22°C							
EXCITER ROTOR RESISTANCE	0.091 Ohms PER PHASE AT 22°C							
R.F.I. SUPPRESSION	BS EN 61000-6-2 & BS EN 61000-6-4, VDE 0875G, VDE 0875N. refer to factory for others							
WAVEFORM DISTORTION	NO LOAD < 1.5% NON-DISTORTING BALANCED LINEAR LOAD < 5.0%							
MAXIMUM OVERSPEED	2250 Rev/Min							
BEARING DRIVE END	BALL. 6315-2RS (ISO)							
BEARING NON-DRIVE END	BALL. 6310-2RS (ISO)							
	1 BEARING				2 BEARING			
WEIGHT COMP. GENERATOR	492 kg				511 kg			
WEIGHT WOUND STATOR	180 kg				180 kg			
WEIGHT WOUND ROTOR	167.51 kg				156.55 kg			
WR ² INERTIA	1.3271 kgm ²				1.2765 kgm ²			
SHIPPING WEIGHTS in a crate	525 kg				539 kg			
PACKING CRATE SIZE	123 x 67 x 103(cm)				123 x 67 x 103(cm)			
	50 Hz				60 Hz			
TELEPHONE INTERFERENCE	THF<2%				TIF<50			
COOLING AIR	0.514 m ³ /sec 1090 cfm				0.617 m ³ /sec 1308 cfm			
VOLTAGE SERIES STAR	380/220	400/231	415/240	440/254	416/240	440/254	460/266	480/277
VOLTAGE PARALLEL STAR	190/110	200/115	208/120	220/127	208/120	220/127	230/133	240/138
VOLTAGE SERIES DELTA	220/110	230/115	240/120	254/127	240/120	254/127	266/133	277/138
KVA BASE RATING FOR REACTANCE VALUES	140	140	140	N/A	160	167.5	167.5	178.8
X _d DIR. AXIS SYNCHRONOUS	2.34	2.11	1.96	-	2.68	2.51	2.29	2.25
X' _d DIR. AXIS TRANSIENT	0.21	0.19	0.18	-	0.25	0.23	0.21	0.21
X'' _d DIR. AXIS SUBTRANSIENT	0.14	0.13	0.12	-	0.17	0.16	0.15	0.14
X _q QUAD. AXIS REACTANCE	1.53	1.38	1.28	-	1.74	1.63	1.49	1.46
X'' _q QUAD. AXIS SUBTRANSIENT	0.18	0.16	0.15	-	0.22	0.21	0.19	0.18
X _L LEAKAGE REACTANCE	0.08	0.08	0.07	-	0.09	0.08	0.08	0.08
X ₂ NEGATIVE SEQUENCE	0.16	0.14	0.13	-	0.19	0.18	0.16	0.16
X ₀ ZERO SEQUENCE	0.10	0.09	0.08	-	0.11	0.10	0.09	0.09
REACTANCES ARE SATURATED		VALUES ARE PER UNIT AT RATING AND VOLTAGE INDICATED						
T' _d TRANSIENT TIME CONST.	0.032 s							
T'' _d SUB-TRANSTIME CONST.	0.01 s							
T' _{do} O.C. FIELD TIME CONST.	0.85 s							
T _a ARMATURE TIME CONST.	0.007 s							
SHORT CIRCUIT RATIO	1/X _d							

50
Hz

UCI274E
Winding 311

STAMFORD

THREE PHASE EFFICIENCY CURVES

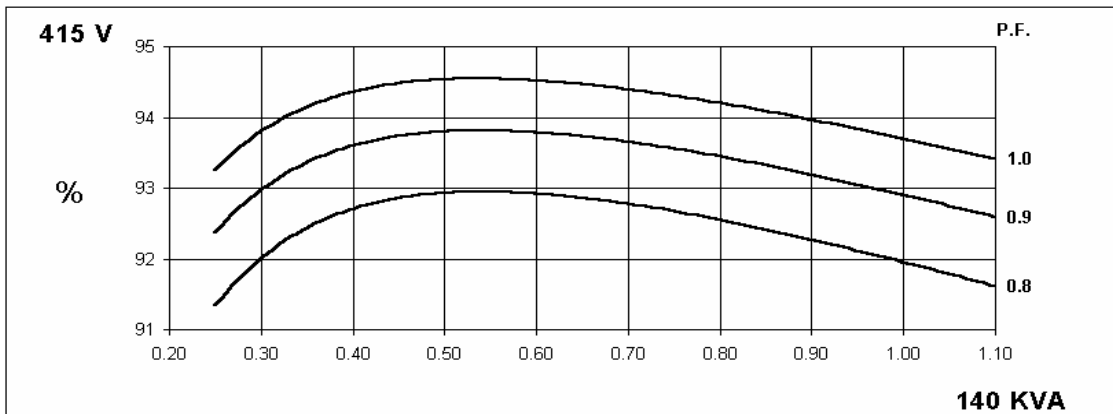
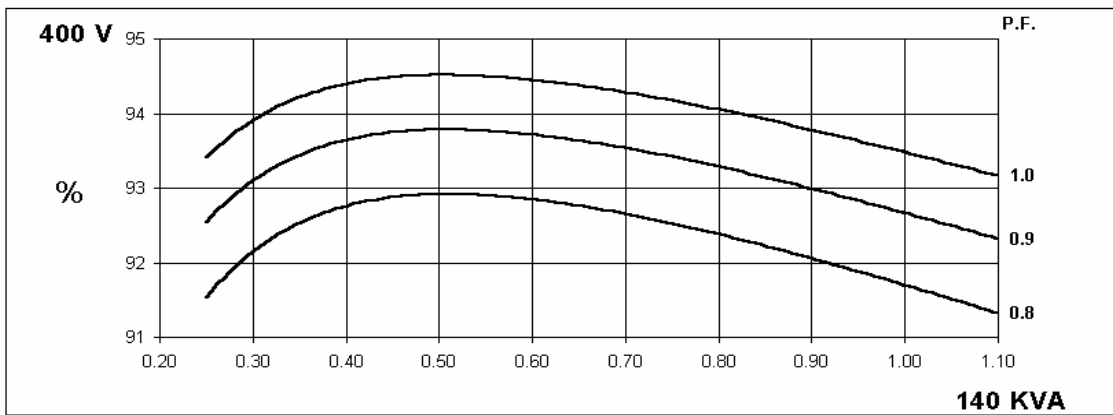
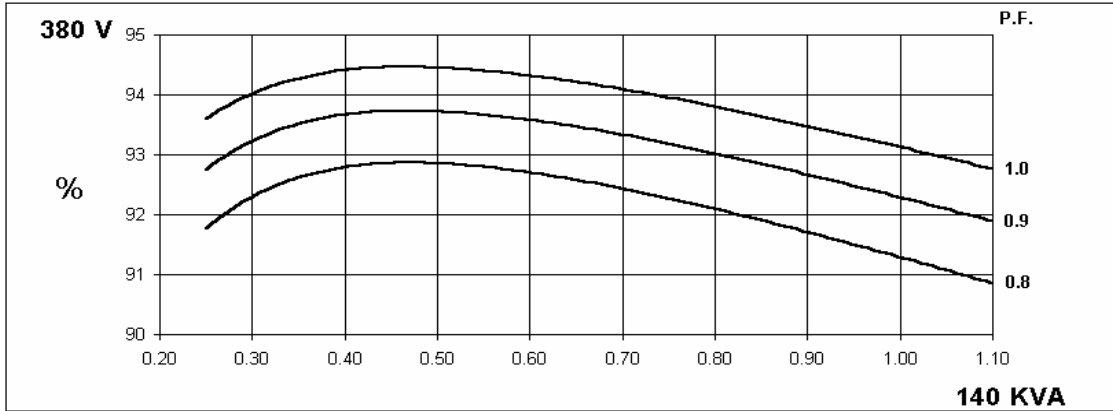

60
Hz

UCI274E
Winding 311

STAMFORD

THREE PHASE EFFICIENCY CURVES

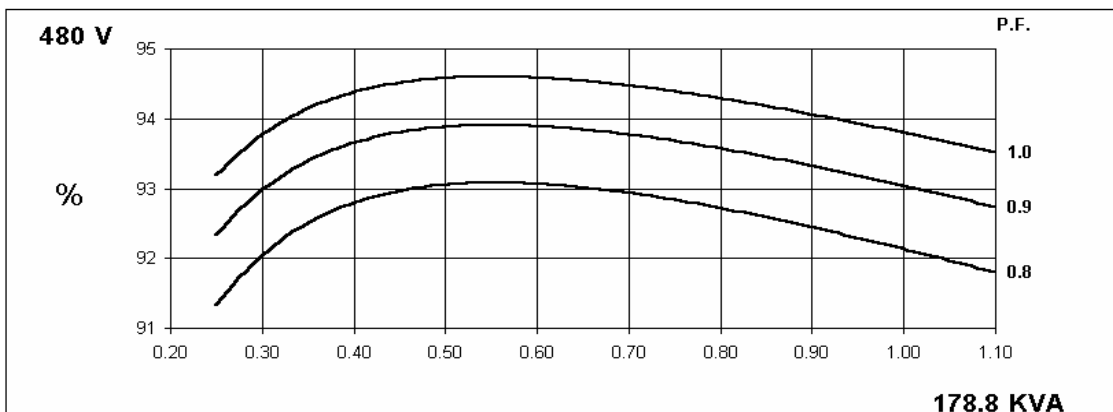
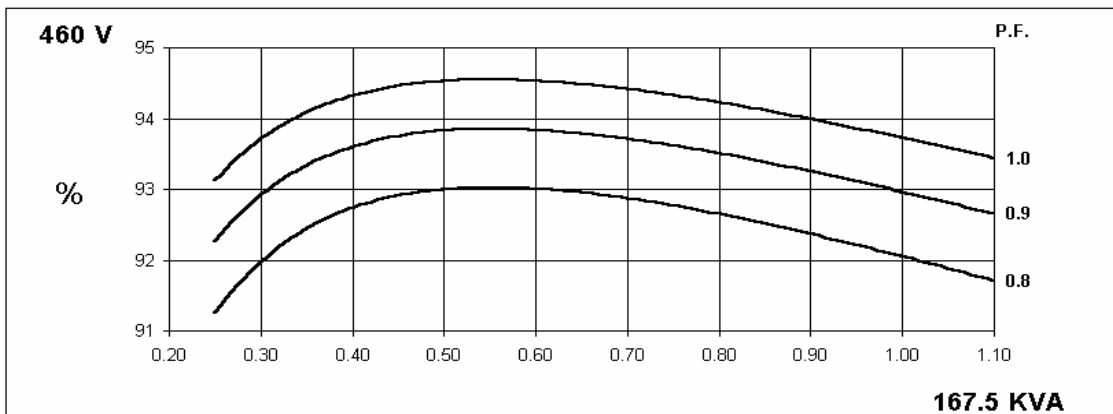
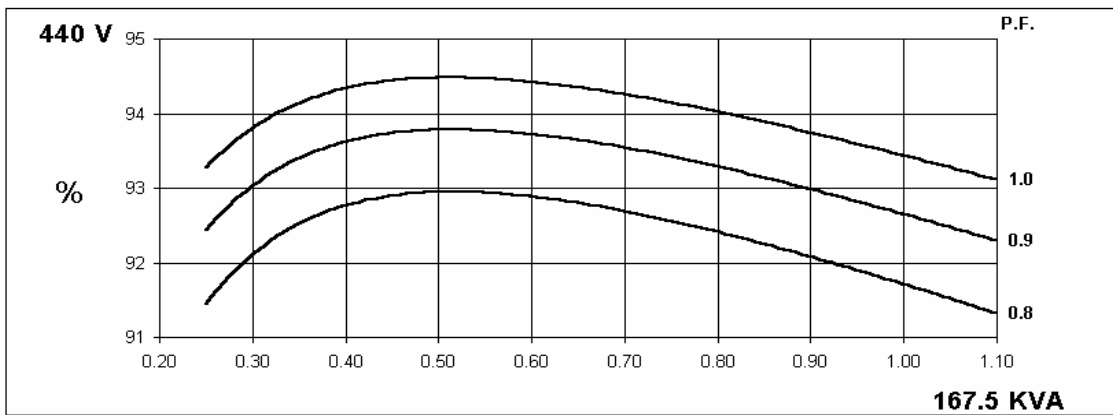
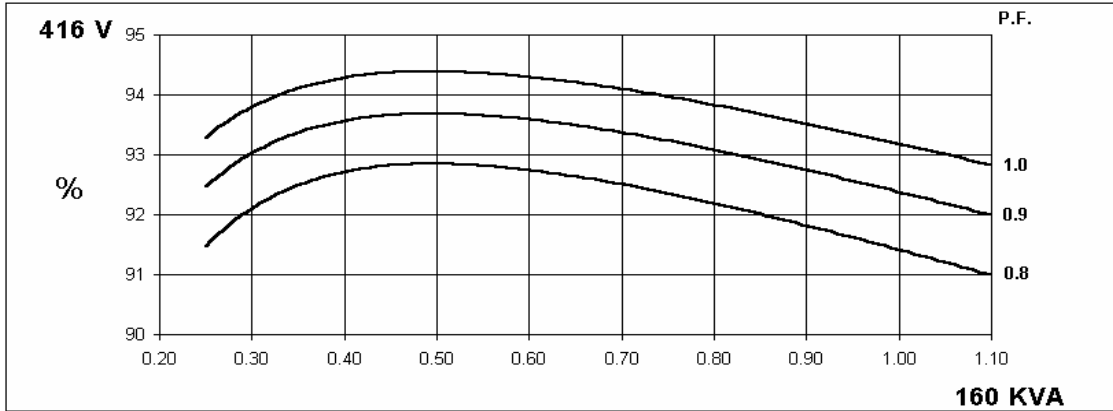

Locked Rotor Motor Starting Curve

50
Hz

MX

SX

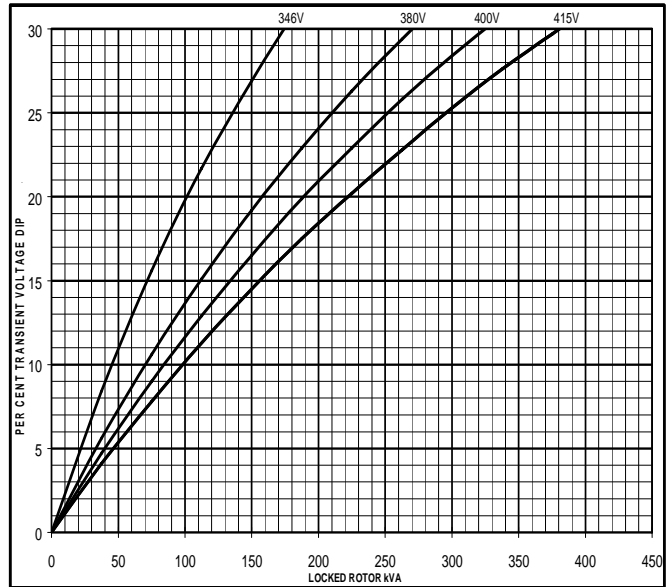
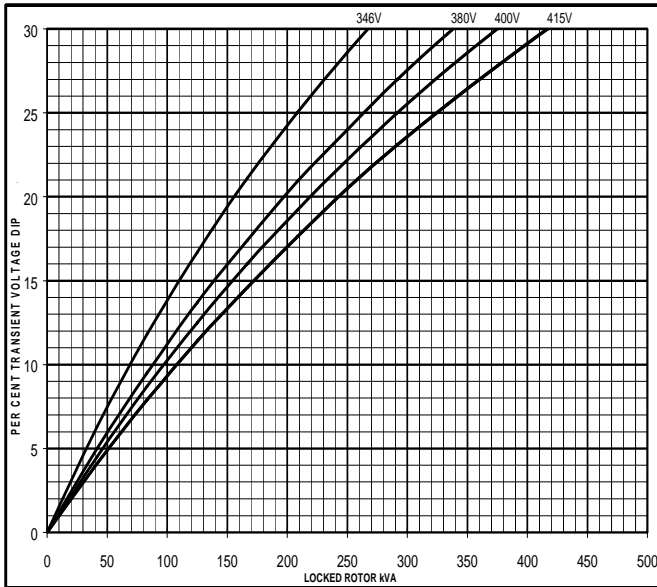

60
Hz

MX

SX

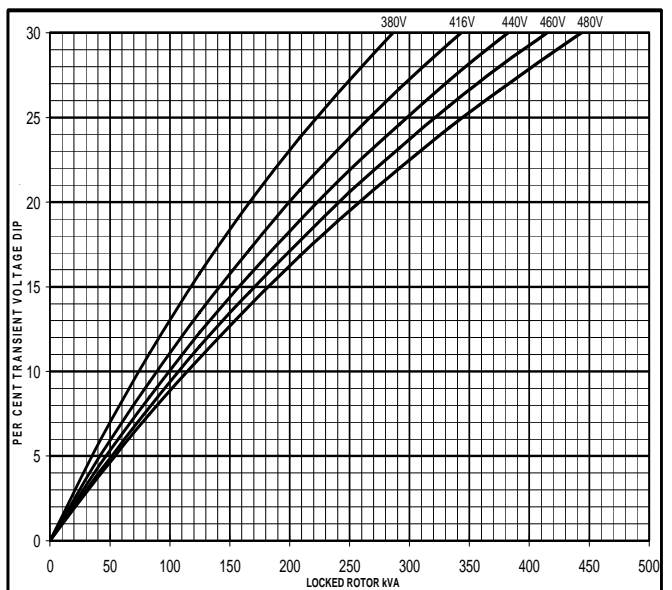
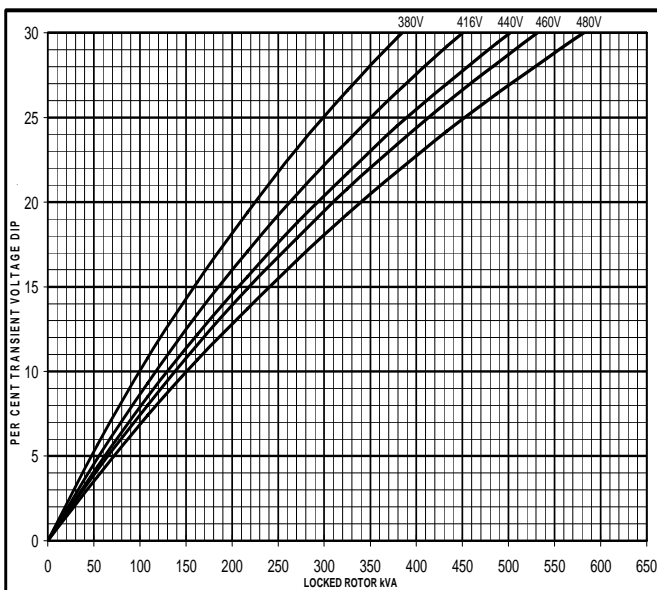

**Three-phase Short Circuit Decrement Curve. No-load Excitation at Rated Speed
Based on star (wye) connection.**

**50
Hz**

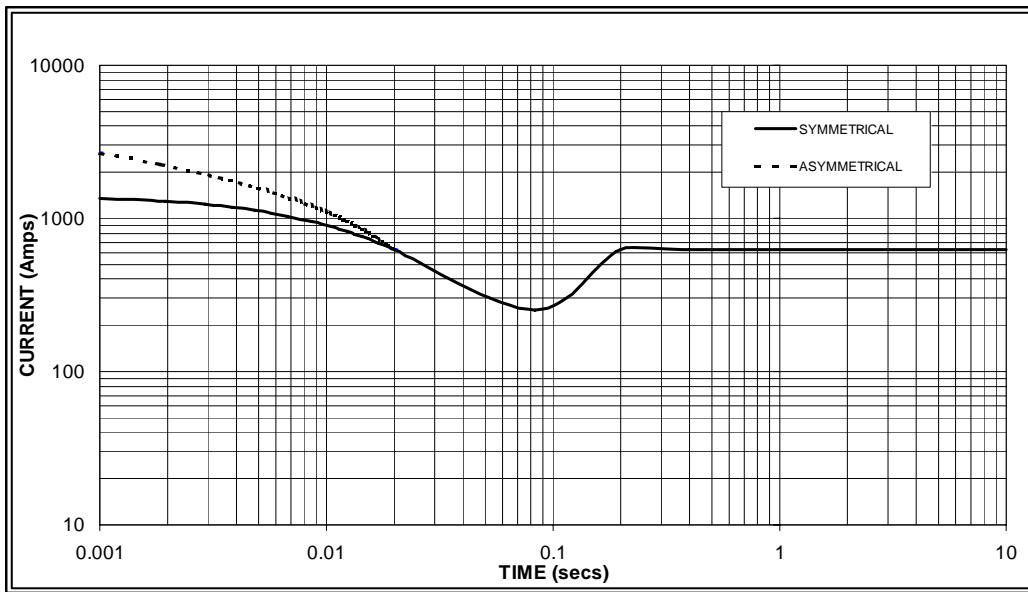

Sustained Short Circuit = 630 Amps

**60
Hz**

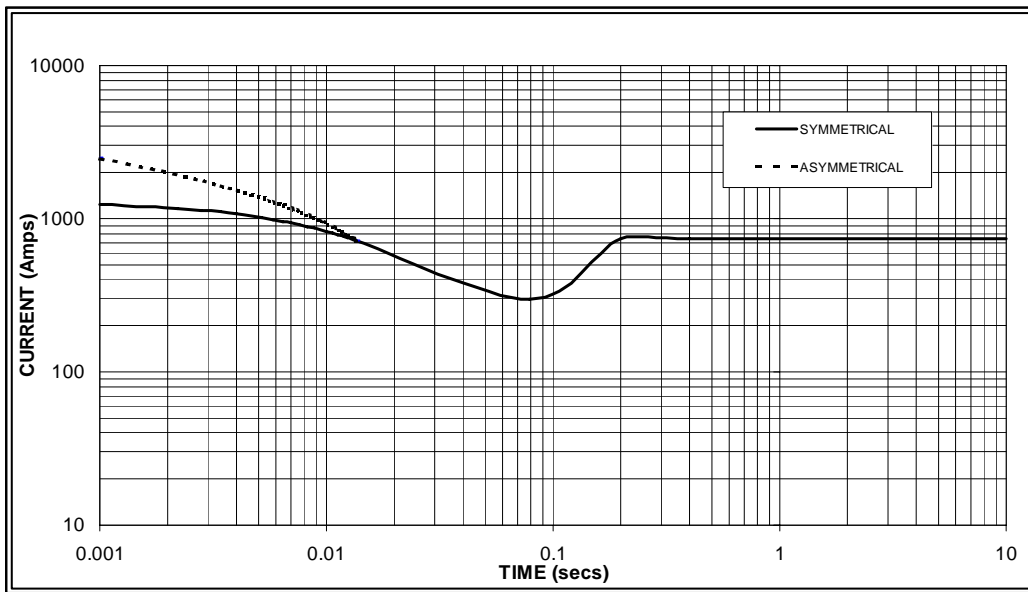

Sustained Short Circuit = 740 Amps

Note 1

The following multiplication factors should be used to adjust the values from curve between time 0.001 seconds and the minimum current point in respect of nominal operating voltage :

50Hz		60Hz	
Voltage	Factor	Voltage	Factor
380v	X 1.00	416v	X 1.00
400v	X 1.07	440v	X 1.06
415v	X 1.12	460v	X 1.12
		480v	X 1.17

The sustained current value is constant irrespective of voltage level

Note 2

The following multiplication factor should be used to convert the values calculated in accordance with NOTE 1 to those applicable to the various types of short circuit :

	3-phase	2-phase L-L	1-phase L-N
Instantaneous	x 1.00	x 0.87	x 1.30
Minimum	x 1.00	x 1.80	x 3.20
Sustained	x 1.00	x 1.50	x 2.50
Max. sustained duration	10 sec.	5 sec.	2 sec.

All other times are unchanged

Note 3

Curves are drawn for Star (Wye) connected machines. For other connection the following multipliers should be applied to current values as shown :

Parallel Star = Curve current value X 2

Series Delta = Curve current value X 1.732

UCI274E

STAMFORD

Winding 311 / 0.8 Power Factor

RATINGS

Class - Temp Rise	Cont. F - 105/40°C				Cont. H - 125/40°C				Standby - 150/40°C				Standby - 163/27°C				
50 Hz	Series Star (V)	380	400	415	440	380	400	415	440	380	400	415	440	380	400	415	440
	Parallel Star (V)	190	200	208	220	190	200	208	220	190	200	208	220	190	200	208	220
	Series Delta (V)	220	230	240	254	220	230	240	254	220	230	240	254	220	230	240	254
kVA	125.0	125.0	125.0	N/A	140.0	140.0	140.0	N/A	145.0	145.0	145.0	N/A	150.0	150.0	150.0	N/A	
kW	100.0	100.0	100.0	N/A	112.0	112.0	112.0	N/A	116.0	116.0	116.0	N/A	120.0	120.0	120.0	N/A	
Efficiency (%)	91.7	92.1	92.3	N/A	91.3	91.7	92.0	N/A	91.1	91.6	91.8	N/A	91.0	91.4	91.7	N/A	
kW Input	109.1	108.6	108.3	N/A	122.7	122.1	121.7	N/A	127.3	126.6	126.4	N/A	131.9	131.3	130.9	N/A	

60 Hz	Series Star (V)	416	440	460	480	416	440	460	480	416	440	460	480	416	440	460	480
	Parallel Star (V)	208	220	230	240	208	220	230	240	208	220	230	240	208	220	230	240
	Series Delta (V)	240	254	266	277	240	254	266	277	240	254	266	277	240	254	266	277
kVA	140.0	143.8	143.8	160.0	160.0	167.5	167.5	178.8	170.0	175.0	175.0	187.5	175.0	181.3	181.3	193.8	
kW	112.0	115.0	115.0	128.0	128.0	134.0	134.0	143.0	136.0	140.0	140.0	150.0	140.0	145.0	145.0	155.0	
Efficiency (%)	91.9	92.2	92.5	92.5	91.4	91.7	92.1	92.1	91.2	91.5	91.9	92.0	91.0	91.4	91.8	91.9	
kW Input	121.9	124.8	124.4	138.4	140.0	146.1	145.5	155.3	149.1	153.0	152.3	163.0	153.8	158.7	158.0	168.7	

DIMENSIONS

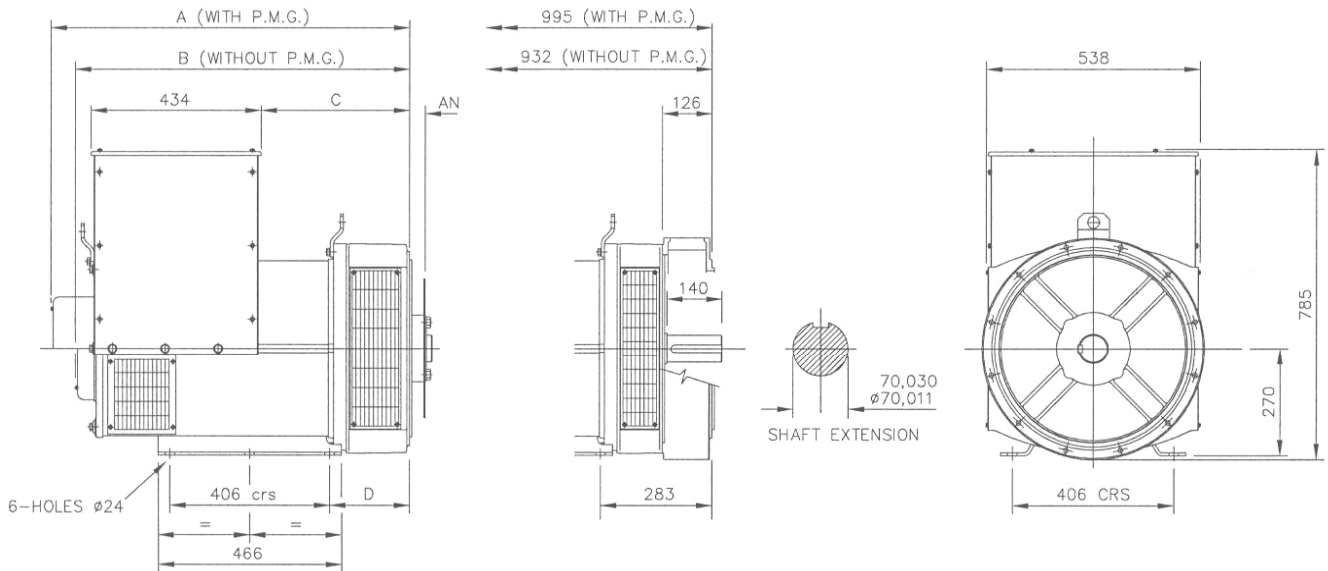

SINGLE BEARING ADAPTORS				
ADAPTOR	A	B	C	D
SAE 1	928,3	865,3	389,3	216,3
SAE 2	914	851	375	202
SAE 3	914	851	375	202

COUPLING DISCS	
DISC	AN
SAE 10	53,98
SAE 11,5	39,68
SAE 14	25,40

STAMFORD

Barnack Road • Stamford • Lincolnshire • PE9 2NB

Tel: 00 44 (0)1780 484000 • Fax: 00 44 (0)1780 484100

6BTAA5.9-G7



> Specification sheet



Our energy working for you.™

Description

The B5.9 engine has established an unrivalled reputation for reliability, incorporating features designed to maximise engine integration within OEM installation. The 6BTAA5.9-G7 CoolPac utilises the latest Cummins manufacturing processes and Quality Standards.



This engine has been built to comply with CE certification.



This engine has been designed in facilities certified to ISO9001 and manufactured in facilities certified to ISO9001 or ISO 9002 or TS16949.

Features

Single Poly Vee belt drive for fan, alternator and water pump, with self-tensioning idler for minimum maintenance.

Rotary-type Bosch pump operates at high injection pressures for cleaner combustion and lower emissions.

Spin-on fuel filter and full-flow lubricating oil filter.

Top mounted Holset HX35 turbocharger for increased power, fuel economy, and lower smoke and noise levels.

CoolPac Integrated Design - Products are supplied complete with cooling package and air cleaner kit for a complete power package. Each component has been specifically developed and rigorously tested for G-Drive products, ensuring high performance, durability and reliability.

Service and Support - G-Drive products are backed by an uncompromising level of technical support and after sales service delivered through a world class service network.

1500 rpm (50 Hz Ratings)

Gross Engine Output			Typical Generator Set Output			
Standby	Prime	Base	Standby (ESP)		Prime (PRP)	
kWm/BHP			kWe	kVA	kWe	kVA
160/215	145/195	101/135	136	170	124	155



General Engine Data

Type	4- cycle, In-line, 6- cylinder, Turbocharged and Charge Air Cooled, Diesel
Bore mm	102 mm (4.02 in.)
Stroke mm	120 mm (4.72 in.)
Displacement Litre	5.9 litre (360.0 in. ³)
Cylinder Block	Cast iron, 6 cylinder
Battery Charging Alternator	55 amps
Starting Voltage	12 volt, 55 Amp negative ground
Fuel System	Direct injection
Fuel Filter	Venturi Combo Stratapore Filter
Lube Oil Filter Type(s)	Venturi Combo Stratapore Filter
Lube Oil Capacity (l)	16.4
Flywheel Dimensions	SAE3/11.5

Coolpac Performance Data

Cooling System Design	Charged Air Cooled
Coolant Ratio	50% ethylene glycol; 50% water
Total Coolant Capacity (l)	21.4
Limiting Ambient Temp**	50 Degrees
Fan Power (kWm)	10
Cooling System Air Flow (m ³ /s)**	3.7
Air Cleaner Type (heavy duty)	Dry replaceable element with restriction indicator

** @ 13 mm H₂O

Weight and Dimensions

	Length	Width	Height	Weight (dry)
	mm	mm	mm	kg
CoolPac	1723	896	1380	718

Fuel Consumption 1500 (50 Hz)

%	kWm	BHP	L/ph	US gal/ph
Standby Power				
100	160	215	41	10.9
Prime Power				
100	145	195	37	9.8
75	109	146	29	7.5
50	73	98	19	5.0
25	36	49	9	2.5
Continuous Power				
100	101	135	26	6.9

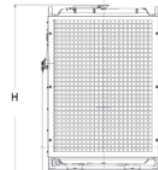

Ratings Definitions

Emergency Standby Power (ESP):

Applicable for supplying power to varying electrical load for the duration of power interruption of a reliable utility source. Emergency Standby Power (ESP) is in accordance with ISO 8528, Fuel Stop power in accordance with ISO 3046, AS 2789, DIN 6271 and BS 5514.

Limited-Time Running Power (LTP):

Applicable for supplying power to a constant electrical load for limited hours. Limited-Time Running Power (LTP) is in accordance with ISO 8528.

Prime Power (PRP):

Applicable for supplying power to varying electrical load for unlimited hours. Prime Power (PRP) is in accordance with ISO 8528. Ten percent overload capability is available in accordance with ISO 3046, AS 2789, DIN 6271 and BS 5514.

Base Load (Continuous) Power (COP):

Applicable for supplying power continuously to a constant electrical load for unlimited hours. Continuous Power (COP) is in accordance with ISO 8528, ISO 3046, AS 2789, DIN6271 and BS 5514.

Cummins G-Drive Engines

Asia Pacific

10 Toh Guan Road
#07-01
TT International Tradepark
Singapore 608838
Phone 65 6417 2388
Fax 65 6417 2399

Europe, CIS, Middle East and Africa

Manston Park Columbus Ave
Manston Ramsgate
Kent CT12 5BF, UK
Phone 44 1843 255000
Fax 44 1843 255902

Latin America

Rua Jati, 310, Cumbica
Guarulhos, SP 07180-900
Brazil
Phone 55 11 2186 4552
Fax 55 11 2186 4729

Mexico

Cummins S. de R.L. de C.V.
Eje 122 No. 200 Zona Industrial
San Luis Potosí, S.L.P. 78090
Mexico
Phone 52 444 870 6700
Fax 52 444 870 6811

North America

1400 73rd Avenue N.E.
Minneapolis, MN 55432
USA
Phone 1 763 574 5000
USA Toll-free 1 877 769 7669
Fax 1 763 574 5298





S3.8-G4

Fuel Optimized



Description

The Cummins 'S Series' engine powered CoolPac sets offer the lowest cost of maintenance thereby proving to be the most economical power solution. With the robust design and integrated technologies, the S Series CoolPac can command an unrivalled reputation for reliability and performance.

The S series Engines have a distinguished reputation and long history for durability.

The rugged and reliable Cummins 'S Series' Engines gives you a compact high performance engine design for your generator application.



This engine has been designed in facilities certified to ISO9001 and manufactured in facilities certified to ISO9001 or ISO9002.

Features

Bosch - Direct injection in-line pump for cleaner, more efficient fuel consumption.

12 volt electrics package as standard, with starter, alternator and fuel solenoid.

SAE '3/10' flywheel.

Low-Maintenance Fuel Filter Assembly – The Fuel filter Incorporates an integral water drain facility and a 500-hour filter life using standard Fleetguard® filters.

Low-Maintenance Lube Oil Filter Assembly – The Lube Oil filter also has a 500-hour filter life using standard Fleetguard® filters.

Integrated Design - CoolPac products are supplied fitted with cooling package and medium duty air cleaner for a complete power package. Each component has been specifically developed and rigorously tested for G-Drive products, ensuring high performance, durability and reliability.

Service and Support - G-Drive products are backed by an uncompromising level of technical support and after sales service, delivered through a world class service network.

1500 rpm (50 Hz ratings)

Gross engine output			Net engine output			Typical generator set output					
Standby	Prime	Base	Standby	Prime	Base	Standby (ESP)		Prime (PRP)		Base (COP)	
kWm/BHP			kWm/BHP			kWe	kVA	kWe	kVA	kWe	kVA
43.4/58.2	38.7/51.9	27.1/36.3	41.4/55.5	36.7/49.1	25.1/33.6	35	44	32	40	22.4	28

1800 rpm (60 Hz ratings)

Gross engine output			Net engine output			Typical generator set output					
Standby	Prime	Base	Standby	Prime	Base	Standby (ESP)		Prime (PRP)		Base (COP)	
kWm/BHP			kWm/BHP			kWe	kVA	kWe	kVA	kWe	kVA
-	-	-	-	-	-	-	-	-	-	-	-

General engine data

Type	In line, Radiator cooled
Bore mm	97 mm (3.82 in.)
Stroke mm	128 mm (5.0 in.)
Displacement litre	3.8 litre (232 in. ³)
Cylinder block	Cast iron, 4 cylinder
Battery charging alternator	12V, 35 amps
Starting voltage	12 volt, negative ground
Fuel system	Direct injection
Fuel filter	Spin-on
Lube oil filter type(s)	Spin-on
Lube oil capacity (l)	10
Flywheel dimensions	SAE3/10

Coolpac performance data

Cooling system design	Jacket Water cooled
Coolant ratio	50% ethylene glycol; 50% water
Coolant capacity (l)	11
Limiting ambient temp.** (°C)	50
Fan power (kWm)	2
Cooling system air flow (m ³ /s)**	0.84
Air cleaner type	Dry type, replaceable, medium duty

** @ 0.25" H2O

Fuel consumption 1500 (50 Hz)

%	kWm	BHP	L/ph	g/kWh
Standby Power				
100	43.4	58.2	11.2	3
Prime Power				
100	38.7	51.9	9.9	2.6
75	28.9	38.9	7.6	2.0
50	21.5	28.8	5.4	1.4
25	9.7	13	3.5	0.9
Continuous Power				
100	27	36	7.2	1.9

Fuel consumption 1800 (60 Hz)

%	kWm	BHP	L/ph	g/kWh
Standby Power				
100	-	-	-	-
Prime Power				
100	-	-	-	-
75	-	-	-	-
50	-	-	-	-
25	-	-	-	-
Continuous Power				
100	-	-	-	-

Weights and dimensions

Length mm	Width mm	Height mm	Weight (dry) kg
1135	740	980	450

Ratings definitions

Emergency Standby Power (ESP):	Limited-Time Running Power (LTP):	Prime Power (PRP):	Base Load (Continuous) Power (COP):
Applicable for supplying power to varying electrical load for the duration of power interruption of a reliable utility source. Emergency Standby Power (ESP) is in accordance with ISO 8528. Fuel Stop power in accordance with ISO 3046, AS 2789, DIN 6271 and BS 5514.	Applicable for supplying power to a constant electrical load for limited hours. Limited-Time Running Power (LTP) is in accordance with ISO 8528.	Applicable for supplying power to varying electrical load for unlimited hours. Prime Power (PRP) is in accordance with ISO 8528. Ten percent overload capability is available in accordance with ISO 3046, AS 2789, DIN 6271 and BS 5514.	Applicable for supplying power continuously to a constant electrical load for unlimited hours. Continuous Power (COP) in accordance with ISO 8528, ISO 3046, AS 2789, DIN6271 and BS 5514.

For more information contact your local Cummins distributor

Our energy working for you.™



QSZ13-G5

Emissions Compliance:
EU Stage II @ 50 Hz
U.S. EPA Tier 2 @ 60 Hz



> Specification sheet

Our energy working for you.™



Description

The QSZ13 engine is designed to meet the European Union (EU) Stage II and EPA Tier 2 generator set emission standards. Evolved from the proven and successful base engine platform of an automotive engine, which is widely accepted for its high levels of in-service reliability and performance, the QSZ13 engine utilizes the Cummins High Pressure Injection (XPI) fuel system.

The QSZ13 engine was developed using Cummins unique in-house capability, adapting core technologies in electronics, fuel systems, turbo charging, filtration, and emissions. The QSZ13 engine has low derating thresholds for temperature and altitude, coupled with 50°C ambient capable cooling system makes these engines top performers in the harshest conditions.

Robust, clean, resilient and capable of matching the duty cycle and operating conditions of many applications, the QSZ13 engine is ideally suited for both open and enclosed applications in either static or mobile equipment.



This engine has been built to comply with CE certification.



This engine has been designed in facilities certified to ISO9001 and manufactured in facilities certified to ISO9001 or ISO9002.

Features

Coolpac Integrated Design - Products are supplied complete with cooling package and air cleaner kit for a complete power package. A Heavy duty air cleaner is offered as an option.

Full Authority Electronic Dual Speed Engine - Advanced engine monitoring, diagnostics, protection and control, coupled with the XPI fuel system, capable of delivering extreme fuel injection pressures with multiple injection events, results in reduced emissions, improved fuel efficiency, lower noise and enhanced engine performance.

Fuel Filtration System – Three-stage fuel filtration system provides high levels of protection against fuel becoming contaminated with dust, dirt, or water.

Controls - Fitted with a Power Generation Interface (PGI) to improve emissions, the widely accepted SAE J1939 industry standard CAN based communication network provides advanced engine protection, ensuring faster connectivity along with a superior fault finding capability.

Crankcase Breather – Cummins patented variable impactor breather design and coalescing filter removes emissions as required by regulations, with the added benefit of eliminating oil drips and mist while keeping the surroundings clean.

Reduced Operating Costs – Extended service intervals for the oil and filter changes.

Service and Support – G-Drive products are backed by an uncompromising level of technical support and after sales support, delivered through a world class service network.

1500 rpm (50 Hz Ratings)

Gross Engine Output			Net Engine Output			Typical Generator Set Output					
Standby	Prime	Base	Standby	Prime	Base	Standby (ESP)		Prime (PRP)		Base (COP)	
kWm/BHP			kWm/BHP			kWe	kVA	kWe	kVA	kWe	kVA
470/630	411/551	370/496	452/605	393/526	352/470	400	500	364	455	330	413

1800 rpm (60 Hz Ratings)

Gross Engine Output			Net Engine Output			Typical Generator Set Output					
Standby	Prime	Base	Standby	Prime	Base	Standby (ESP)		Prime (PRP)		Base (COP)	
kWm/BHP			kWm/BHP			kWe	kVA	kWe	kVA	kWe	kVA
500/670	437/586	393/527	482/645	440/589	394/528	440	550	400	500	348	435



General Engine Data

Type	4 Cycle, In-line, Turbocharged and Charge Air Cooled
Bore	130 mm (5.12 in.)
Stroke	163 mm (6.42 in.)
Displacement	13 litre (793 in. ³)
Cylinder Block	Cast iron, 6 cylinder
Battery Charging Alternator	35 amps
Starting Voltage	24 volt
Fuel System	XPI
Fuel Filter	Engine mounted, primary spin-on fuel filter, 7 micron, with water separator & Water in Fuel (WIF) sensor and secondary 3 micron spin-on fuel filter. Remote mounted 10 micron pre fuel filter supplied as standard scope.
Lube Oil Filter Type(s)	Spin-on full flow filter
Lube Oil Capacity	78 litre
Flywheel Dimensions	SAE1

Coolpac Performance Data

Cooling System Design	Air to Air, Charge Air Cooled
Coolant Ratio	50% ethylene glycol; 50% water
Total Coolant Capacity	62 litre
Limiting Ambient Temp. **	50° C
Fan Power (kWm)	18.1 (50 Hz), 31.5 (60 Hz)
Cooling System Air Flow (m ³ /s)**	8.1 (50 Hz), 10.3 (60 Hz)
Air Cleaner Type	Normal Duty dry replaceable element with restriction Indicator

** @ 13 mm H₂O duct restriction

Weight & Dimensions

Length	Width	Height	Weight (dry)
mm	mm	mm	kg
1389	1276	1050	1,245

Fuel Consumption 1500 (50 Hz)

%	kWm	BHP	L/h	US gal/h
Standby Power				
100	470	630	107	28.3
Prime Power				
100	411	551	93	24.6
75	308	413	70	18.6
50	205	275	49	13
25	103	138	30	7.9
Continuous Power				
100	370	496	84	22.2

Fuel Consumption 1800 (60 Hz)

%	kWm	BHP	L/h	US gal/h
Standby Power				
100	500	670	117	30.9
Prime Power				
100	437	586	107	28.3
75	328	440	81	21.4
50	218	293	54	14.3
25	110	147	35	9.2
Continuous Power				
100	393	527	96	25.4

Cummins G-Drive Engines

Asia Pacific

10 Toh Guan Road
#07-01
TT International Tradepark
Singapore 608838
Phone 65 6417 2388
Fax 65 6417 2399

Europe, CIS, Middle East and Africa

Manston Park Columbus Ave
Manston Ramsgate
Kent CT12 5BF. UK
Phone 44 1843 255000
Fax 44 1843 255902

Latin America

Rua Jati, 310, Cumbica
Guarulhos, SP 07180-900
Brazil
Phone 55 11 2186 4552
Fax 55 11 2186 4729

Mexico

Cummins S. de R.L. de C.V.
Eje 122 No. 200 Zona Industrial
San Luis Potosi, S.L.P. 78090
Mexico
Phone 52 444 870 6700
Fax 52 444 870 6811

North America

1400 73rd Avenue N.E.
Minneapolis, MN 55432
USA
Phone 1 763 574 5000
USA Toll-free 1 877 769 7669
Fax 1 763 574 5298

Ratings Definitions

Emergency Standby Power (ESP):

Applicable for supplying power to varying electrical load for the duration of power interruption of a reliable utility source. Emergency Standby Power (ESP) is in accordance with ISO 8528. Fuel Stop power in accordance with ISO 3046, AS 2789, DIN 6271 and BS 5514.

Limited-Time Running Power (LTP):

Applicable for supplying power to a constant electrical load for limited hours. Limited-Time Running Power (LTP) is in accordance with ISO 8528.

Prime Power (PRP):

Applicable for supplying power to varying electrical load for unlimited hours. Prime Power (PRP) is in accordance with ISO 8528. Ten percent overload capability is available in accordance with ISO 3046, AS 2789, DIN 6271 and BS 5514.

Base Load (Continuous) Power (COP):

Applicable for supplying power continuously to a constant electrical load for unlimited hours. Continuous Power (COP) in accordance with ISO 8528, ISO 3046, AS 2789, DIN6271 and BS 5514.



HCI 534C/544C - Technical Data Sheet

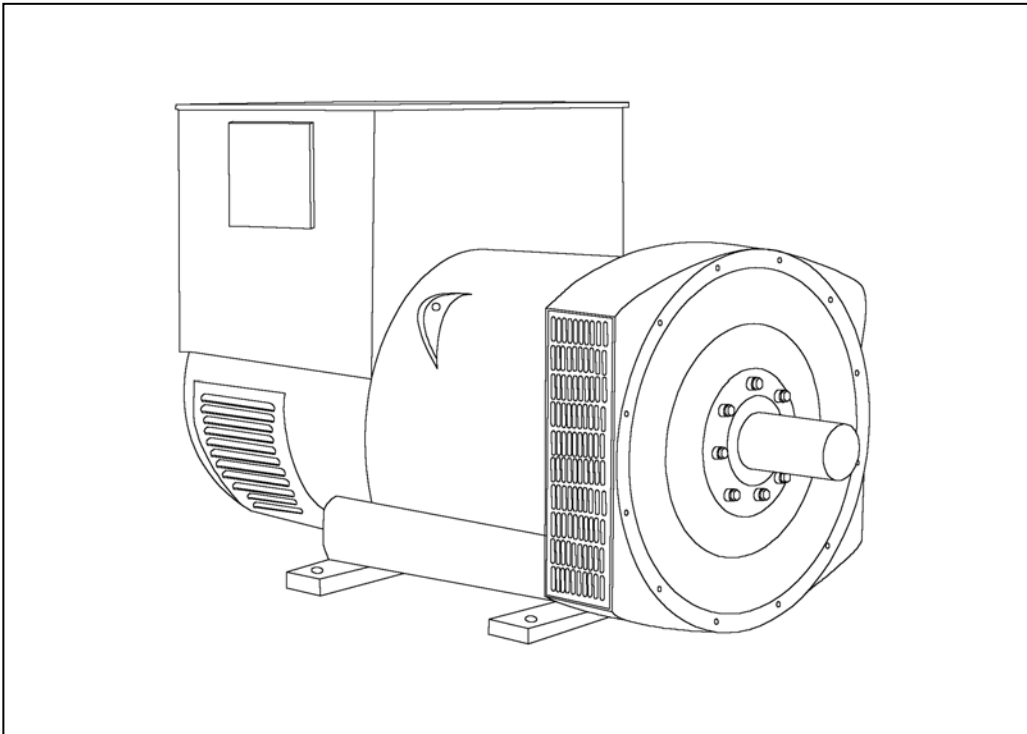

HCI534C/544C

SPECIFICATIONS & OPTIONS



STANDARDS

Newage Stamford industrial generators meet the requirements of BS EN 60034 and the relevant section of other international standards such as BS5000, VDE 0530, NEMA MG1-32, IEC34, CSA C22.2-100, AS1359. Other standards and certifications can be considered on request.

VOLTAGE REGULATORS

SX440 AVR - STANDARD

With this self-excited system the main stator provides power via the Automatic Voltage Regulator (AVR) to the exciter stator. The high efficiency semi-conductors of the AVR ensure positive build-up from initial low levels of residual voltage.

The exciter rotor output is fed to the main rotor through a three-phase full-wave bridge rectifier. The rectifier is protected by a surge suppressor against surges caused, for example, by short circuit or out-of-phase paralleling.

The SX440 will support a range of electronic accessories, including a 'droop' Current Transformer (CT) to permit parallel operation with other ac generators.

If 3-phase sensing is required with the self-excited system, the SX421 AVR must be used.

SX421 AVR

This AVR also operates in a self-excited system. It combines all the features of the SX440 with, additionally, three-phase rms sensing for improved regulation and performance. Over voltage protection is provided via a separate circuit breaker. An engine relief load acceptance feature is built in as standard.

MX341 AVR

This sophisticated AVR is incorporated into the Stamford Permanent Magnet Generator (PMG) control system.

The PMG provides power via the AVR to the main exciter, giving a source of constant excitation power independent of generator output. The main exciter output is then fed to the main rotor, through a full wave bridge, protected by a surge suppressor. The AVR has in-built protection against sustained over-excitation, caused by internal or external faults. This de-excites the machine after a minimum of 5 seconds.

An engine relief load acceptance feature can enable full load to be applied to the generator in a single step.

If three-phase sensing is required with the PMG system the MX321 AVR must be used.

We recommend three-phase sensing for applications with greatly unbalanced or highly non-linear loads.

MX321 AVR

The most sophisticated of all our AVRs combines all the features of the MX341 with, additionally, three-phase rms sensing, for improved regulation and performance.

Over voltage protection is built-in and short circuit current level adjustments is an optional facility.

WINDINGS & ELECTRICAL PERFORMANCE

All generator stators are wound to 2/3 pitch. This eliminates triplen (3rd, 9th, 15th ...) harmonics on the voltage waveform and is found to be the optimum design for trouble-free supply of non-linear loads. The 2/3 pitch design avoids excessive neutral currents sometimes seen with higher winding pitches, when in parallel with the mains. A fully connected damper winding reduces oscillations during paralleling. This winding, with the 2/3 pitch and carefully selected pole and tooth designs, ensures very low waveform distortion.

TERMINALS & TERMINAL BOX

Standard generators are 3-phase reconnectable with 12 ends brought out to the terminals, which are mounted on a cover at the non-drive end of the generator. A sheet steel terminal box contains the AVR and provides ample space for the customers' wiring and gland arrangements. It has removable panels for easy access.

SHAFT & KEYS

All generator rotors are dynamically balanced to better than BS6861:Part 1 Grade 2.5 for minimum vibration in operation. Two bearing generators are balanced with a half key.

INSULATION/IMPREGNATION

The insulation system is class 'H'.

All wound components are impregnated with materials and processes designed specifically to provide the high build required for static windings and the high mechanical strength required for rotating components.

QUALITY ASSURANCE

Generators are manufactured using production procedures having a quality assurance level to BS EN ISO 9001.

The stated voltage regulation may not be maintained in the presence of certain radio transmitted signals. Any change in performance will fall within the limits of Criteria 'B' of EN 61000-6-2:2001. At no time will the steady-state voltage regulation exceed 2%.

NB Continuous development of our products entitles us to change specification details without notice, therefore they must not be regarded as binding.

Front cover drawing typical of product range.

HCI534C/544C

WINDING 311

CONTROL SYSTEM	SEPARATELY EXCITED BY P.M.G.							
A.V.R.	MX321	MX341						
VOLTAGE REGULATION	± 0.5 %	± 1.0 %	With 4% ENGINE GOVERNING					
SUSTAINED SHORT CIRCUIT	REFER TO SHORT CIRCUIT DECREMENT CURVES (page 7)							
CONTROL SYSTEM	SELF EXCITED							
A.V.R.	SX440	SX421						
VOLTAGE REGULATION	± 1.0 %	± 0.5 %	With 4% ENGINE GOVERNING					
SUSTAINED SHORT CIRCUIT	SERIES 4 CONTROL DOES NOT SUSTAIN A SHORT CIRCUIT CURRENT							
INSULATION SYSTEM	CLASS H							
PROTECTION	IP23							
RATED POWER FACTOR	0.8							
STATOR WINDING	DOUBLE LAYER LAP							
WINDING PITCH	TWO THIRDS							
WINDING LEADS	12							
STATOR WDG. RESISTANCE	0.0065 Ohms PER PHASE AT 22°C SERIES STAR CONNECTED							
ROTOR WDG. RESISTANCE	1.55 Ohms at 22°C							
R.F.I. SUPPRESSION	BS EN 61000-6-2 & BS EN 61000-6-4,VDE 0875G, VDE 0875N. refer to factory for others							
WAVEFORM DISTORTION	NO LOAD < 1.5% NON-DISTORTING BALANCED LINEAR LOAD < 5.0%							
MAXIMUM OVERSPEED	2250 Rev/Min							
BEARING DRIVE END	BALL. 6220 (ISO)							
BEARING NON-DRIVE END	BALL. 6314 (ISO)							
	1 BEARING				2 BEARING			
WEIGHT COMP. GENERATOR	1263 kg				1275 kg			
WEIGHT WOUND STATOR	584 kg				584 kg			
WEIGHT WOUND ROTOR	502 kg				473 kg			
WR ² INERTIA	6.8928 kgm ²				6.6149 kgm ²			
SHIPPING WEIGHTS in a crate	1355 kg				1395 kg			
PACKING CRATE SIZE	166 x 87 x 124(cm)				166 x 87 x 124(cm)			
	50 Hz				60 Hz			
TELEPHONE INTERFERENCE	THF<2%				TIF<50			
COOLING AIR	1.035 m ³ /sec 2202 cfm				1.312 m ³ /sec 2780 cfm			
VOLTAGE SERIES STAR	380/220	400/231	415/240	440/254	416/240	440/254	460/266	480/277
VOLTAGE PARALLEL STAR	190/110	200/115	208/120	220/127	208/120	220/127	230/133	240/138
VOLTAGE SERIES DELTA	220/110	230/115	240/120	254/127	240/120	254/127	266/133	277/138
KVA BASE RATING FOR REACTANCE VALUES	450	450	450	450	525	550	581	594
X _d DIR. AXIS SYNCHRONOUS	3.27	2.95	2.74	2.44	3.94	3.69	3.57	3.35
X' _d DIR. AXIS TRANSIENT	0.18	0.16	0.15	0.13	0.18	0.17	0.16	0.15
X'' _d DIR. AXIS SUBTRANSIENT	0.13	0.12	0.11	0.10	0.13	0.12	0.12	0.11
X _q QUAD. AXIS REACTANCE	2.66	2.40	2.23	1.98	3.12	2.92	2.82	2.65
X'' _q QUAD. AXIS SUBTRANSIENT	0.26	0.24	0.22	0.20	0.34	0.32	0.31	0.29
X _L LEAKAGE REACTANCE	0.07	0.06	0.06	0.05	0.08	0.07	0.07	0.07
X ₂ NEGATIVE SEQUENCE	0.19	0.17	0.16	0.14	0.23	0.22	0.21	0.20
X ₀ ZERO SEQUENCE	0.11	0.10	0.09	0.08	0.11	0.10	0.10	0.09
REACTANCES ARE SATURATED VALUES ARE PER UNIT AT RATING AND VOLTAGE INDICATED								
T' _d TRANSIENT TIME CONST.	0.08s							
T'' _d SUB-TRANSTIME CONST.	0.012s							
T' _{do} O.C. FIELD TIME CONST.	2s							
T _a ARMATURE TIME CONST.	0.017s							
SHORT CIRCUIT RATIO	1/X _d							

**50
Hz**

HCI534C/544C
Winding 311



THREE PHASE EFFICIENCY CURVES

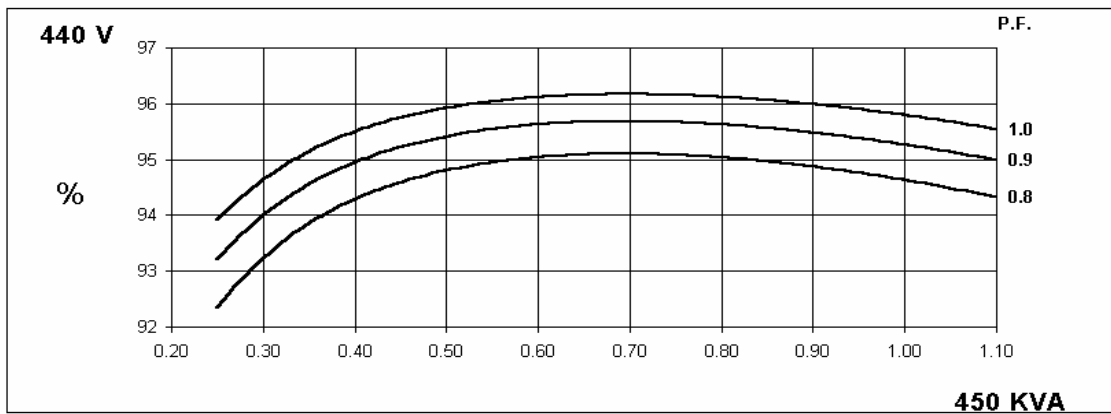
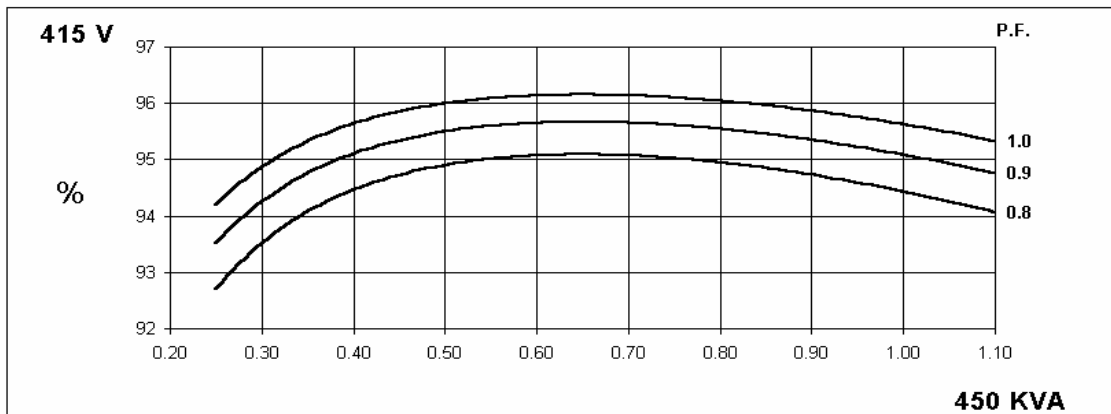
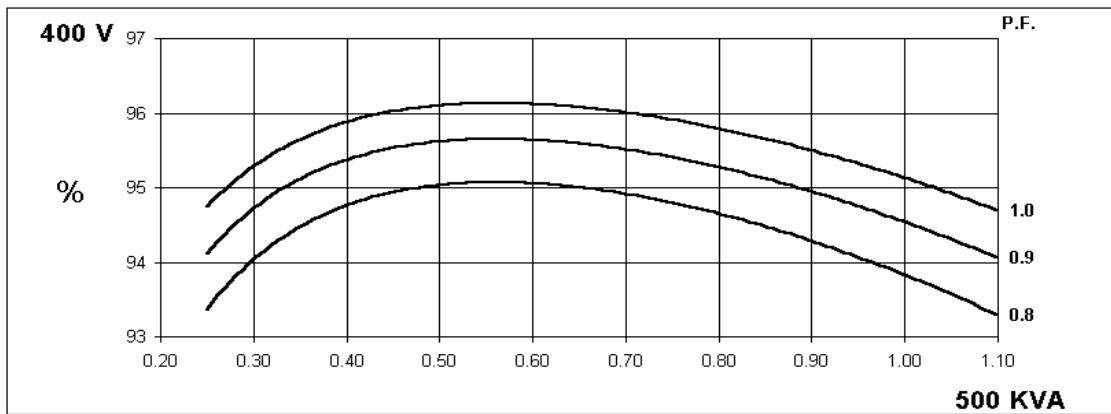
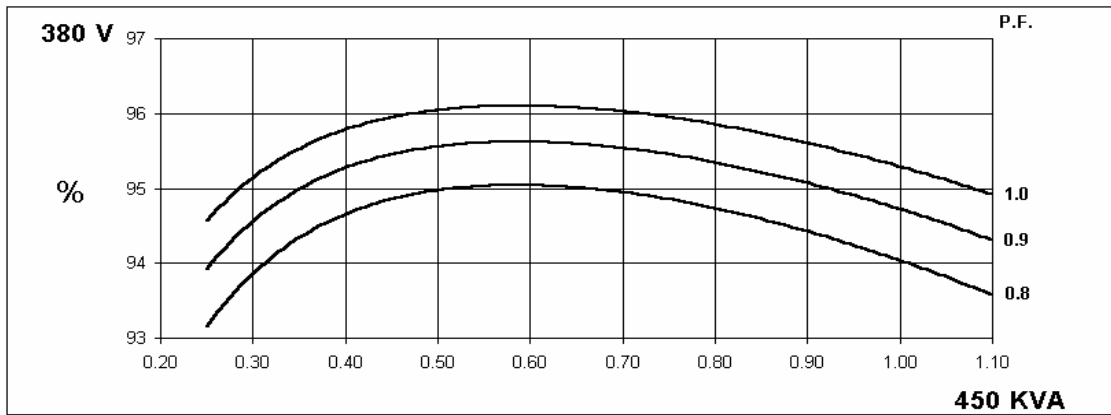

THREE PHASE EFFICIENCY CURVES

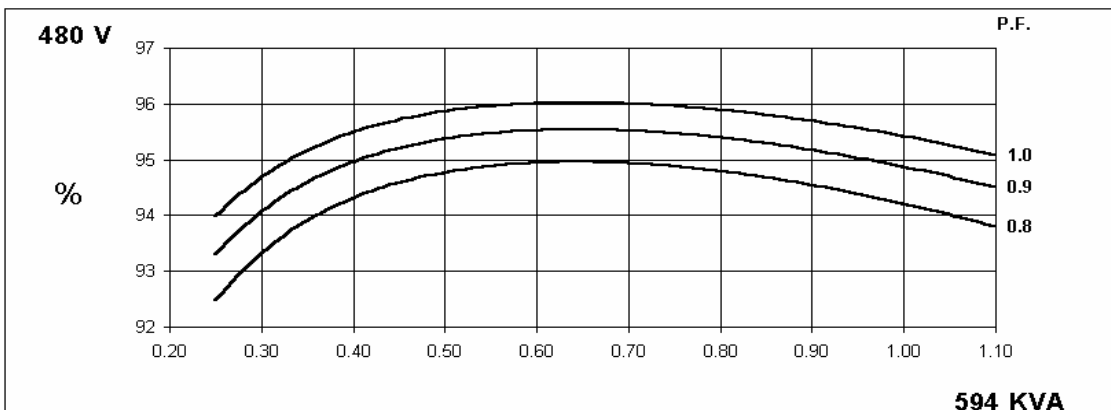
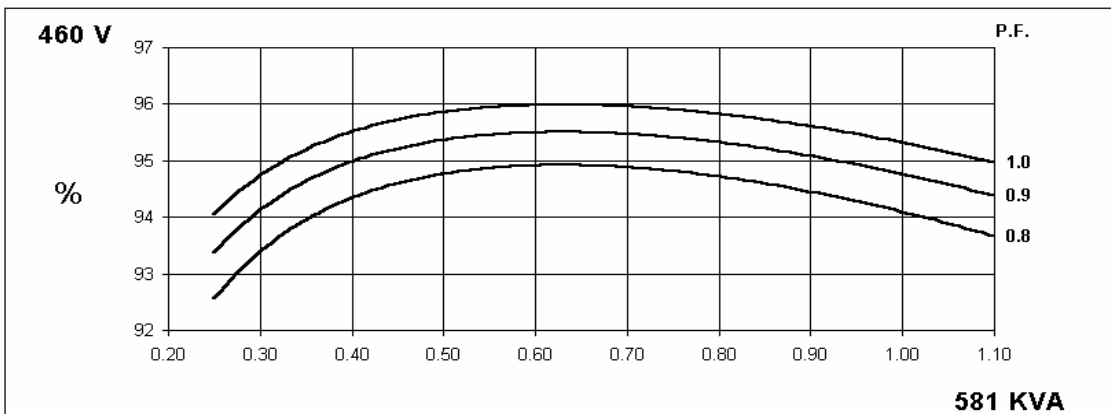
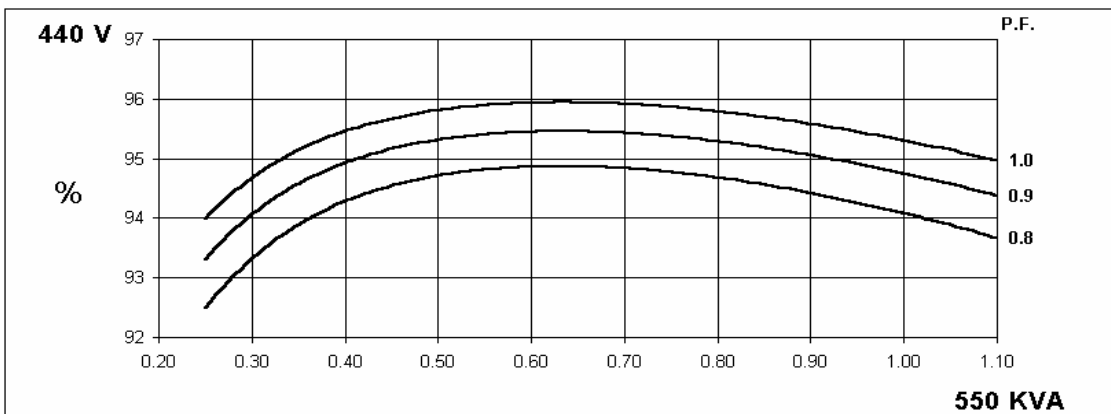
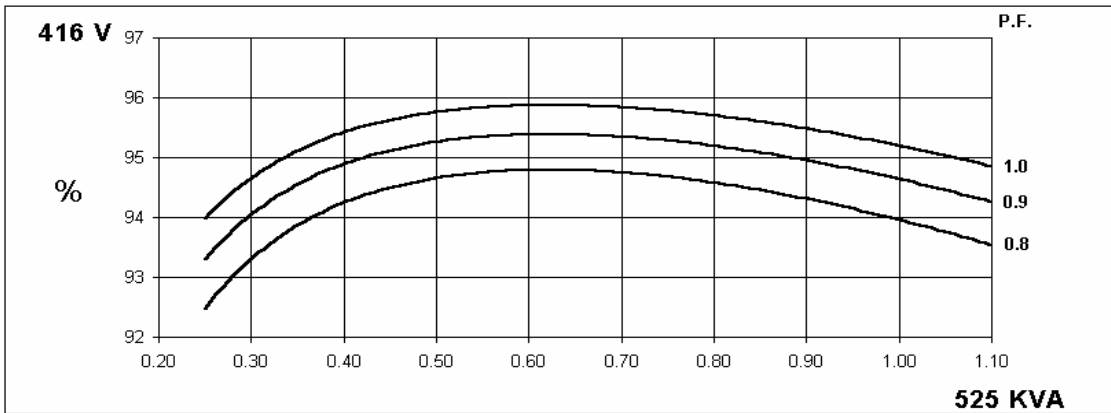

HCI534C/544C

Winding 311



Locked Rotor Motor Starting Curve

**50
Hz**

MX

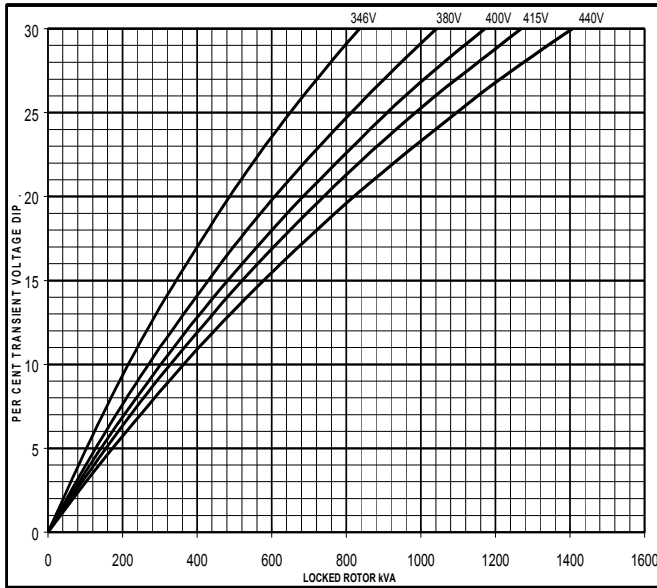

SX

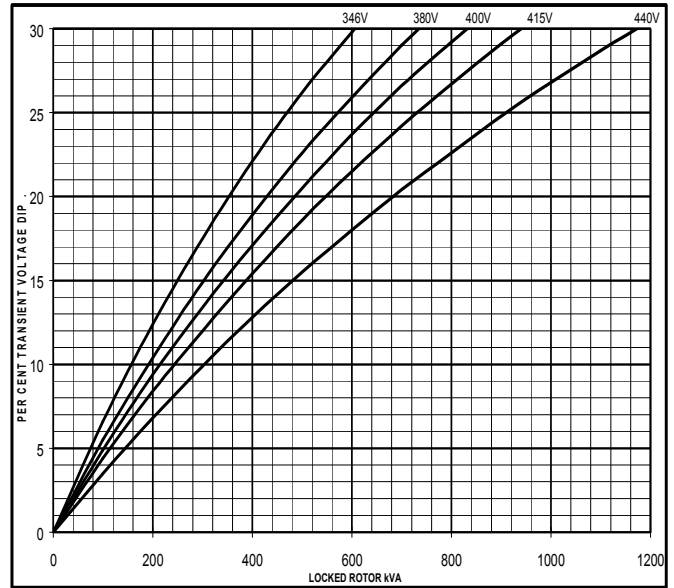

**60
Hz**

MX

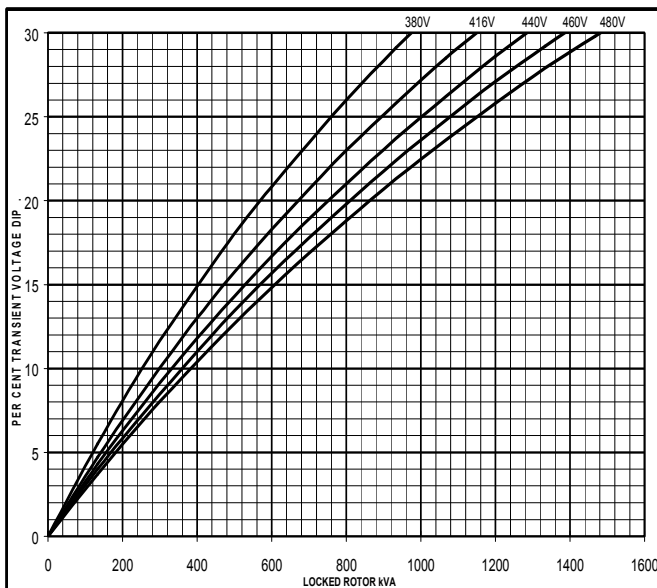

SX

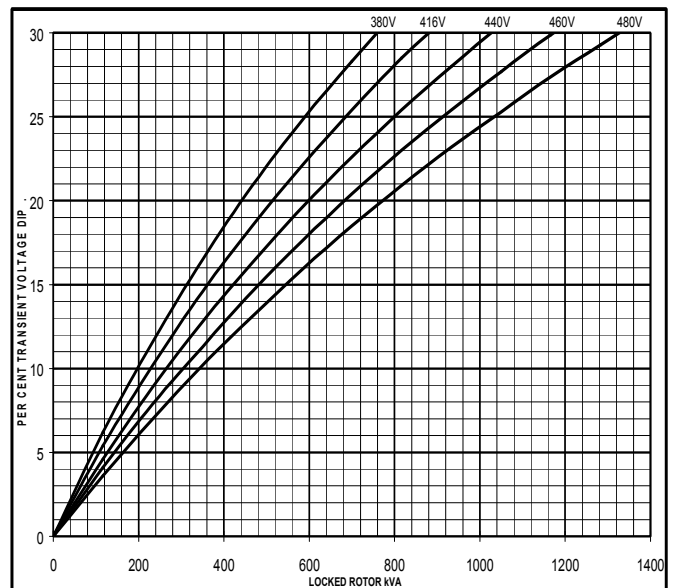

**Three-phase Short Circuit Decrement Curve. No-load Excitation at Rated Speed
Based on star (wye) connection.**

**50
Hz**

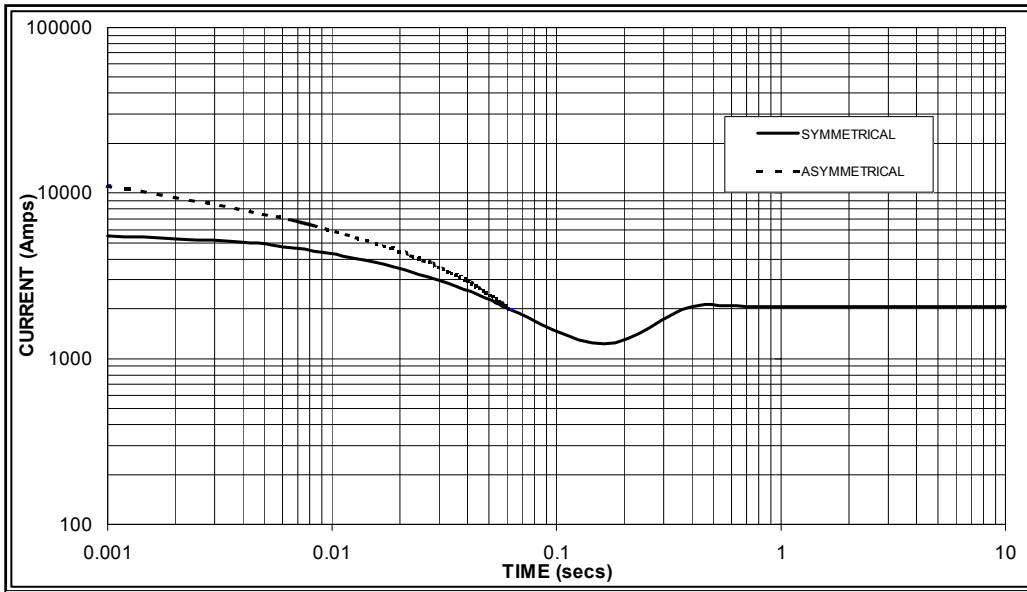

Sustained Short Circuit = 2,050 Amps

**60
Hz**

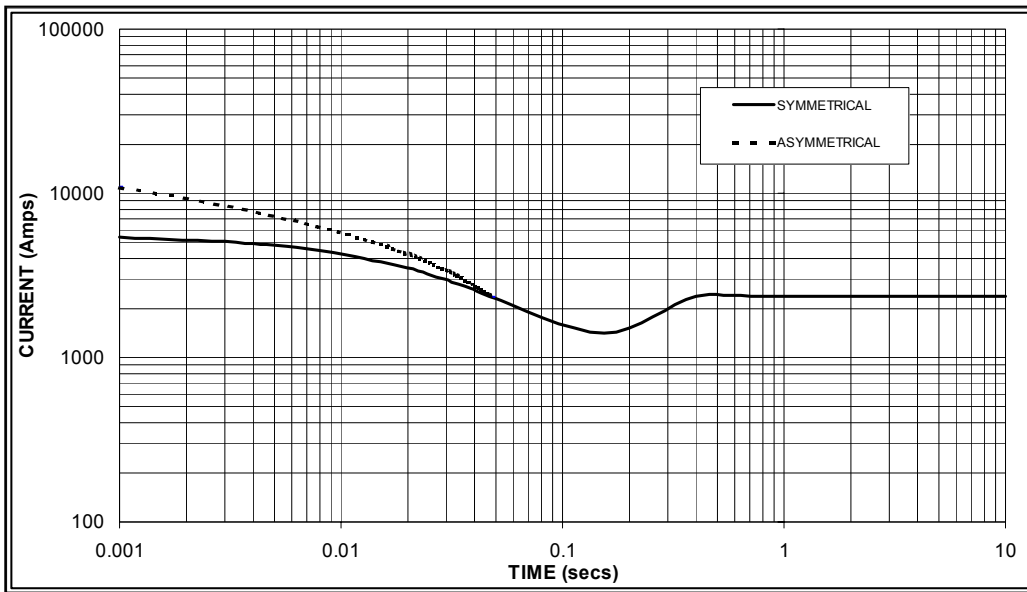

Sustained Short Circuit = 2,350 Amps

Note 1

The following multiplication factors should be used to adjust the values from curve between time 0.001 seconds and the minimum current point in respect of nominal operating voltage :

50Hz		60Hz	
Voltage	Factor	Voltage	Factor
380v	X 1.00	416v	X 1.00
400v	X 1.03	440v	X 1.06
415v	X 1.05	460v	X 1.12
440v	X 1.07	480v	X 1.20

The sustained current value is constant irrespective of voltage level

Note 2

The following multiplication factor should be used to convert the values calculated in accordance with NOTE 1 to those applicable to the various types of short circuit :

	3-phase	2-phase L-L	1-phase L-N
Instantaneous	x 1.00	x 0.87	x 1.30
Minimum	x 1.00	x 1.80	x 3.20
Sustained	x 1.00	x 1.50	x 2.50
Max. sustained duration	10 sec.	5 sec.	2 sec.

All other times are unchanged

Note 3

Curves are drawn for Star (Wye) connected machines. For other connection the following multipliers should be applied to current values as shown :

Parallel Star = Curve current value X 2

Series Delta = Curve current value X 1.732

HCI534C/544C

Winding 311 0.8 Power Factor



RATINGS

Class - Temp Rise	Cont. F - 105/40°C				Cont. H - 125/40°C				Standby - 150/40°C				Standby - 163/27°C				
50 Hz	Series Star (V)	380	400	415	440	380	400	415	440	380	400	415	440	380	400	415	440
	Parallel Star (V)	190	200	208	220	190	200	208	220	190	200	208	220	190	200	208	220
	Series Delta (V)	220	230	240	254	220	230	240	254	220	230	240	254	220	230	240	254
	kVA	400	445	400	400	450	500	450	450	478	512	478	478	495	520	495	495
	kW	320	356	320	320	360	400	360	360	382	410	382	382	396	416	396	396
	Efficiency (%)	94.5	94.3	94.8	94.9	94.0	93.8	94.4	94.6	93.8	93.7	94.2	94.4	93.6	93.6	94.1	94.3
	kW Input	339	378	338	337	383	426	381	381	408	437	406	405	423	444	421	420

60 Hz	Series Star (V)	416	440	460	480	416	440	460	480	416	440	460	480	416	440	460	480
	Parallel Star (V)	208	220	230	240	208	220	230	240	208	220	230	240	208	220	230	240
	Delta (V)	240	254	266	277	240	254	266	277	240	254	266	277	240	254	266	277
	kVA	481	500	531	538	525	550	581	594	550	581	613	625	569	600	631	644
	kW	385	400	425	430	420	440	465	475	440	465	490	500	455	480	505	515
	Efficiency (%)	94.3	94.4	94.4	94.5	94.0	94.1	94.1	94.2	93.8	93.9	93.9	94.0	93.6	93.7	93.7	93.9
	kW Input	408	424	450	455	447	468	494	504	469	495	522	532	486	512	539	549

DIMENSIONS

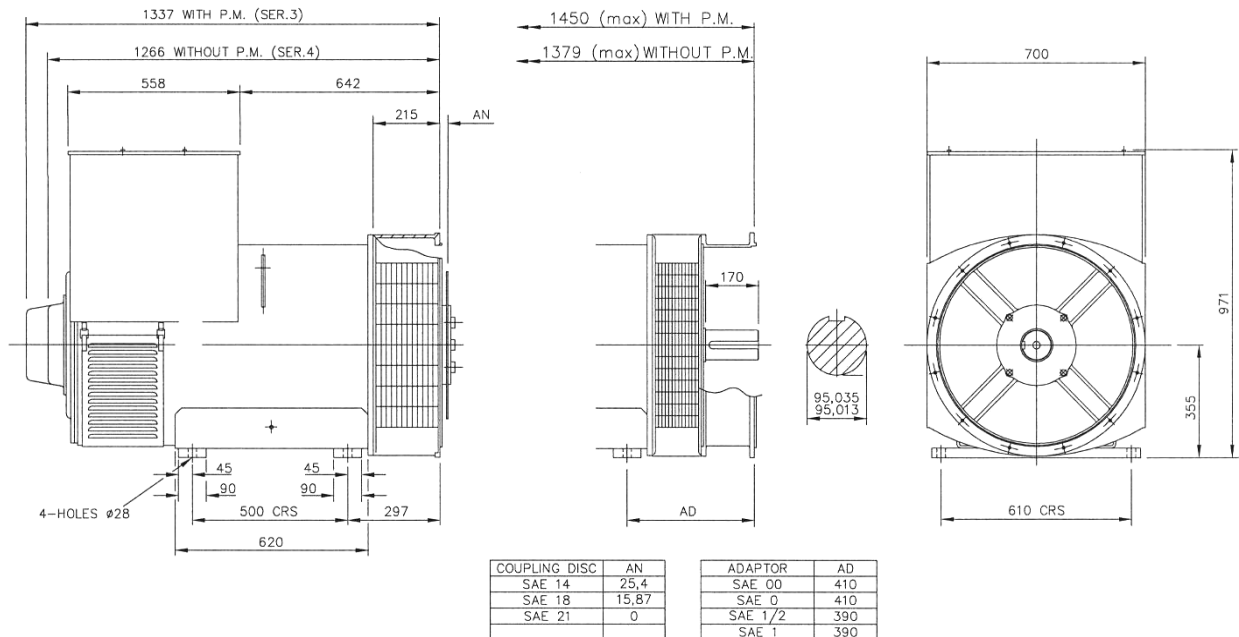

PO Box 17 • Barnack Road • Stamford • Lincolnshire • PE9 2NB
Tel: 00 44 (0)1780 484000 • Fax: 00 44 (0)1780 484100

QSX15-G8

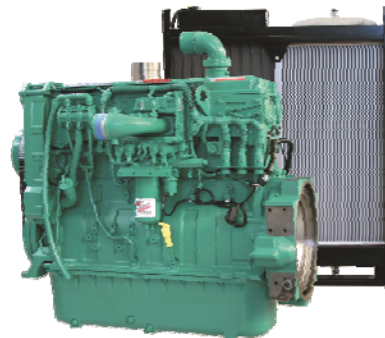

Emissions Compliance:

Non-Certified or "Flex" program for EU Mobile applications.
Formerly EU Stage2 @ 50Hz.

> Specification sheet



Our energy working for you.™

Description

The QSX15-Series is the first heavy-duty diesel with 24-valve dual overhead camshaft technology. Yet it has an impressive 30% fewer parts than comparable diesels and a utilised design, which eliminates external lube, coolant and fuel lines, leading to higher reliability for such a high power output.

The 15 litre, six-cylinder QSX15 engine is ideally suited to both open and containerised applications in static or portable genset equipment. It can be matched to meet specific duty cycle and operating conditions of any genset.



This engine has been built to comply with CE certification.



This engine has been designed in facilities certified to ISO9001 and manufactured in facilities certified to ISO9001 or ISO9002.

Features

Holset HX82 Turbocharging - Wastegated design optimizes operation. Improved transient response and low fuel consumption.

Integrated Block Design - Integrated fluid circuits replace hoses and eliminate potential leaks.

High-Pressure Fuel Injection - Capable of over 1,900 bar (28,000 psi) for cleaner, more fuel-efficient combustion.

24-Valve Cylinder Head – Four valves per cylinder for increased power with faster response at every rpm.

Coolpac Integrated Design - Products are supplied complete with cooling package and air cleaner kit for a complete power package. Each component has been specifically developed and rigorously tested for G-Drive products, ensuring high performance, durability and reliability.

Controls - Fitted with Power Generation Interface (PGI) to improve emissions.

Service and Support - G-Drive products are backed by an uncompromising level of technical support and after sales service, delivered through a world class service network.

1500 rpm (50 Hz Ratings)

Gross Engine Output			Net Engine Output			Typical Generator Set Output					
Standby	Prime	Base	Standby	Prime	Base	Standby (ESP)		Prime (PRP)		Base (COP)	
kWm/BHP			kWm/BHP			kWe	kVA	kWe	kVA	kWe	kVA
500/670	444/595	317/425	477/639	426/571	299/400	440	550	400	500	281	351

1800 rpm (60 Hz Ratings)

Gross Engine Output			Net Engine Output			Typical Generator Set Output					
Standby	Prime	Base	Standby	Prime	Base	Standby (ESP)		Prime (PRP)		Base (COP)	
kWm/BHP			kWm/BHP			kWe	kVA	kWe	kVA	kWe	kVA
455/610	414/555	295/395	419/561	383/513	264/354	400	500	360	450	248	310



General Engine Data

Type	4 Cycle, In-line, Turbo Charged, Air Cooled
Bore mm	137 mm (5.39 in.)
Stroke mm	169 mm (6.65 in.)
Displacement Litre	15 litre (912 in. ³)
Cylinder Block	Cast iron, 6 cylinder
Battery Charging Alternator	35 amps
Starting Voltage	24 volt
Fuel System	Direct injection
Fuel Filter	Spin-on fuel filters with water separator
Lube Oil Filter Type(s)	Spin-on full flow filter
Lube Oil Capacity (l)	91.0
Flywheel Dimensions	SAE1

Coolpac Performance Data

Cooling System Design	Air-Air Charge Cooled
Coolant Ratio	50% ethylene glycol; 50% water
Coolant Capacity (l)	42.0
Limiting Ambient Temp.** (°C)	55
Fan Power (kWm)	16
Cooling System Air Flow (m ³ /s)**	11.8
Air Cleaner Type	Light duty dry replaceable element with restriction indicator

** @ 13 mm H₂O Duct Restriction

Weight & Dimensions

Length	Width	Height	Weight (dry)
mm	mm	mm	kg
2269	1332	1669	1658

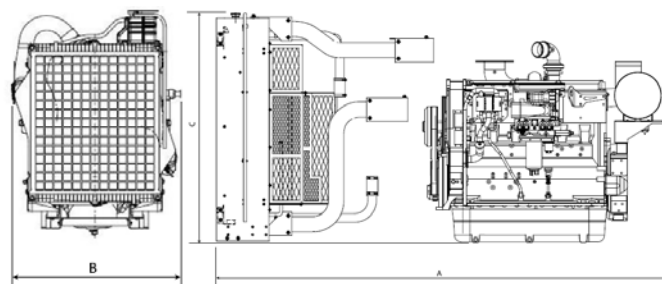

Fuel Consumption 1500 (50 Hz)

%	kWm	BHP	L/ph	US gal/ph
Standby Power				
100	500	670	123.0	32.4
Prime Power				
100	444	595	103.0	27.3
75	333	447	78.7	20.8
50	222	298	54.7	14.5
25	111	149	30.3	8
Continuous Power				
100	317	425	75.7	20

Fuel Consumption 1800 (60 Hz)

%	kWm	BHP	L/ph	US gal/ph
Standby Power				
100	455	610	107.0	28.4
Prime Power				
100	414	555	97.6	25.8
75	311	416	75.2	19.9
50	207	278	53.4	14.1
25	104	139	31.8	8.4
Continuous Power				
100	295	395	72.7	19.1

Cummins G-Drive Engines

Asia Pacific

10 Toh Guan Road
#07-01
TT International Tradepark
Singapore 608838
Phone 65 6417 2388
Fax 65 6417 2399

Europe, CIS, Middle

East and Africa
Manston Park Columbus Ave
Manston Ramsgate
Kent CT12 5BF. UK
Phone 44 1843 255000
Fax 44 1843 255902

Latin America

Rua Jati, 310, Cumbica
Guarulhos, SP 07180-900
Brazil
Phone 55 11 2186 4552
Fax 55 11 2186 4729

Mexico

Cummins S. de R.L. de C.V.
Eje 122 No. 200 Zona Industrial
San Luis Potosi, S.L.P. 78090
Mexico
Phone 52 444 870 6700
Fax 52 444 870 6811

North America

1400 73rd Avenue N.E.
Minneapolis, MN 55432
USA
Phone 1 763 574 5000
USA Toll-free 1 877 769 7669
Fax 1 763 574 5298

Ratings Definitions

Emergency Standby Power (ESP):

Applicable for supplying power to varying electrical load for the duration of power interruption of a reliable utility source. Emergency Standby Power (ESP) is in accordance with ISO 8528. Fuel Stop power in accordance with ISO 3046, AS 2789, DIN 6271 and BS 5514.

Limited-Time Running Power (LTP):

Applicable for supplying power to a constant electrical load for limited hours. Limited-Time Running Power (LTP) is in accordance with ISO 8528.

Prime Power (PRP):

Applicable for supplying power to varying electrical load for unlimited hours. Prime Power (PRP) is in accordance with ISO 8528. Ten percent overload capability is available in accordance with ISO 3046, AS 2789, DIN 6271 and BS 5514.

Base Load (Continuous) Power (COP):

Applicable for supplying power continuously to a constant electrical load for unlimited hours. Continuous Power (COP) is in accordance with ISO 8528, ISO 3046, AS 2789, DIN6271 and BS 5514.





HCI 534C/544C - Technical Data Sheet

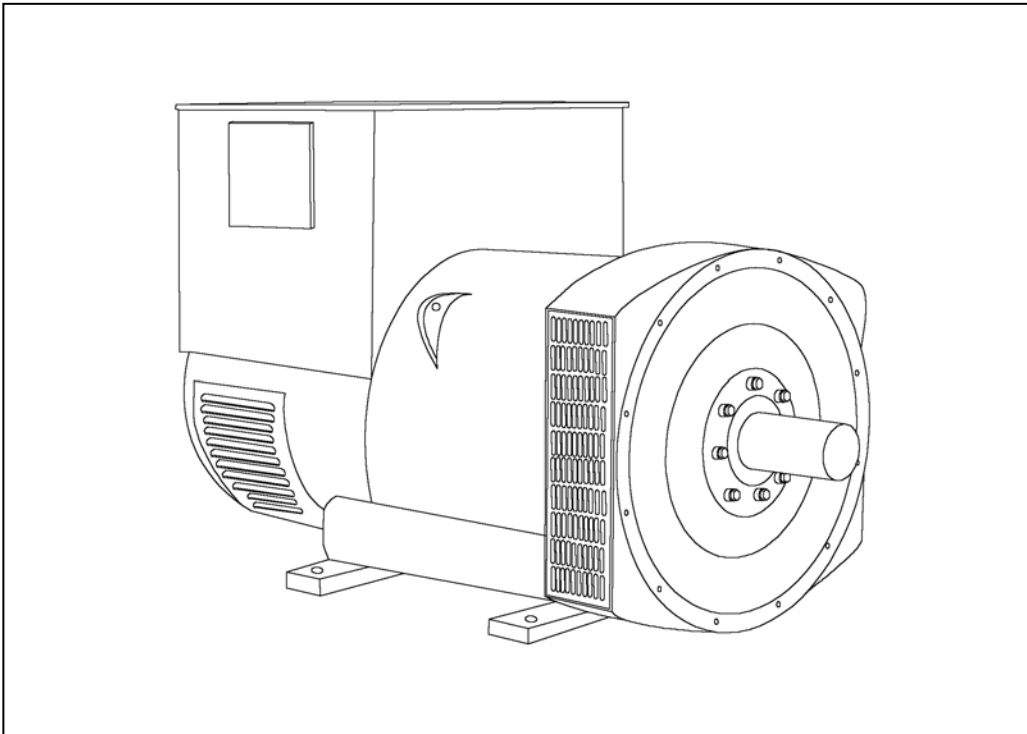

HCI534C/544C

SPECIFICATIONS & OPTIONS



STANDARDS

Newage Stamford industrial generators meet the requirements of BS EN 60034 and the relevant section of other international standards such as BS5000, VDE 0530, NEMA MG1-32, IEC34, CSA C22.2-100, AS1359. Other standards and certifications can be considered on request.

VOLTAGE REGULATORS

SX440 AVR - STANDARD

With this self-excited system the main stator provides power via the Automatic Voltage Regulator (AVR) to the exciter stator. The high efficiency semi-conductors of the AVR ensure positive build-up from initial low levels of residual voltage.

The exciter rotor output is fed to the main rotor through a three-phase full-wave bridge rectifier. The rectifier is protected by a surge suppressor against surges caused, for example, by short circuit or out-of-phase paralleling.

The SX440 will support a range of electronic accessories, including a 'droop' Current Transformer (CT) to permit parallel operation with other ac generators.

If 3-phase sensing is required with the self-excited system, the SX421 AVR must be used.

SX421 AVR

This AVR also operates in a self-excited system. It combines all the features of the SX440 with, additionally, three-phase rms sensing for improved regulation and performance. Over voltage protection is provided via a separate circuit breaker. An engine relief load acceptance feature is built in as standard.

MX341 AVR

This sophisticated AVR is incorporated into the Stamford Permanent Magnet Generator (PMG) control system.

The PMG provides power via the AVR to the main exciter, giving a source of constant excitation power independent of generator output. The main exciter output is then fed to the main rotor, through a full wave bridge, protected by a surge suppressor. The AVR has in-built protection against sustained over-excitation, caused by internal or external faults. This de-excites the machine after a minimum of 5 seconds.

An engine relief load acceptance feature can enable full load to be applied to the generator in a single step.

If three-phase sensing is required with the PMG system the MX321 AVR must be used.

We recommend three-phase sensing for applications with greatly unbalanced or highly non-linear loads.

MX321 AVR

The most sophisticated of all our AVRs combines all the features of the MX341 with, additionally, three-phase rms sensing, for improved regulation and performance.

Over voltage protection is built-in and short circuit current level adjustments is an optional facility.

WINDINGS & ELECTRICAL PERFORMANCE

All generator stators are wound to 2/3 pitch. This eliminates triplen (3rd, 9th, 15th ...) harmonics on the voltage waveform and is found to be the optimum design for trouble-free supply of non-linear loads. The 2/3 pitch design avoids excessive neutral currents sometimes seen with higher winding pitches, when in parallel with the mains. A fully connected damper winding reduces oscillations during paralleling. This winding, with the 2/3 pitch and carefully selected pole and tooth designs, ensures very low waveform distortion.

TERMINALS & TERMINAL BOX

Standard generators are 3-phase reconnectable with 12 ends brought out to the terminals, which are mounted on a cover at the non-drive end of the generator. A sheet steel terminal box contains the AVR and provides ample space for the customers' wiring and gland arrangements. It has removable panels for easy access.

SHAFT & KEYS

All generator rotors are dynamically balanced to better than BS6861:Part 1 Grade 2.5 for minimum vibration in operation. Two bearing generators are balanced with a half key.

INSULATION/IMPREGNATION

The insulation system is class 'H'.

All wound components are impregnated with materials and processes designed specifically to provide the high build required for static windings and the high mechanical strength required for rotating components.

QUALITY ASSURANCE

Generators are manufactured using production procedures having a quality assurance level to BS EN ISO 9001.

The stated voltage regulation may not be maintained in the presence of certain radio transmitted signals. Any change in performance will fall within the limits of Criteria 'B' of EN 61000-6-2:2001. At no time will the steady-state voltage regulation exceed 2%.

NB Continuous development of our products entitles us to change specification details without notice, therefore they must not be regarded as binding.

Front cover drawing typical of product range.

HCI534C/544C

WINDING 311

CONTROL SYSTEM	SEPARATELY EXCITED BY P.M.G.							
A.V.R.	MX321	MX341						
VOLTAGE REGULATION	± 0.5 %	± 1.0 %	With 4% ENGINE GOVERNING					
SUSTAINED SHORT CIRCUIT	REFER TO SHORT CIRCUIT DECREMENT CURVES (page 7)							
CONTROL SYSTEM	SELF EXCITED							
A.V.R.	SX440	SX421						
VOLTAGE REGULATION	± 1.0 %	± 0.5 %	With 4% ENGINE GOVERNING					
SUSTAINED SHORT CIRCUIT	SERIES 4 CONTROL DOES NOT SUSTAIN A SHORT CIRCUIT CURRENT							
INSULATION SYSTEM	CLASS H							
PROTECTION	IP23							
RATED POWER FACTOR	0.8							
STATOR WINDING	DOUBLE LAYER LAP							
WINDING PITCH	TWO THIRDS							
WINDING LEADS	12							
STATOR WDG. RESISTANCE	0.0065 Ohms PER PHASE AT 22°C SERIES STAR CONNECTED							
ROTOR WDG. RESISTANCE	1.55 Ohms at 22°C							
R.F.I. SUPPRESSION	BS EN 61000-6-2 & BS EN 61000-6-4,VDE 0875G, VDE 0875N. refer to factory for others							
WAVEFORM DISTORTION	NO LOAD < 1.5% NON-DISTORTING BALANCED LINEAR LOAD < 5.0%							
MAXIMUM OVERSPEED	2250 Rev/Min							
BEARING DRIVE END	BALL. 6220 (ISO)							
BEARING NON-DRIVE END	BALL. 6314 (ISO)							
	1 BEARING				2 BEARING			
WEIGHT COMP. GENERATOR	1263 kg				1275 kg			
WEIGHT WOUND STATOR	584 kg				584 kg			
WEIGHT WOUND ROTOR	502 kg				473 kg			
WR ² INERTIA	6.8928 kgm ²				6.6149 kgm ²			
SHIPPING WEIGHTS in a crate	1355 kg				1395 kg			
PACKING CRATE SIZE	166 x 87 x 124(cm)				166 x 87 x 124(cm)			
	50 Hz				60 Hz			
TELEPHONE INTERFERENCE	THF<2%				TIF<50			
COOLING AIR	1.035 m ³ /sec 2202 cfm				1.312 m ³ /sec 2780 cfm			
VOLTAGE SERIES STAR	380/220	400/231	415/240	440/254	416/240	440/254	460/266	480/277
VOLTAGE PARALLEL STAR	190/110	200/115	208/120	220/127	208/120	220/127	230/133	240/138
VOLTAGE SERIES DELTA	220/110	230/115	240/120	254/127	240/120	254/127	266/133	277/138
KVA BASE RATING FOR REACTANCE VALUES	450	450	450	450	525	550	581	594
X _d DIR. AXIS SYNCHRONOUS	3.27	2.95	2.74	2.44	3.94	3.69	3.57	3.35
X' _d DIR. AXIS TRANSIENT	0.18	0.16	0.15	0.13	0.18	0.17	0.16	0.15
X'' _d DIR. AXIS SUBTRANSIENT	0.13	0.12	0.11	0.10	0.13	0.12	0.12	0.11
X _q QUAD. AXIS REACTANCE	2.66	2.40	2.23	1.98	3.12	2.92	2.82	2.65
X'' _q QUAD. AXIS SUBTRANSIENT	0.26	0.24	0.22	0.20	0.34	0.32	0.31	0.29
X _L LEAKAGE REACTANCE	0.07	0.06	0.06	0.05	0.08	0.07	0.07	0.07
X ₂ NEGATIVE SEQUENCE	0.19	0.17	0.16	0.14	0.23	0.22	0.21	0.20
X ₀ ZERO SEQUENCE	0.11	0.10	0.09	0.08	0.11	0.10	0.10	0.09
REACTANCES ARE SATURATED VALUES ARE PER UNIT AT RATING AND VOLTAGE INDICATED								
T' _d TRANSIENT TIME CONST.	0.08s							
T'' _d SUB-TRANSTIME CONST.	0.012s							
T' _{do} O.C. FIELD TIME CONST.	2s							
T _a ARMATURE TIME CONST.	0.017s							
SHORT CIRCUIT RATIO	1/X _d							

**50
Hz**

HCI534C/544C
Winding 311



THREE PHASE EFFICIENCY CURVES

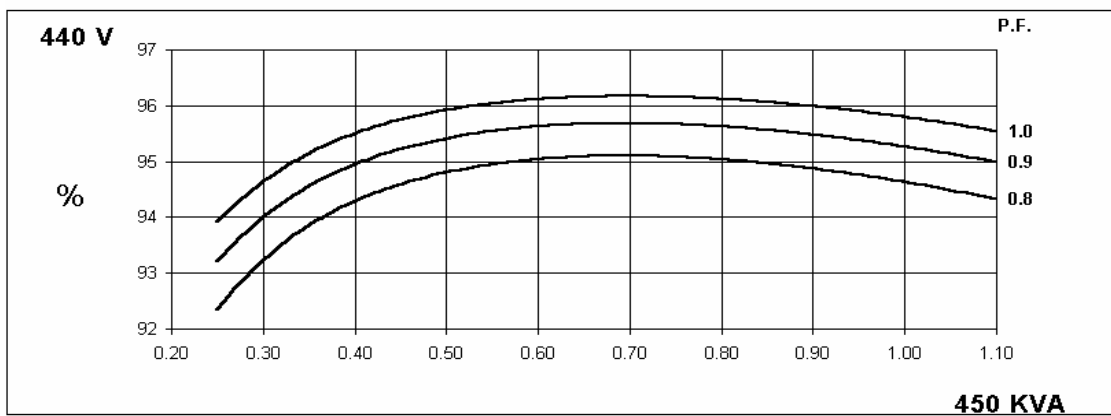
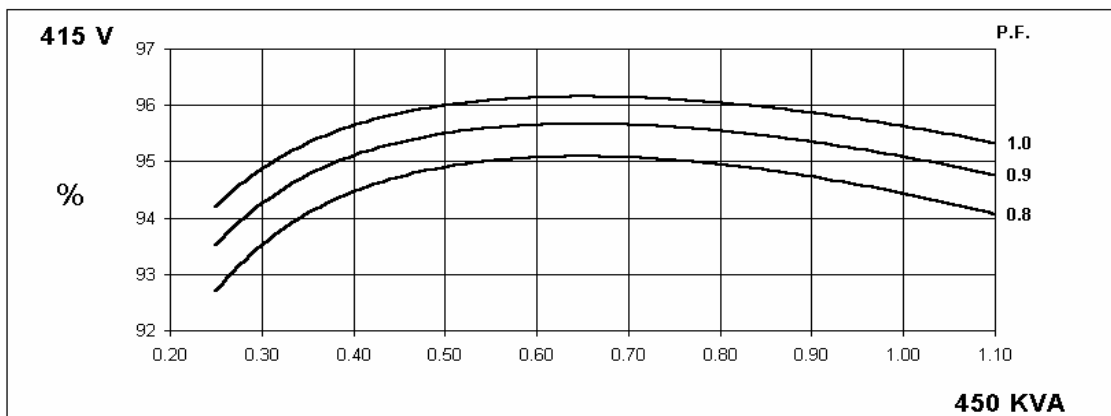
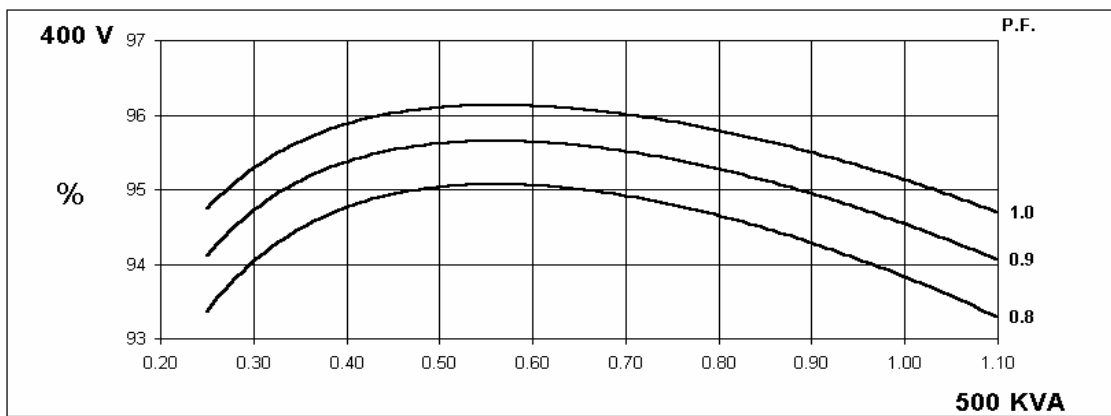
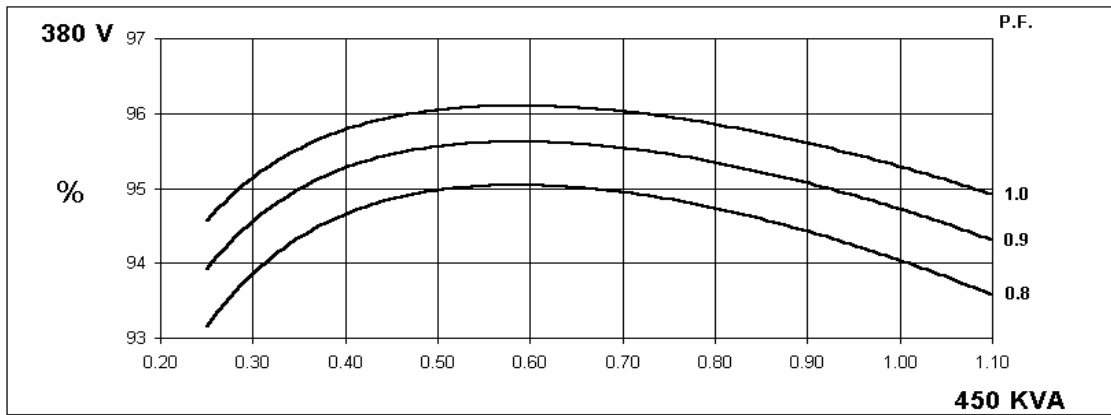

THREE PHASE EFFICIENCY CURVES

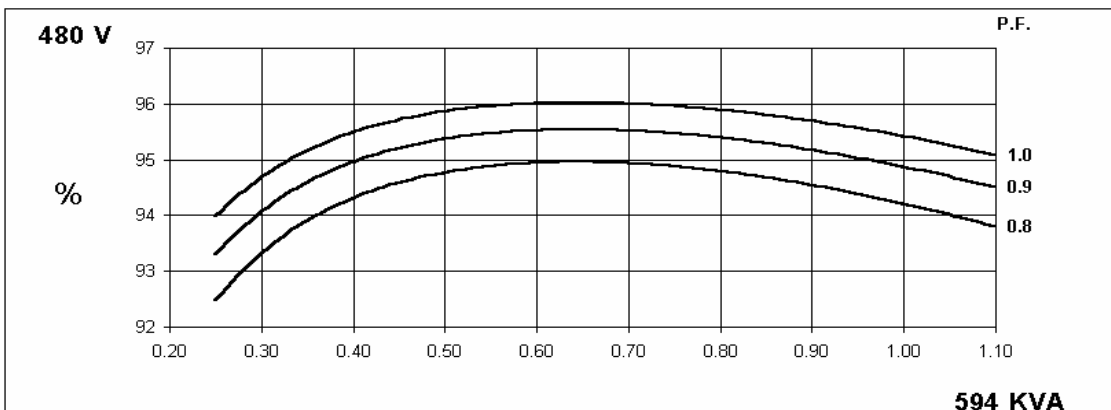
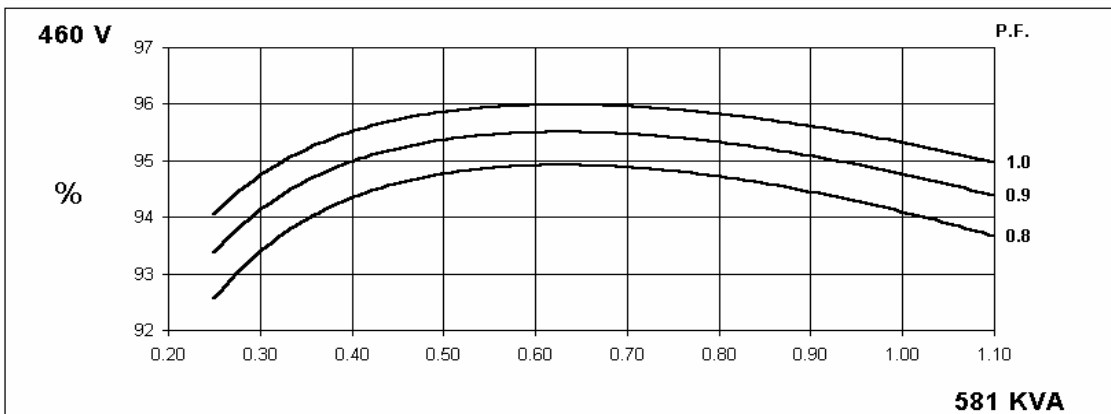
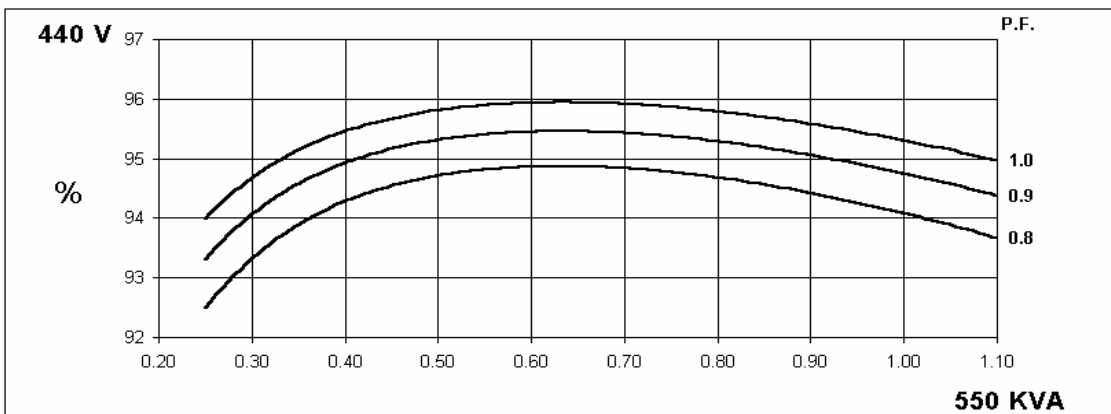
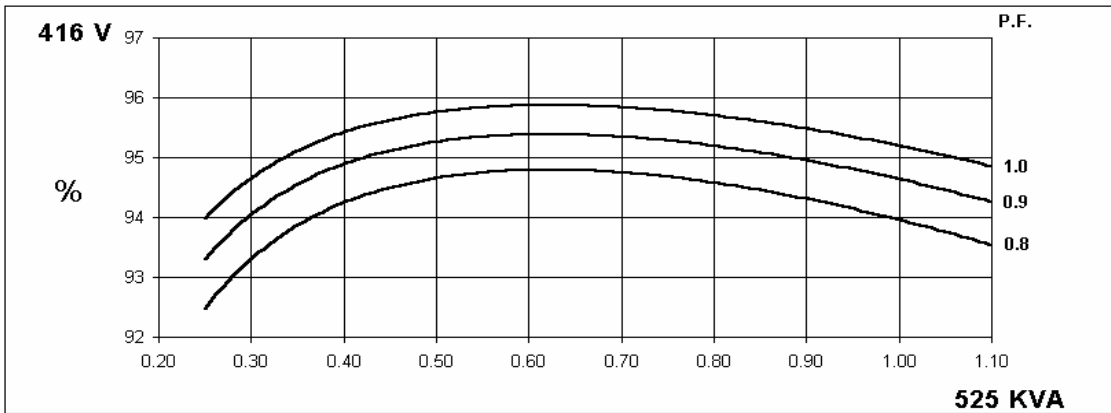

HCI534C/544C

Winding 311



Locked Rotor Motor Starting Curve

**50
Hz**

MX

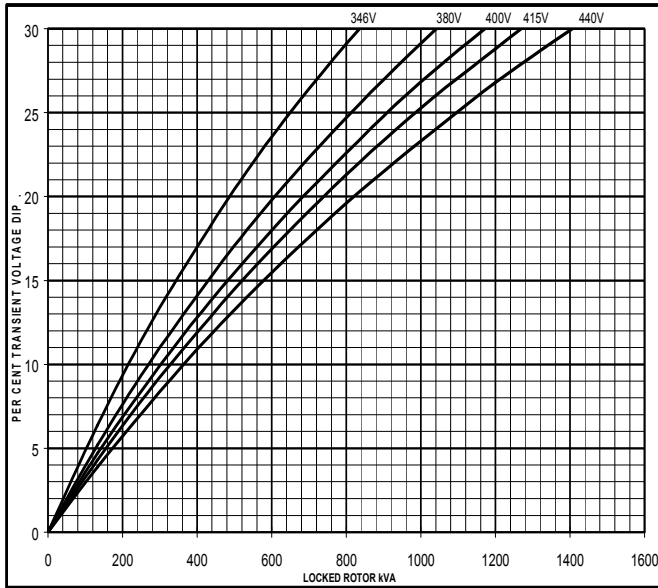

SX

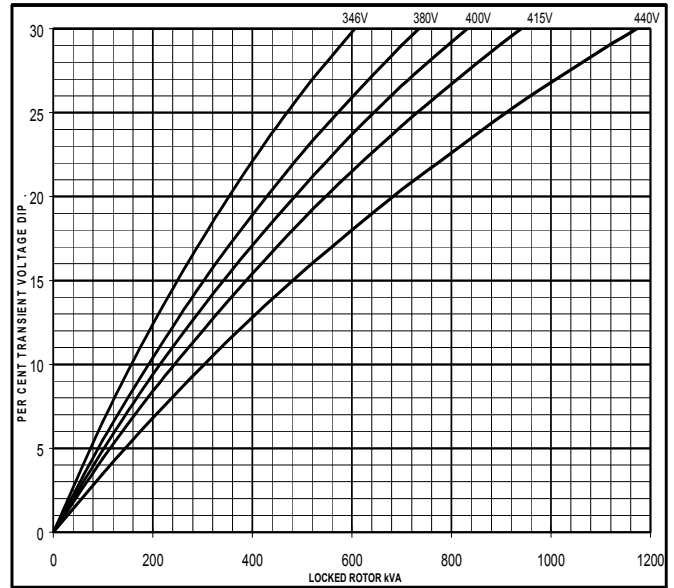

**60
Hz**

MX

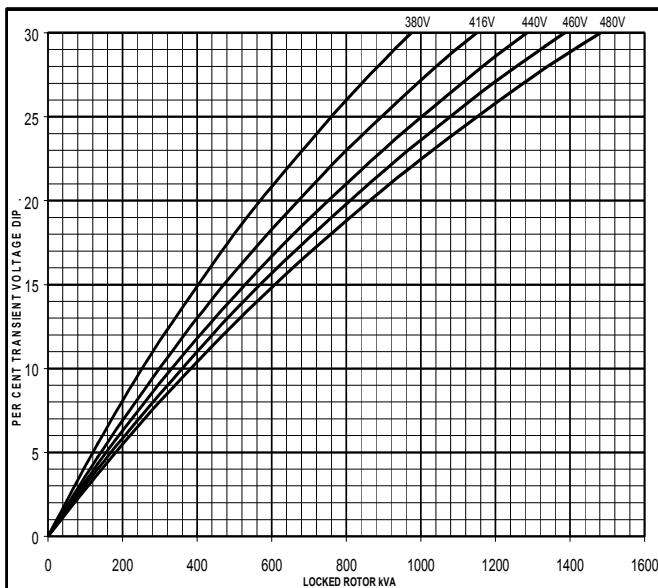

SX

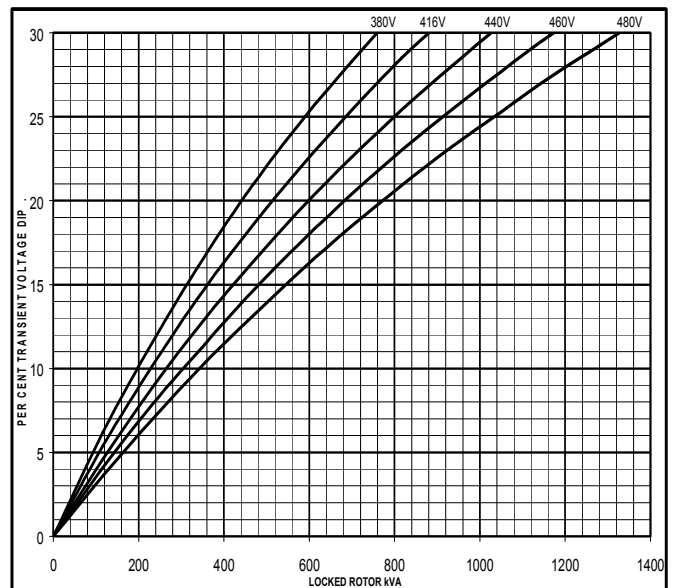

**Three-phase Short Circuit Decrement Curve. No-load Excitation at Rated Speed
Based on star (wye) connection.**

**50
Hz**

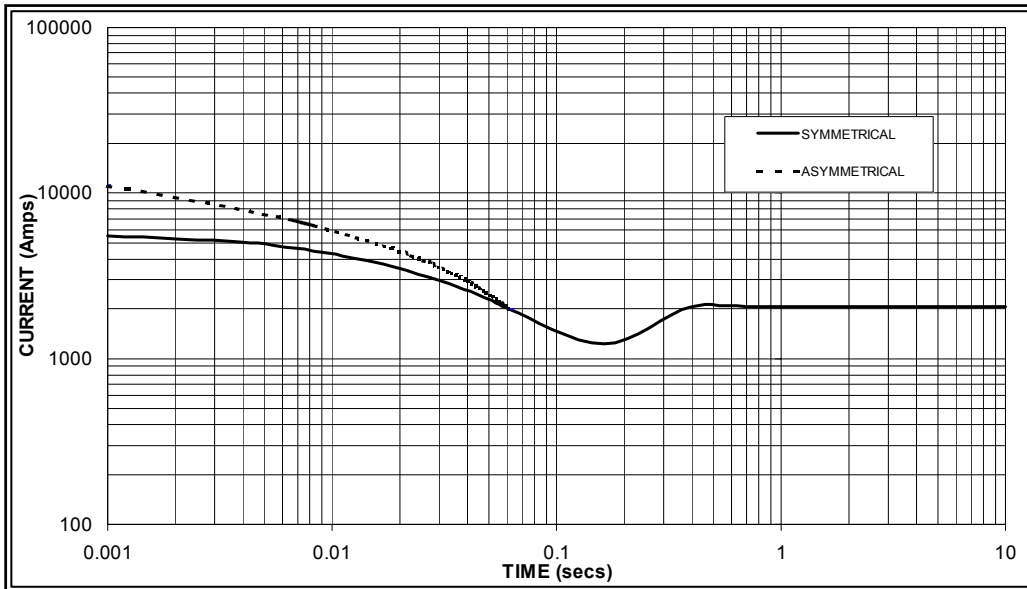

Sustained Short Circuit = 2,050 Amps

**60
Hz**

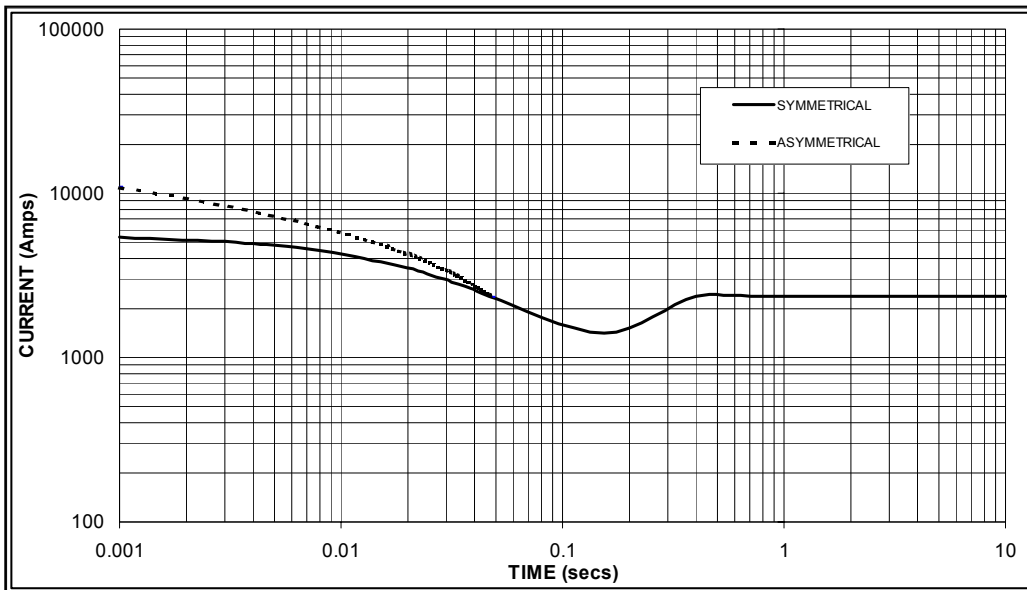

Sustained Short Circuit = 2,350 Amps

Note 1

The following multiplication factors should be used to adjust the values from curve between time 0.001 seconds and the minimum current point in respect of nominal operating voltage :

50Hz		60Hz	
Voltage	Factor	Voltage	Factor
380v	X 1.00	416v	X 1.00
400v	X 1.03	440v	X 1.06
415v	X 1.05	460v	X 1.12
440v	X 1.07	480v	X 1.20

The sustained current value is constant irrespective of voltage level

Note 2

The following multiplication factor should be used to convert the values calculated in accordance with NOTE 1 to those applicable to the various types of short circuit :

	3-phase	2-phase L-L	1-phase L-N
Instantaneous	x 1.00	x 0.87	x 1.30
Minimum	x 1.00	x 1.80	x 3.20
Sustained	x 1.00	x 1.50	x 2.50
Max. sustained duration	10 sec.	5 sec.	2 sec.

All other times are unchanged

Note 3

Curves are drawn for Star (Wye) connected machines. For other connection the following multipliers should be applied to current values as shown :

Parallel Star = Curve current value X 2

Series Delta = Curve current value X 1.732

HCI534C/544C

Winding 311 0.8 Power Factor



RATINGS

Class - Temp Rise	Cont. F - 105/40°C				Cont. H - 125/40°C				Standby - 150/40°C				Standby - 163/27°C				
50 Hz	Series Star (V)	380	400	415	440	380	400	415	440	380	400	415	440	380	400	415	440
	Parallel Star (V)	190	200	208	220	190	200	208	220	190	200	208	220	190	200	208	220
	Series Delta (V)	220	230	240	254	220	230	240	254	220	230	240	254	220	230	240	254
	kVA	400	445	400	400	450	500	450	450	478	512	478	478	495	520	495	495
	kW	320	356	320	320	360	400	360	360	382	410	382	382	396	416	396	396
	Efficiency (%)	94.5	94.3	94.8	94.9	94.0	93.8	94.4	94.6	93.8	93.7	94.2	94.4	93.6	93.6	94.1	94.3
	kW Input	339	378	338	337	383	426	381	381	408	437	406	405	423	444	421	420

60 Hz	Series Star (V)	416	440	460	480	416	440	460	480	416	440	460	480	416	440	460	480
	Parallel Star (V)	208	220	230	240	208	220	230	240	208	220	230	240	208	220	230	240
	Delta (V)	240	254	266	277	240	254	266	277	240	254	266	277	240	254	266	277
	kVA	481	500	531	538	525	550	581	594	550	581	613	625	569	600	631	644
	kW	385	400	425	430	420	440	465	475	440	465	490	500	455	480	505	515
	Efficiency (%)	94.3	94.4	94.4	94.5	94.0	94.1	94.1	94.2	93.8	93.9	93.9	94.0	93.6	93.7	93.7	93.9
	kW Input	408	424	450	455	447	468	494	504	469	495	522	532	486	512	539	549

DIMENSIONS

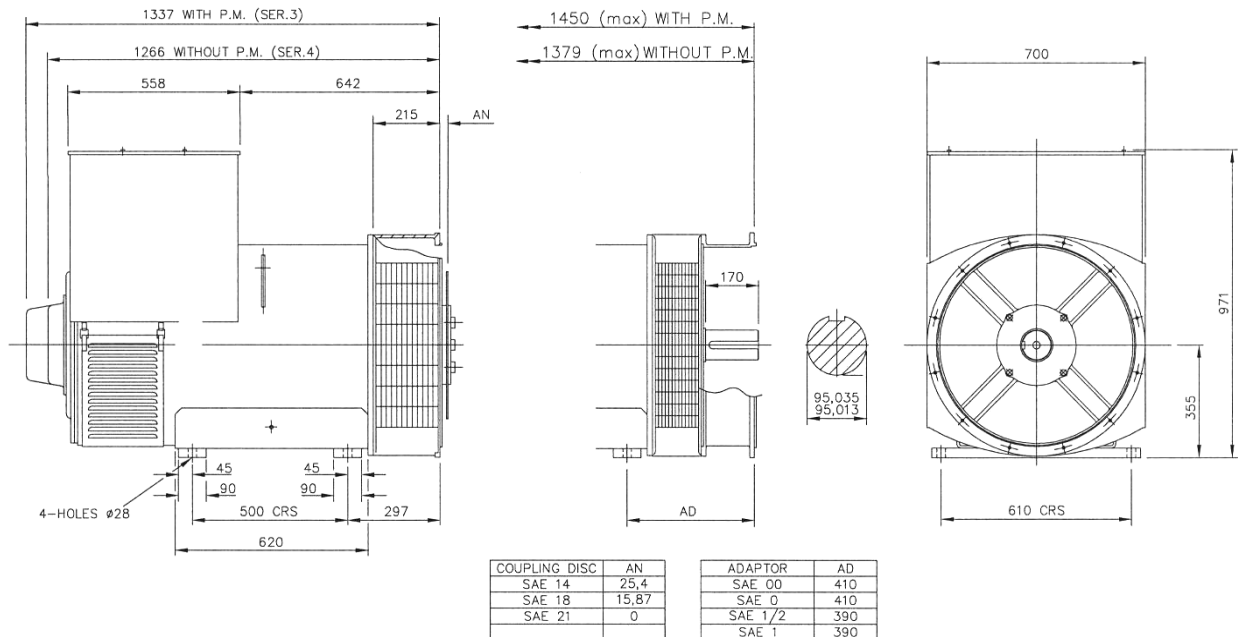

PO Box 17 • Barnack Road • Stamford • Lincolnshire • PE9 2NB
Tel: 00 44 (0)1780 484000 • Fax: 00 44 (0)1780 484100

QSX15-G6

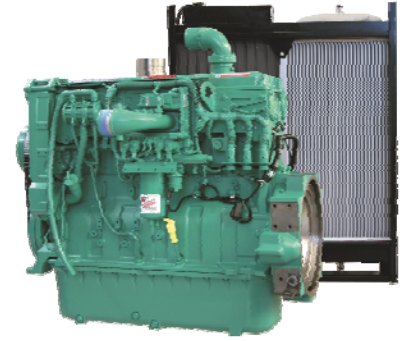

Emissions Compliance:

Non-Certified or "Flex" program for EU Mobile applications.
Formerly EU Stage2 @ 50Hz.

> Specification sheet



Our energy working for you.™

Description

The QSX15-Series is the first heavy-duty diesel with 24-valve dual overhead camshaft technology. Yet it has an impressive 30% fewer parts than comparable diesels and a utilised design, which eliminates external lube, coolant and fuel lines, leading to higher reliability for such a high power output.

The 15 litre, six-cylinder QSX15 engine is ideally suited to both open and containerised applications in static or portable genset equipment. It can be matched to meet specific duty cycle and operating conditions of any genset.



This engine has been built to comply with CE certification.



This engine has been designed in facilities certified to ISO9001 and manufactured in facilities certified to ISO9001 or ISO9002.

Features

Holset HX82 Turbocharging - Wastegated design optimizes operation across the torque curve with improved response.

Integrated Block Design - Integrated fluid circuits replace hoses and eliminate potential leaks.

High-Pressure Fuel Injection - Capable of over 1,900 bar (28,000 psi) for cleaner, more fuel-efficient combustion.

24-Valve Cylinder Head – Four valves per cylinder for increased power with faster response at every rpm.

Coolpac Integrated Design - Products are supplied complete with cooling package and air cleaner kit for a complete power package. Each component has been specifically developed and rigorously tested for G-Drive products, ensuring high performance, durability and reliability.

Service and Support - G-Drive products are backed by an uncompromising level of technical support and after sales service, delivered through a world class service network.

1500 rpm (50 Hz Ratings)

Gross Engine Output			Net Engine Output			Typical Generator Set Output					
Standby	Prime	Base	Standby	Prime	Base	Standby (ESP)		Prime (PRP)		Base (COP)	
kWm/BHP			kWm/BHP			kWe	kVA	kWe	kVA	kWe	kVA
459/616	414/555	291/390	436/584	396/531	273/366	400	500	364	455	256	320

1800 rpm (60 Hz Ratings)

Gross Engine Output			Net Engine Output			Typical Generator Set Output					
Standby	Prime	Base	Standby	Prime	Base	Standby (ESP)		Prime (PRP)		Base (COP)	
kWm/BHP			kWm/BHP			kWe	kVA	kWe	kVA	kWe	kVA
455/610	414/555	295/396	419/561	383/513	264/354	400	500	360	450	245	307



General Engine Data

Type	4 Cycle, In-line, Turbo Charged, Air Cooled
Bore mm	137 mm (5.39 in.)
Stroke mm	169 mm (6.65 in.)
Displacement Litre	15 litre (912 in. ³)
Cylinder Block	Cast iron, 6 cylinder
Battery Charging Alternator	35 amps
Starting Voltage	24 volt
Fuel System	Direct injection
Fuel Filter	Spin-on fuel filters with water separator
Lube Oil Filter Type(s)	Spin-on full flow filter
Lube Oil Capacity (l)	91.0
Flywheel Dimensions	SAE1

Coolpac Performance Data

Cooling System Design	Air-Air Charge Cooled
Coolant Ratio	50% ethylene glycol; 50% water
Coolant Capacity (l)	42.0
Limiting Ambient Temp.** (°C)	55
Fan Power (kWm)	16
Cooling System Air Flow (m ³ /s)**	11.8
Air Cleaner Type	Light duty dry replaceable element with restriction indicator

** @ 13 mm H₂O Duct Restriction

Weight & Dimensions

Length	Width	Height	Weight (dry)
mm	mm	mm	kg
2269	1332	1669	1658

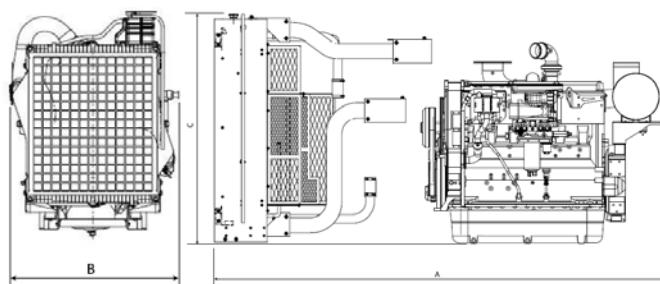

Fuel Consumption 1500 (50 Hz)

%	kWm	BHP	L/ph	US gal/ph
Standby Power				
100	459	615	108.0	28.4
Prime Power				
100	414	555	95.9	25.3
75	311	416	74.3	19.6
50	207	278	51.3	13.6
25	104	139	29.1	7.7
Continuous Power				
100	291	395	71.0	18.7

Fuel Consumption 1800 (60 Hz)

%	kWm	BHP	L/ph	US gal/ph
Standby Power				
100	455	610	107.0	28.4
Prime Power				
100	414	555	97.6	25.8
75	311	416	75.2	19.9
50	207	278	53.4	14.1
25	104	139	31.8	8.4
Continuous Power				
100	295	396	72.7	19.1

Cummins G-Drive Engines

Asia Pacific

10 Toh Guan Road
#07-01
TT International Tradepark
Singapore 608838
Phone 65 6417 2388
Fax 65 6417 2399

Europe, CIS, Middle East and Africa

Manston Park Columbus Ave
Manston Ramsgate
Kent CT12 5BF. UK
Phone 44 1843 255000
Fax 44 1843 255902

Latin America

Rua Jati, 310, Cumbica
Guarulhos, SP 07180-900
Brazil
Phone 55 11 2186 4552
Fax 55 11 2186 4729

Mexico

Cummins S. de R.L. de C.V.
Eje 122 No. 200 Zona Industrial
San Luis Potosí, S.L.P. 78090
Mexico
Phone 52 444 870 6700
Fax 52 444 870 6811

North America

1400 73rd Avenue N.E.
Minneapolis, MN 55432
USA
Phone 1 763 574 5000
USA Toll-free 1 877 769 7669
Fax 1 763 574 5298

Ratings Definitions

Emergency Standby Power (ESP):

Applicable for supplying power to varying electrical load for the duration of power interruption of a reliable utility source. Emergency Standby Power (ESP) is in accordance with ISO 8528. Fuel Stop power in accordance with ISO 3046, AS 2789, DIN 6271 and BS 5514.

Limited-Time Running Power (LTP):

Applicable for supplying power to a constant electrical load for limited hours. Limited-Time Running Power (LTP) is in accordance with ISO 8528.

Prime Power (PRP):

Applicable for supplying power to varying electrical load for unlimited hours. Prime Power (PRP) is in accordance with ISO 8528. Ten percent overload capability is available in accordance with ISO 3046, AS 2789, DIN 6271 and BS 5514.

Base Load (Continuous) Power (COP):

Applicable for supplying power continuously to a constant electrical load for unlimited hours. Continuous Power (COP) is in accordance with ISO 8528, ISO 3046, AS 2789, DIN6271 and BS 5514.



HCI 534C/544C - Technical Data Sheet

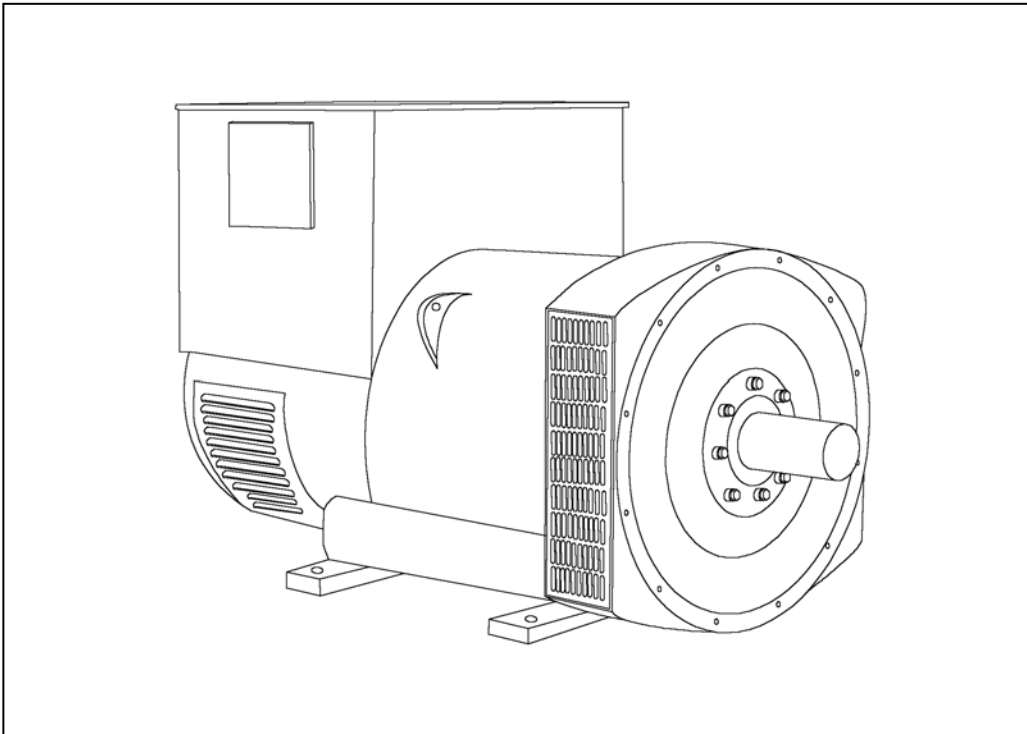

HCI534C/544C

SPECIFICATIONS & OPTIONS



STANDARDS

Newage Stamford industrial generators meet the requirements of BS EN 60034 and the relevant section of other international standards such as BS5000, VDE 0530, NEMA MG1-32, IEC34, CSA C22.2-100, AS1359. Other standards and certifications can be considered on request.

VOLTAGE REGULATORS

SX440 AVR - STANDARD

With this self-excited system the main stator provides power via the Automatic Voltage Regulator (AVR) to the exciter stator. The high efficiency semi-conductors of the AVR ensure positive build-up from initial low levels of residual voltage.

The exciter rotor output is fed to the main rotor through a three-phase full-wave bridge rectifier. The rectifier is protected by a surge suppressor against surges caused, for example, by short circuit or out-of-phase paralleling.

The SX440 will support a range of electronic accessories, including a 'droop' Current Transformer (CT) to permit parallel operation with other ac generators.

If 3-phase sensing is required with the self-excited system, the SX421 AVR must be used.

SX421 AVR

This AVR also operates in a self-excited system. It combines all the features of the SX440 with, additionally, three-phase rms sensing for improved regulation and performance. Over voltage protection is provided via a separate circuit breaker. An engine relief load acceptance feature is built in as standard.

MX341 AVR

This sophisticated AVR is incorporated into the Stamford Permanent Magnet Generator (PMG) control system.

The PMG provides power via the AVR to the main exciter, giving a source of constant excitation power independent of generator output. The main exciter output is then fed to the main rotor, through a full wave bridge, protected by a surge suppressor. The AVR has in-built protection against sustained over-excitation, caused by internal or external faults. This de-excites the machine after a minimum of 5 seconds.

An engine relief load acceptance feature can enable full load to be applied to the generator in a single step.

If three-phase sensing is required with the PMG system the MX321 AVR must be used.

We recommend three-phase sensing for applications with greatly unbalanced or highly non-linear loads.

MX321 AVR

The most sophisticated of all our AVRs combines all the features of the MX341 with, additionally, three-phase rms sensing, for improved regulation and performance.

Over voltage protection is built-in and short circuit current level adjustments is an optional facility.

WINDINGS & ELECTRICAL PERFORMANCE

All generator stators are wound to 2/3 pitch. This eliminates triplen (3rd, 9th, 15th ...) harmonics on the voltage waveform and is found to be the optimum design for trouble-free supply of non-linear loads. The 2/3 pitch design avoids excessive neutral currents sometimes seen with higher winding pitches, when in parallel with the mains. A fully connected damper winding reduces oscillations during paralleling. This winding, with the 2/3 pitch and carefully selected pole and tooth designs, ensures very low waveform distortion.

TERMINALS & TERMINAL BOX

Standard generators are 3-phase reconnectable with 12 ends brought out to the terminals, which are mounted on a cover at the non-drive end of the generator. A sheet steel terminal box contains the AVR and provides ample space for the customers' wiring and gland arrangements. It has removable panels for easy access.

SHAFT & KEYS

All generator rotors are dynamically balanced to better than BS6861:Part 1 Grade 2.5 for minimum vibration in operation. Two bearing generators are balanced with a half key.

INSULATION/IMPREGNATION

The insulation system is class 'H'.

All wound components are impregnated with materials and processes designed specifically to provide the high build required for static windings and the high mechanical strength required for rotating components.

QUALITY ASSURANCE

Generators are manufactured using production procedures having a quality assurance level to BS EN ISO 9001.

The stated voltage regulation may not be maintained in the presence of certain radio transmitted signals. Any change in performance will fall within the limits of Criteria 'B' of EN 61000-6-2:2001. At no time will the steady-state voltage regulation exceed 2%.

NB Continuous development of our products entitles us to change specification details without notice, therefore they must not be regarded as binding.

Front cover drawing typical of product range.

HCI534C/544C

WINDING 311

CONTROL SYSTEM	SEPARATELY EXCITED BY P.M.G.							
A.V.R.	MX321	MX341						
VOLTAGE REGULATION	± 0.5 %	± 1.0 %	With 4% ENGINE GOVERNING					
SUSTAINED SHORT CIRCUIT	REFER TO SHORT CIRCUIT DECREMENT CURVES (page 7)							
CONTROL SYSTEM	SELF EXCITED							
A.V.R.	SX440	SX421						
VOLTAGE REGULATION	± 1.0 %	± 0.5 %	With 4% ENGINE GOVERNING					
SUSTAINED SHORT CIRCUIT	SERIES 4 CONTROL DOES NOT SUSTAIN A SHORT CIRCUIT CURRENT							
INSULATION SYSTEM	CLASS H							
PROTECTION	IP23							
RATED POWER FACTOR	0.8							
STATOR WINDING	DOUBLE LAYER LAP							
WINDING PITCH	TWO THIRDS							
WINDING LEADS	12							
STATOR WDG. RESISTANCE	0.0065 Ohms PER PHASE AT 22°C SERIES STAR CONNECTED							
ROTOR WDG. RESISTANCE	1.55 Ohms at 22°C							
R.F.I. SUPPRESSION	BS EN 61000-6-2 & BS EN 61000-6-4,VDE 0875G, VDE 0875N. refer to factory for others							
WAVEFORM DISTORTION	NO LOAD < 1.5% NON-DISTORTING BALANCED LINEAR LOAD < 5.0%							
MAXIMUM OVERSPEED	2250 Rev/Min							
BEARING DRIVE END	BALL. 6220 (ISO)							
BEARING NON-DRIVE END	BALL. 6314 (ISO)							
	1 BEARING				2 BEARING			
WEIGHT COMP. GENERATOR	1263 kg				1275 kg			
WEIGHT WOUND STATOR	584 kg				584 kg			
WEIGHT WOUND ROTOR	502 kg				473 kg			
WR ² INERTIA	6.8928 kgm ²				6.6149 kgm ²			
SHIPPING WEIGHTS in a crate	1355 kg				1395 kg			
PACKING CRATE SIZE	166 x 87 x 124(cm)				166 x 87 x 124(cm)			
	50 Hz				60 Hz			
TELEPHONE INTERFERENCE	THF<2%				TIF<50			
COOLING AIR	1.035 m ³ /sec 2202 cfm				1.312 m ³ /sec 2780 cfm			
VOLTAGE SERIES STAR	380/220	400/231	415/240	440/254	416/240	440/254	460/266	480/277
VOLTAGE PARALLEL STAR	190/110	200/115	208/120	220/127	208/120	220/127	230/133	240/138
VOLTAGE SERIES DELTA	220/110	230/115	240/120	254/127	240/120	254/127	266/133	277/138
KVA BASE RATING FOR REACTANCE VALUES	450	450	450	450	525	550	581	594
X _d DIR. AXIS SYNCHRONOUS	3.27	2.95	2.74	2.44	3.94	3.69	3.57	3.35
X' _d DIR. AXIS TRANSIENT	0.18	0.16	0.15	0.13	0.18	0.17	0.16	0.15
X'' _d DIR. AXIS SUBTRANSIENT	0.13	0.12	0.11	0.10	0.13	0.12	0.12	0.11
X _q QUAD. AXIS REACTANCE	2.66	2.40	2.23	1.98	3.12	2.92	2.82	2.65
X'' _q QUAD. AXIS SUBTRANSIENT	0.26	0.24	0.22	0.20	0.34	0.32	0.31	0.29
X _L LEAKAGE REACTANCE	0.07	0.06	0.06	0.05	0.08	0.07	0.07	0.07
X ₂ NEGATIVE SEQUENCE	0.19	0.17	0.16	0.14	0.23	0.22	0.21	0.20
X ₀ ZERO SEQUENCE	0.11	0.10	0.09	0.08	0.11	0.10	0.10	0.09
REACTANCES ARE SATURATED VALUES ARE PER UNIT AT RATING AND VOLTAGE INDICATED								
T' _d TRANSIENT TIME CONST.	0.08s							
T'' _d SUB-TRANSTIME CONST.	0.012s							
T' _{do} O.C. FIELD TIME CONST.	2s							
T _a ARMATURE TIME CONST.	0.017s							
SHORT CIRCUIT RATIO	1/X _d							

**50
Hz**

HCI534C/544C
Winding 311



THREE PHASE EFFICIENCY CURVES

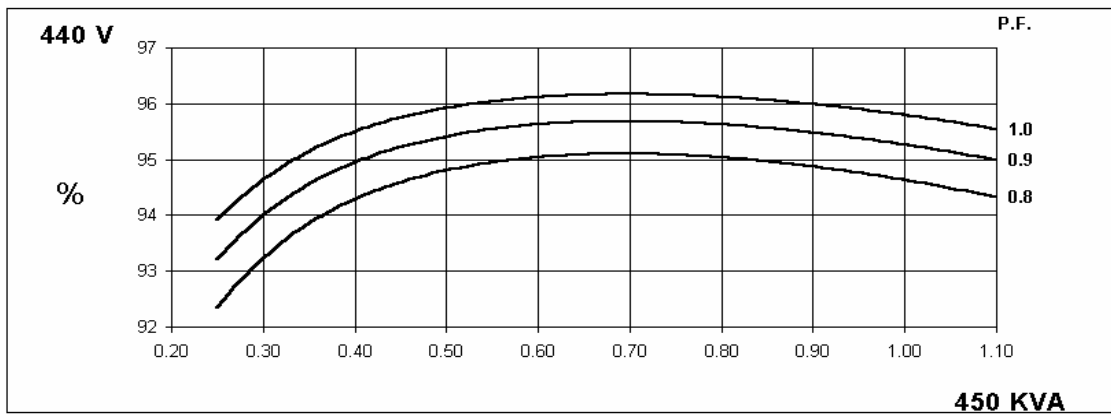
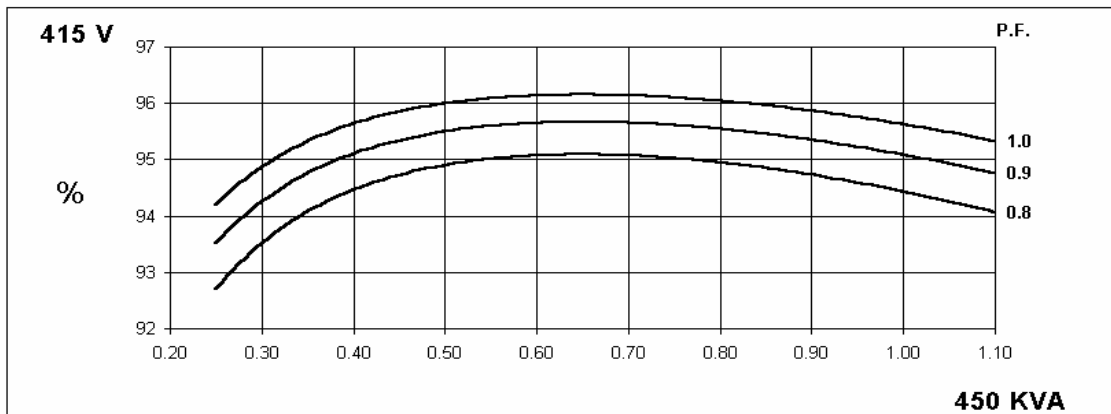
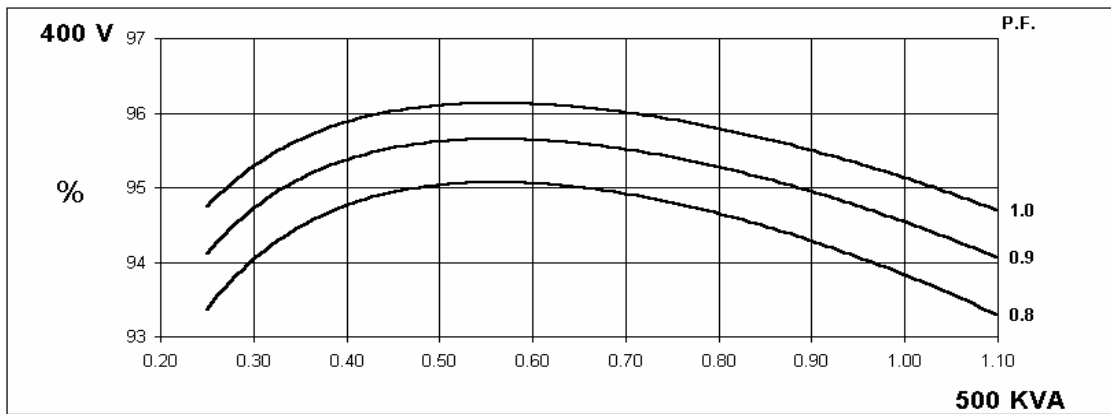
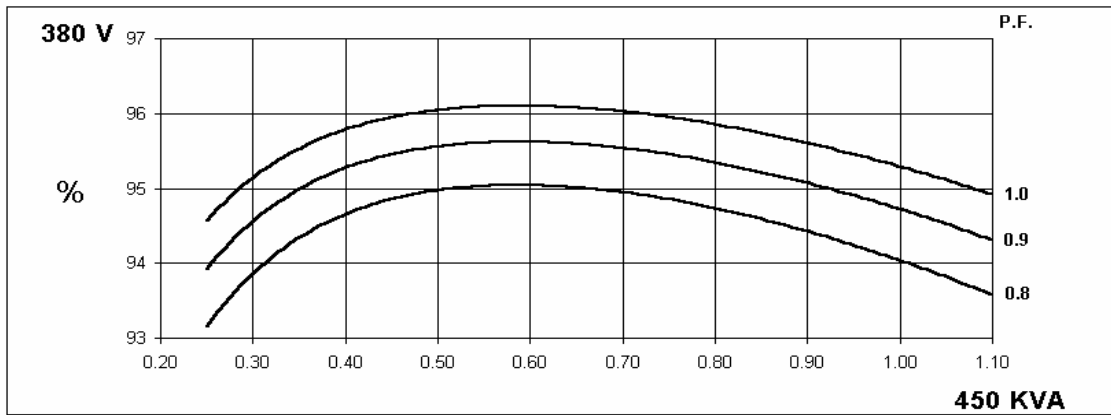

THREE PHASE EFFICIENCY CURVES

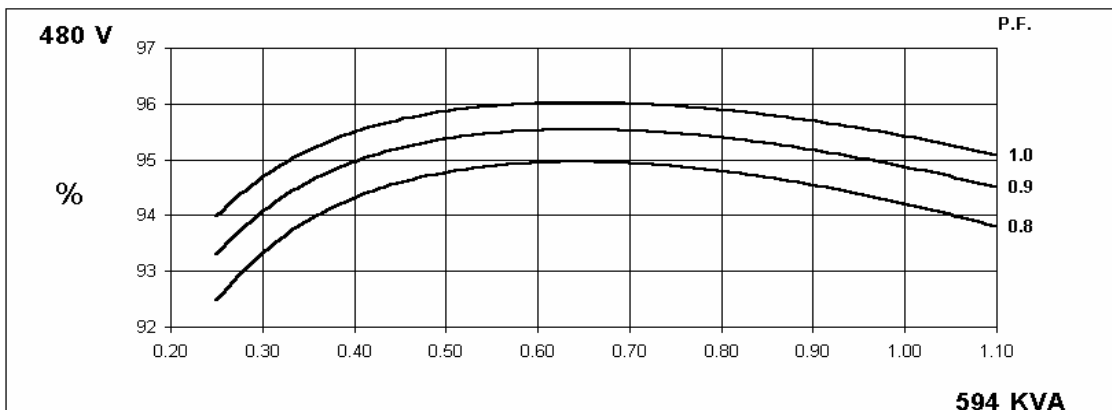
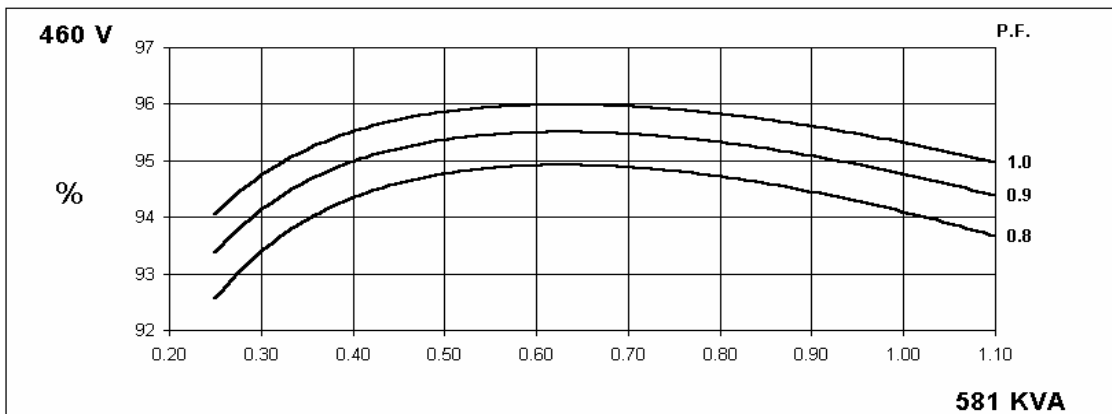
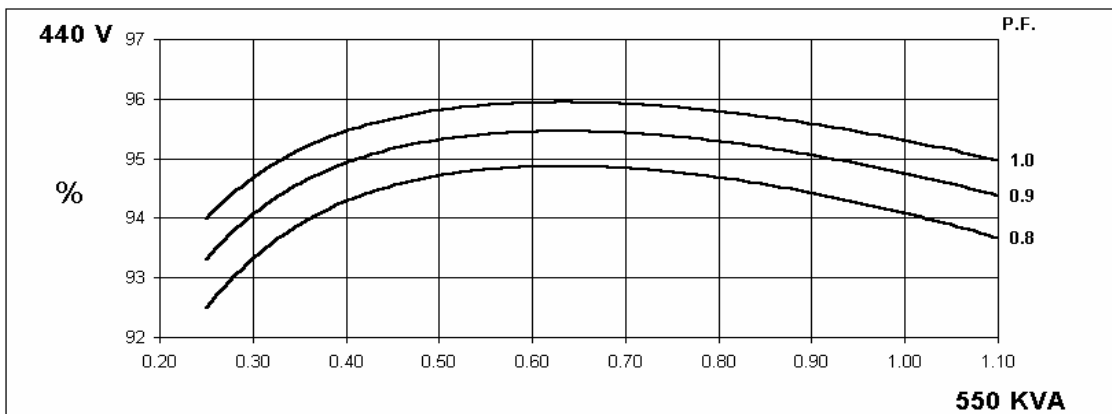
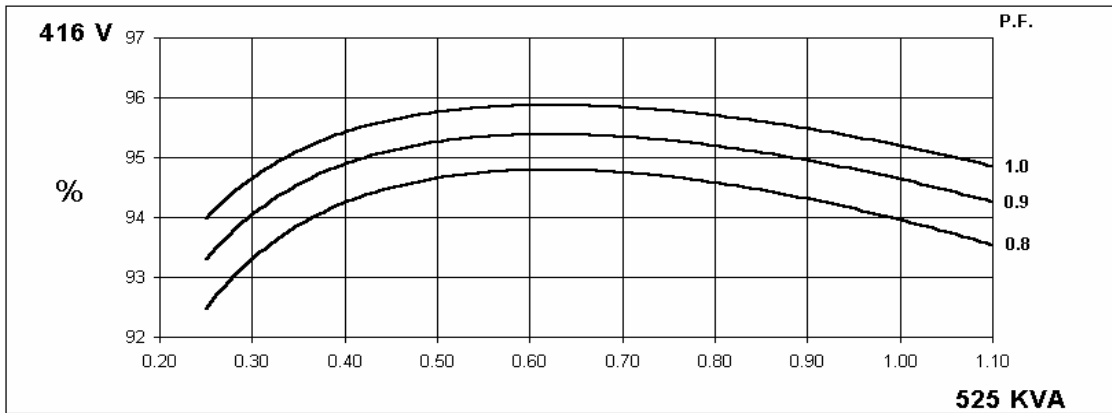

HCI534C/544C

Winding 311



Locked Rotor Motor Starting Curve

**50
Hz**

MX

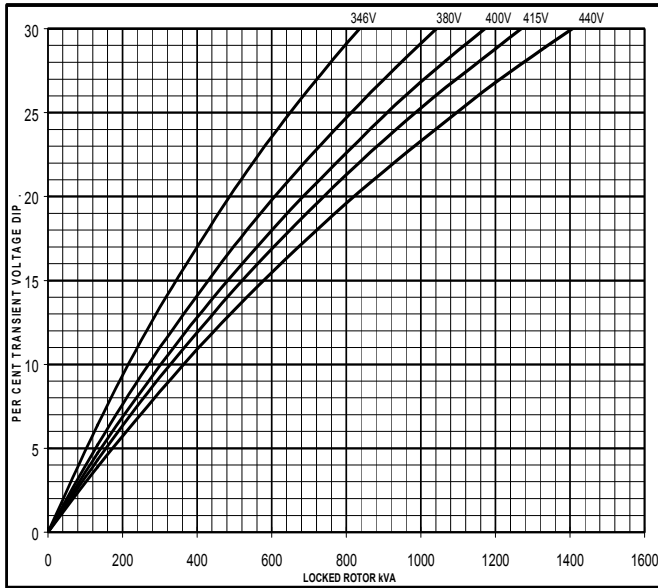

SX

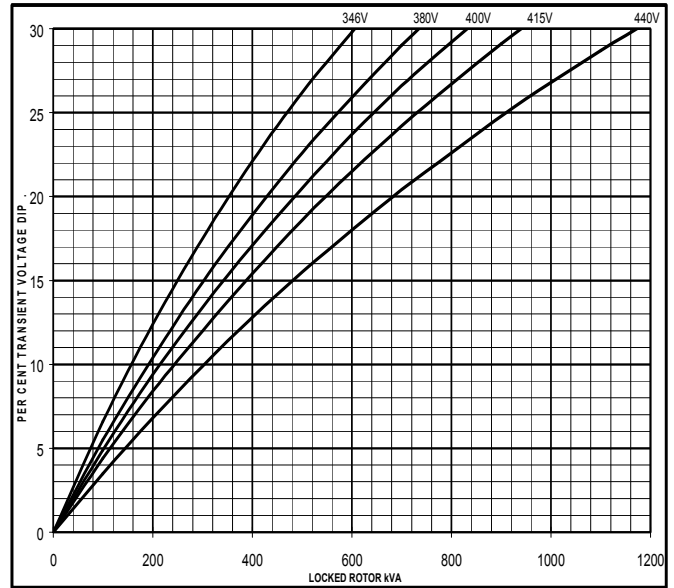

**60
Hz**

MX

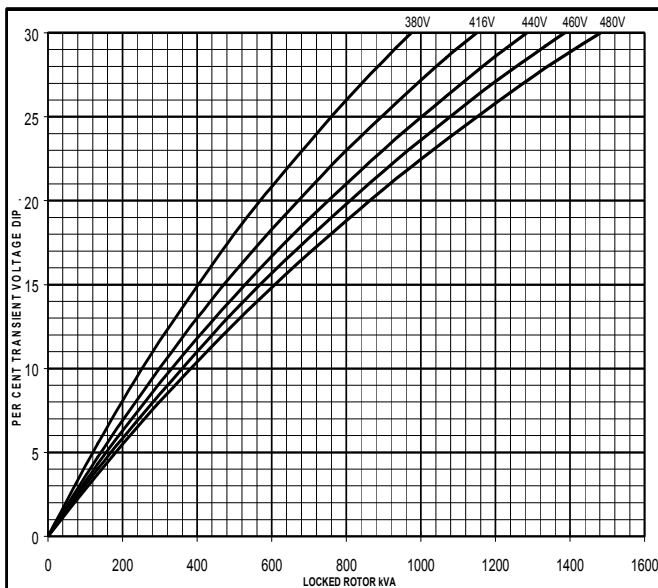

SX

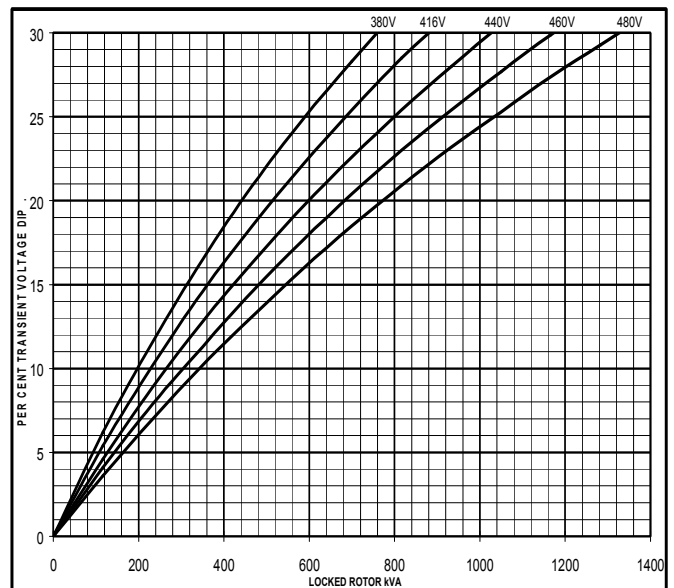

**Three-phase Short Circuit Decrement Curve. No-load Excitation at Rated Speed
Based on star (wye) connection.**

**50
Hz**

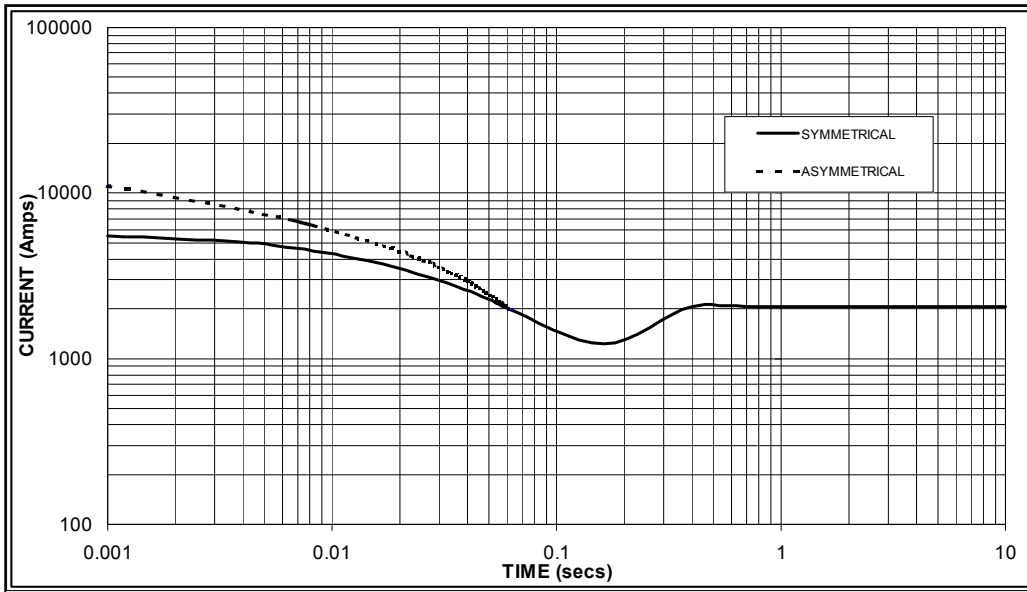

Sustained Short Circuit = 2,050 Amps

**60
Hz**

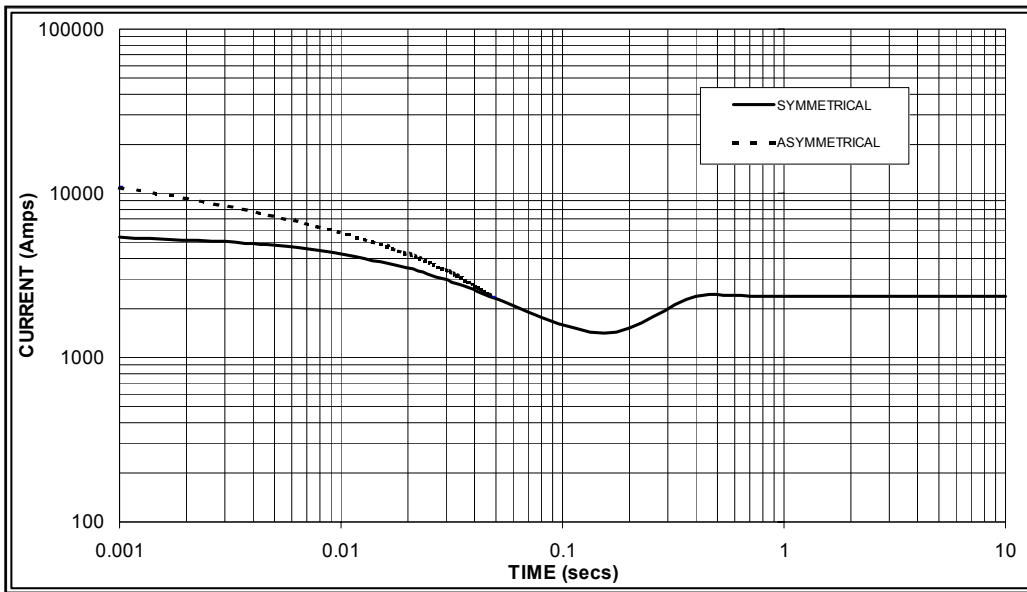

Sustained Short Circuit = 2,350 Amps

Note 1

The following multiplication factors should be used to adjust the values from curve between time 0.001 seconds and the minimum current point in respect of nominal operating voltage :

50Hz		60Hz	
Voltage	Factor	Voltage	Factor
380v	X 1.00	416v	X 1.00
400v	X 1.03	440v	X 1.06
415v	X 1.05	460v	X 1.12
440v	X 1.07	480v	X 1.20

The sustained current value is constant irrespective of voltage level

Note 2

The following multiplication factor should be used to convert the values calculated in accordance with NOTE 1 to those applicable to the various types of short circuit :

	3-phase	2-phase L-L	1-phase L-N
Instantaneous	x 1.00	x 0.87	x 1.30
Minimum	x 1.00	x 1.80	x 3.20
Sustained	x 1.00	x 1.50	x 2.50
Max. sustained duration	10 sec.	5 sec.	2 sec.

All other times are unchanged

Note 3

Curves are drawn for Star (Wye) connected machines. For other connection the following multipliers should be applied to current values as shown :

Parallel Star = Curve current value X 2

Series Delta = Curve current value X 1.732

HCI534C/544C

Winding 311 0.8 Power Factor



RATINGS

Class - Temp Rise	Cont. F - 105/40°C				Cont. H - 125/40°C				Standby - 150/40°C				Standby - 163/27°C				
50 Hz	Series Star (V)	380	400	415	440	380	400	415	440	380	400	415	440	380	400	415	440
	Parallel Star (V)	190	200	208	220	190	200	208	220	190	200	208	220	190	200	208	220
	Series Delta (V)	220	230	240	254	220	230	240	254	220	230	240	254	220	230	240	254
	kVA	400	445	400	400	450	500	450	450	478	512	478	478	495	520	495	495
	kW	320	356	320	320	360	400	360	360	382	410	382	382	396	416	396	396
	Efficiency (%)	94.5	94.3	94.8	94.9	94.0	93.8	94.4	94.6	93.8	93.7	94.2	94.4	93.6	93.6	94.1	94.3
	kW Input	339	378	338	337	383	426	381	381	408	437	406	405	423	444	421	420

60 Hz	Series Star (V)	416	440	460	480	416	440	460	480	416	440	460	480	416	440	460	480
	Parallel Star (V)	208	220	230	240	208	220	230	240	208	220	230	240	208	220	230	240
	Delta (V)	240	254	266	277	240	254	266	277	240	254	266	277	240	254	266	277
	kVA	481	500	531	538	525	550	581	594	550	581	613	625	569	600	631	644
	kW	385	400	425	430	420	440	465	475	440	465	490	500	455	480	505	515
	Efficiency (%)	94.3	94.4	94.4	94.5	94.0	94.1	94.1	94.2	93.8	93.9	93.9	94.0	93.6	93.7	93.7	93.9
	kW Input	408	424	450	455	447	468	494	504	469	495	522	532	486	512	539	549

DIMENSIONS

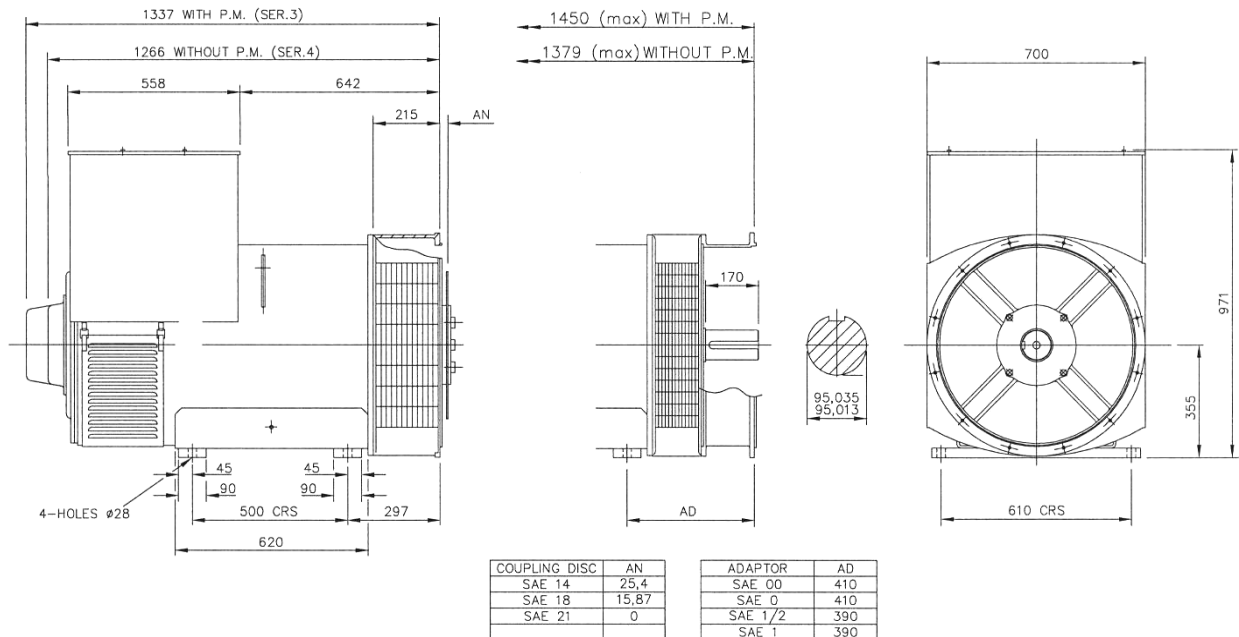

PO Box 17 • Barnack Road • Stamford • Lincolnshire • PE9 2NB
Tel: 00 44 (0)1780 484000 • Fax: 00 44 (0)1780 484100

QSX15-G4

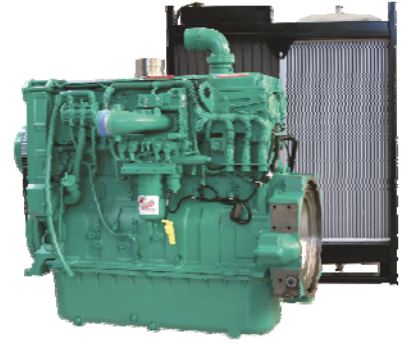

Emissions Compliance:

Non-Certified or "Flex" program for EU Mobile applications.
Formerly EU Stage2 @ 50Hz.

> Specification sheet



Our energy working for you.™

Description

The QSX15-Series is the first heavy-duty diesel with 24-valve dual overhead camshaft technology. Yet it has an impressive 30% fewer parts than comparable diesels and a utilised design, which eliminates external lube, coolant and fuel lines leading to higher reliability for such a high power output.

The 15 litre, six-cylinder QSX15 engine is ideally suited to both open and containerised applications in static or portable genset equipment. It can be matched to meet specific duty cycle and operating conditions of any genset.



This engine has been built to comply with CE certification.



This engine has been designed in facilities certified to ISO9001 and manufactured in facilities certified to ISO9001 or ISO9002.

Features

Holset HX82 Turbocharging - Wastegated design optimizes operation across the torque curve with improved response.

Integrated Block Design - Integrated fluid circuits replace hoses and eliminate potential leaks.

High-Pressure Fuel Injection - Capable of over 1,900 bar (28,000 psi) for cleaner, more fuel-efficient combustion.

24-Valve Cylinder Head – Four valves per cylinder for increased power with faster response at every rpm.

Coolpac Integrated Design - Products are supplied complete with cooling package and air cleaner kit for a complete power package. Each component has been specifically developed and rigorously tested for G-Drive products, ensuring high performance, durability and reliability.

Service and Support - G-Drive products are backed by an uncompromising level of technical support and after sales service, delivered through a world class service network.

1500 rpm (50 Hz Ratings)

Gross Engine Output			Net Engine Output			Typical Generator Set Output					
Standby	Prime	Base	Standby	Prime	Base	Standby (ESP)		Prime (PRP)		Base (COP)	
kWm/BHP			kWm/BHP			kWe	kVA	kWe	kVA	kWe	kVA
407/545	366/490	257/345	385/516	348/466	239/320	360	450	327	409	224	280

1800 rpm (60 Hz Ratings)

Gross Engine Output			Net Engine Output			Typical Generator Set Output					
Standby	Prime	Base	Standby	Prime	Base	Standby (ESP)		Prime (PRP)		Base (COP)	
kWm/BHP			kWm/BHP			kWe	kVA	kWe	kVA	kWe	kVA
455/610	414/555	295/395	419/561	383/514	264/354	400	500	355	445	245	305



General Engine Data

Type	4 Cycle, In-line, Turbo Charged, Air Cooled
Bore mm	137 mm (5.39 in.)
Stroke mm	169 mm (6.65 in.)
Displacement Litre	15 litre (912 in. ³)
Cylinder Block	Cast iron, 6 cylinder
Battery Charging Alternator	35 amps
Starting Voltage	24 volt
Fuel System	Direct injection
Fuel Filter	Spin-on fuel filters with water separator
Lube Oil Filter Type(s)	Spin-on full flow filter
Lube Oil Capacity (l)	91.0
Flywheel Dimensions	SAE1

Coolpac Performance Data

Cooling System Design	Air-Air Charge Cooled
Coolant Ratio	50% ethylene glycol; 50% water
Coolant Capacity (l)	42.0
Limiting Ambient Temp.** (°C)	55
Fan Power (kWm)	16
Cooling System Air Flow (m ³ /s)**	11.8
Air Cleaner Type	Light duty dry replaceable element with restriction indicator

** @ 13 mm H₂O duct Restriction

Weight & Dimensions

Length	Width	Height	Weight (dry)
mm	mm	mm	kg
2269	1332	1669	1658

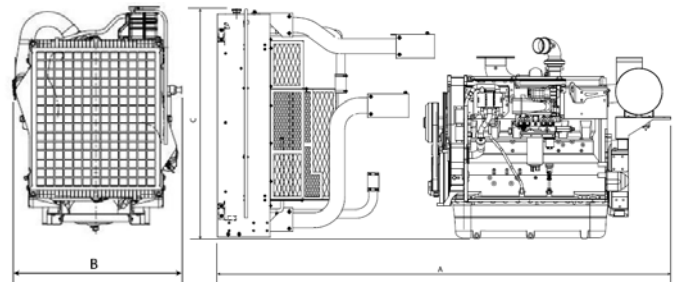

Fuel Consumption 1500 (50 Hz)

%	kWm	BHP	L/ph	US gal/ph
Standby Power				
100	407	545	94.1	24.9
Prime Power				
100	366	490	85.7	22.6
75	275	368	67	17.7
50	183	245	45.7	12.1
25	92	123	26.6	7
Continuous Power				
100	257	345	63.6	16.8

Fuel Consumption 1800 (60 Hz)

%	kWm	BHP	L/ph	US gal/ph
Standby Power				
100	455	610	107.3	28.4
Prime Power				
100	414	555	97.6	25.8
75	311	416	75.2	19.9
50	207	278	53.4	14.1
25	104	139	31.8	8.4
Continuous Power				
100	295	395	72.2	19.1

Cummins G-Drive Engines

Asia Pacific

10 Toh Guan Road
#07-01
TT International Tradepark
Singapore 608838
Phone 65 6417 2388
Fax 65 6417 2399

Europe, CIS, Middle

East and Africa
Manston Park Columbus Ave
Manston Ramsgate
Kent CT12 5BF. UK
Phone 44 1843 255000
Fax 44 1843 255902

Latin America

Rua Jati, 310, Cumbica
Guarulhos, SP 07180-900
Brazil
Phone 55 11 2186 4552
Fax 55 11 2186 4729

Mexico

Cummins S. de R.L. de C.V.
Eje 122 No. 200 Zona Industrial
San Luis Potosi, S.L.P. 78090
Mexico
Phone 52 444 870 6700
Fax 52 444 870 6811

North America

1400 73rd Avenue N.E.
Minneapolis, MN 55432
USA
Phone 1 763 574 5000
USA Toll-free 1 877 769 7669
Fax 1 763 574 5298

Ratings Definitions

Emergency Standby Power (ESP):

Applicable for supplying power to varying electrical load for the duration of power interruption of a reliable utility source. Emergency Standby Power (ESP) is in accordance with ISO 8528. Fuel Stop power in accordance with ISO 3046, AS 2789, DIN 6271 and BS 5514.

Limited-Time Running Power (LTP):

Applicable for supplying power to a constant electrical load for limited hours. Limited-Time Running Power (LTP) is in accordance with ISO 8528.

Prime Power (PRP):

Applicable for supplying power to varying electrical load for unlimited hours. Prime Power (PRP) is in accordance with ISO 8528. Ten percent overload capability is available in accordance with ISO 3046, AS 2789, DIN 6271 and BS 5514.

Base Load (Continuous) Power (COP):

Applicable for supplying power continuously to a constant electrical load for unlimited hours. Continuous Power (COP) is in accordance with ISO 8528, ISO 3046, AS 2789, DIN6271 and BS 5514.





STAMFORD[®]

HCI 434F/444F - Technical Data Sheet

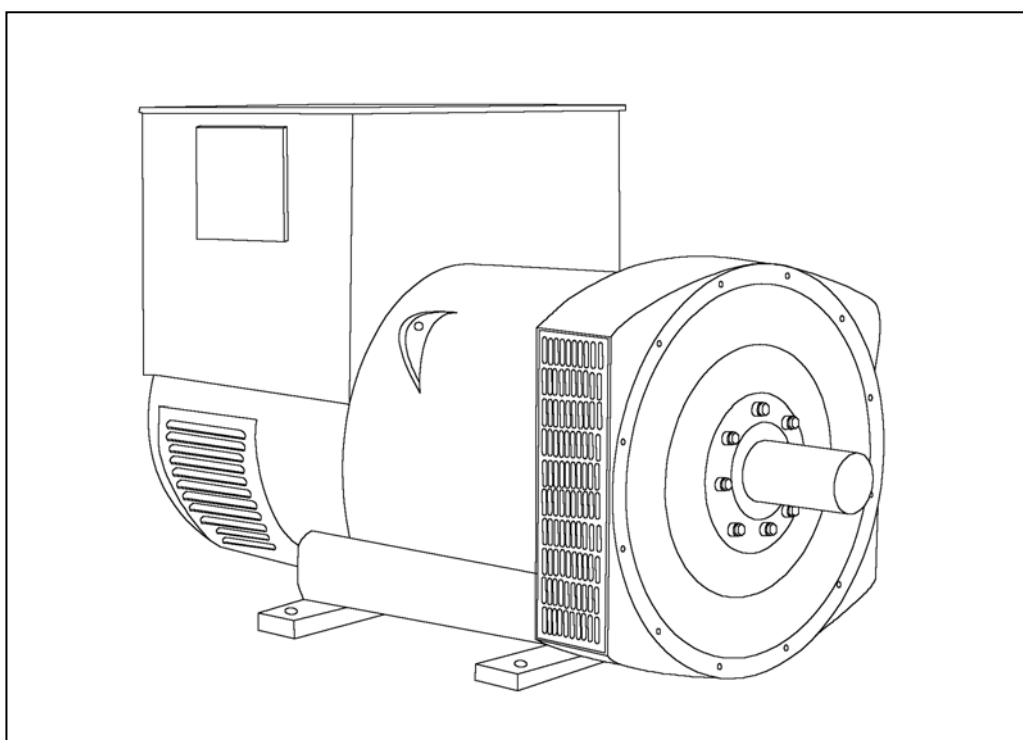

HCI434F/444F

SPECIFICATIONS & OPTIONS

STAMFORD

STANDARDS

Newage Stamford industrial generators meet the requirements of BS EN 60034 and the relevant section of other international standards such as BS5000, VDE 0530, NEMA MG1-32, IEC34, CSA C22.2-100, AS1359. Other standards and certifications can be considered on request.

VOLTAGE REGULATORS

AS440 AVR - STANDARD

With this self-excited system the main stator provides power via the Automatic Voltage Regulator (AVR) to the exciter stator. The high efficiency semi-conductors of the AVR ensure positive build-up from initial low levels of residual voltage.

The exciter rotor output is fed to the main rotor through a three-phase full-wave bridge rectifier. The rectifier is protected by a surge suppressor against surges caused, for example, by short circuit or out-of-phase paralleling.

The AS440 will support a range of electronic accessories, including a 'droop' Current Transformer (CT) to permit parallel operation with other ac generators.

MX341 AVR

This sophisticated AVR is incorporated into the Stamford Permanent Magnet Generator (PMG) control system.

The PMG provides power via the AVR to the main exciter, giving a source of constant excitation power independent of generator output. The main exciter output is then fed to the main rotor, through a full wave bridge, protected by a surge suppressor. The AVR has in-built protection against sustained over-excitation, caused by internal or external faults. This de-excites the machine after a minimum of 5 seconds.

An engine relief load acceptance feature can enable full load to be applied to the generator in a single step.

If three-phase sensing is required with the PMG system the MX321 AVR must be used.

We recommend three-phase sensing for applications with greatly unbalanced or highly non-linear loads.

MX321 AVR

The most sophisticated of all our AVRs combines all the features of the MX341 with, additionally, three-phase rms sensing, for improved regulation and performance.

Over voltage protection is built-in and short circuit current level adjustments is an optional facility.

WINDINGS & ELECTRICAL PERFORMANCE

All generator stators are wound to 2/3 pitch. This eliminates triplen (3rd, 9th, 15th ...) harmonics on the voltage waveform and is found to be the optimum design for trouble-free supply of non-linear loads. The 2/3 pitch design avoids excessive neutral currents sometimes seen with higher winding pitches, when in parallel with the mains. A fully connected damper winding reduces oscillations during paralleling. This winding, with the 2/3 pitch and carefully selected pole and tooth designs, ensures very low waveform distortion.

TERMINALS & TERMINAL BOX

Standard generators are 3-phase reconnectable with 12 ends brought out to the terminals, which are mounted on a cover at the non-drive end of the generator. A sheet steel terminal box contains the AVR and provides ample space for the customers' wiring and gland arrangements. It has removable panels for easy access.

SHAFT & KEYS

All generator rotors are dynamically balanced to better than BS6861:Part 1 Grade 2.5 for minimum vibration in operation. Two bearing generators are balanced with a half key.

INSULATION/IMPREGNATION

The insulation system is class 'H'.

All wound components are impregnated with materials and processes designed specifically to provide the high build required for static windings and the high mechanical strength required for rotating components.

QUALITY ASSURANCE

Generators are manufactured using production procedures having a quality assurance level to BS EN ISO 9001.

The stated voltage regulation may not be maintained in the presence of certain radio transmitted signals. Any change in performance will fall within the limits of Criteria 'B' of EN 61000-6-2:2001. At no time will the steady-state voltage regulation exceed 2%.

NB Continuous development of our products entitles us to change specification details without notice, therefore they must not be regarded as binding.

Front cover drawing typical of product range.

HCI434F/444F



WINDING 311

CONTROL SYSTEM	SEPARATELY EXCITED BY P.M.G.							
A.V.R.	MX321	MX341						
VOLTAGE REGULATION	± 0.5 %	± 1.0 %	With 4% ENGINE GOVERNING					
SUSTAINED SHORT CIRCUIT	REFER TO SHORT CIRCUIT DECREMENT CURVES (page 7)							
CONTROL SYSTEM	SELF EXCITED							
A.V.R.	AS440							
VOLTAGE REGULATION	± 1.0 %	With 4% ENGINE GOVERNING						
SUSTAINED SHORT CIRCUIT	WILL NOT SUSTAIN A SHORT CIRCUIT							
INSULATION SYSTEM	CLASS H							
PROTECTION	IP23							
RATED POWER FACTOR	0.8							
STATOR WINDING	DOUBLE LAYER LAP							
WINDING PITCH	TWO THIRDS							
WINDING LEADS	12							
STATOR WDG. RESISTANCE	0.0073 Ohms PER PHASE AT 22°C SERIES STAR CONNECTED							
ROTOR WDG. RESISTANCE	1.37 Ohms at 22°C							
EXCITER STATOR RESISTANCE	18 Ohms at 22°C							
EXCITER ROTOR RESISTANCE	0.068 Ohms PER PHASE AT 22°C							
R.F.I. SUPPRESSION	BS EN 61000-6-2 & BS EN 61000-6-4, VDE 0875G, VDE 0875N. refer to factory for others							
WAVEFORM DISTORTION	NO LOAD < 1.5% NON-DISTORTING BALANCED LINEAR LOAD < 5.0%							
MAXIMUM OVERSPEED	2250 Rev/Min							
BEARING DRIVE END	BALL. 6317 (ISO)							
BEARING NON-DRIVE END	BALL. 6314 (ISO)							
	1 BEARING				2 BEARING			
WEIGHT COMP. GENERATOR	1160 kg				1160 kg			
WEIGHT WOUND STATOR	535 kg				535 kg			
WEIGHT WOUND ROTOR	463 kg				440 kg			
WR ² INERTIA	5.4292 kgm ²				5.2304 kgm ²			
SHIPPING WEIGHTS in a crate	1230 kg				1230 kg			
PACKING CRATE SIZE	155 x 87 x 107(cm)				155 x 87 x 107(cm)			
	50 Hz				60 Hz			
TELEPHONE INTERFERENCE	THF<2%				TIF<50			
COOLING AIR	0.8 m ³ /sec 1700 cfm				0.99 m ³ /sec 2100 cfm			
VOLTAGE SERIES STAR	380/220	400/231	415/240	440/254	416/240	440/254	460/266	480/277
VOLTAGE PARALLEL STAR	190/110	200/115	208/120	220/127	208/120	220/127	230/133	240/138
VOLTAGE SERIES DELTA	220/110	230/115	240/120	254/127	240/120	254/127	266/133	277/138
KVA BASE RATING FOR REACTANCE VALUES	400	400	400	400	455	480	500	500
X _d DIR. AXIS SYNCHRONOUS	2.72	2.45	2.28	2.03	3.28	3.09	2.95	2.71
X' _d DIR. AXIS TRANSIENT	0.18	0.16	0.15	0.13	0.18	0.17	0.16	0.15
X'' _d DIR. AXIS SUBTRANSIENT	0.13	0.12	0.11	0.10	0.13	0.12	0.12	0.11
X _q QUAD. AXIS REACTANCE	2.35	2.12	1.97	1.75	2.90	2.73	2.61	2.39
X'' _q QUAD. AXIS SUBTRANSIENT	0.31	0.28	0.26	0.23	0.43	0.41	0.39	0.35
X _L LEAKAGE REACTANCE	0.06	0.05	0.05	0.04	0.07	0.07	0.06	0.06
X ₂ NEGATIVE SEQUENCE	0.23	0.20	0.19	0.17	0.29	0.27	0.26	0.24
X ₀ ZERO SEQUENCE	0.08	0.08	0.07	0.06	0.10	0.09	0.09	0.08
REACTANCES ARE SATURATED				VALUES ARE PER UNIT AT RATING AND VOLTAGE INDICATED				
T' _d TRANSIENT TIME CONST.	0.08s							
T'' _d SUB-TRANSTIME CONST.	0.019s							
T' _{do} O.C. FIELD TIME CONST.	1.7s							
T _a ARMATURE TIME CONST.	0.018s							
SHORT CIRCUIT RATIO	1/X _d							

50
Hz

HCI434F/444F
Winding 311

STAMFORD

THREE PHASE EFFICIENCY CURVES

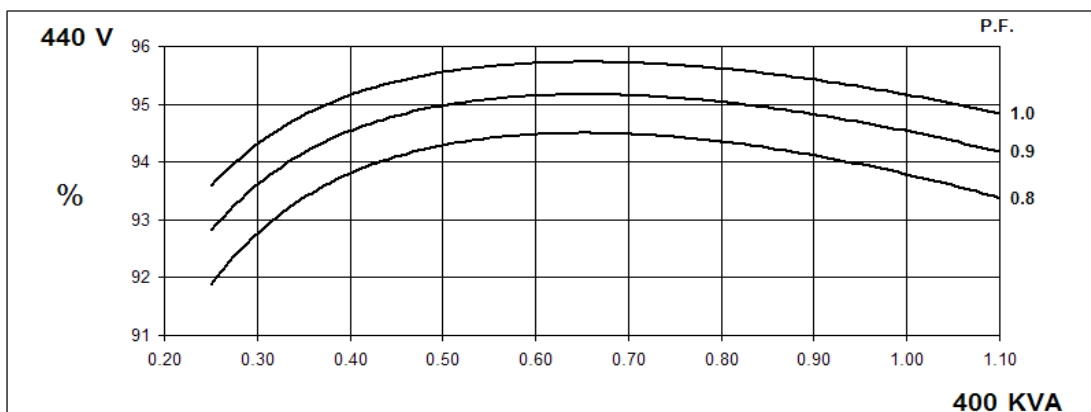
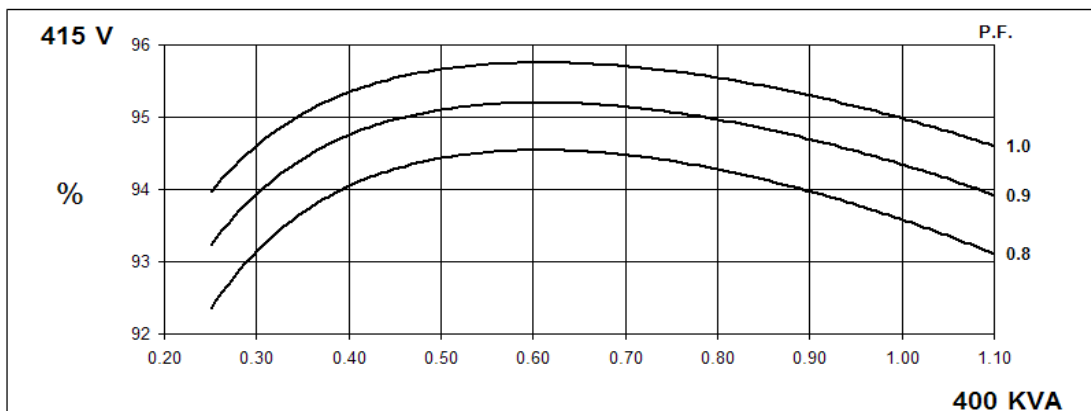
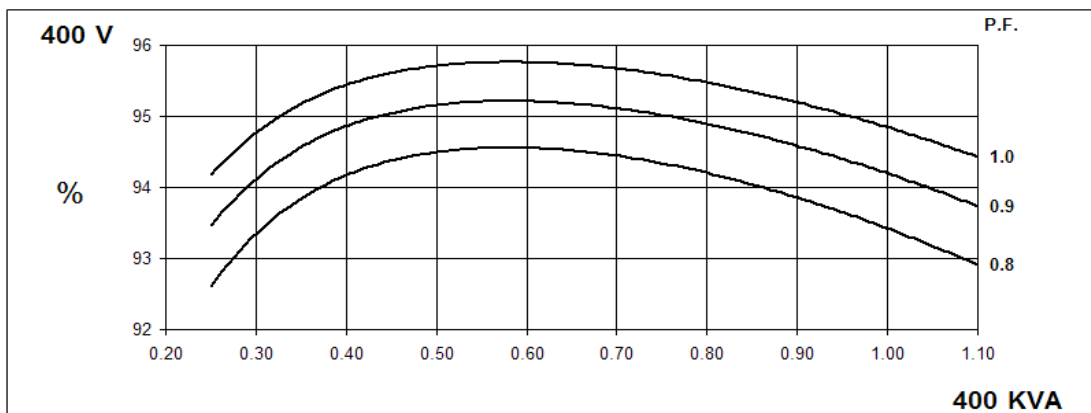
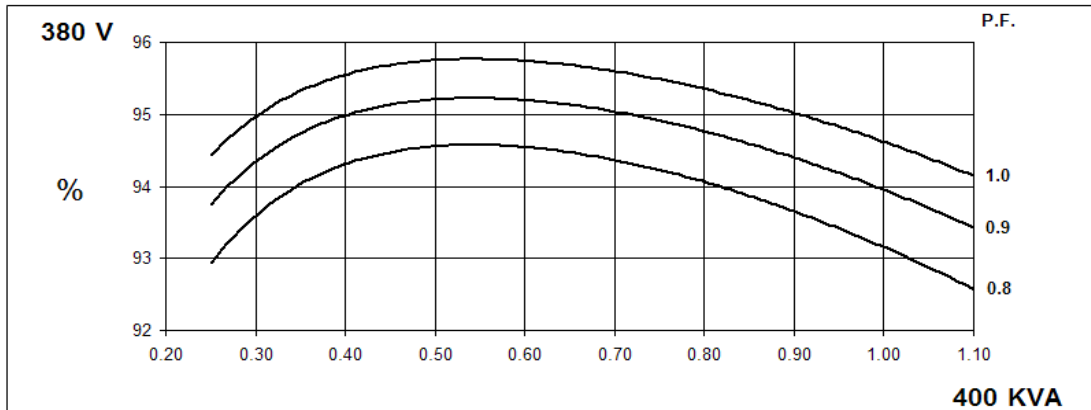

60
Hz

HCI434F/444F
Winding 311

STAMFORD

THREE PHASE EFFICIENCY CURVES

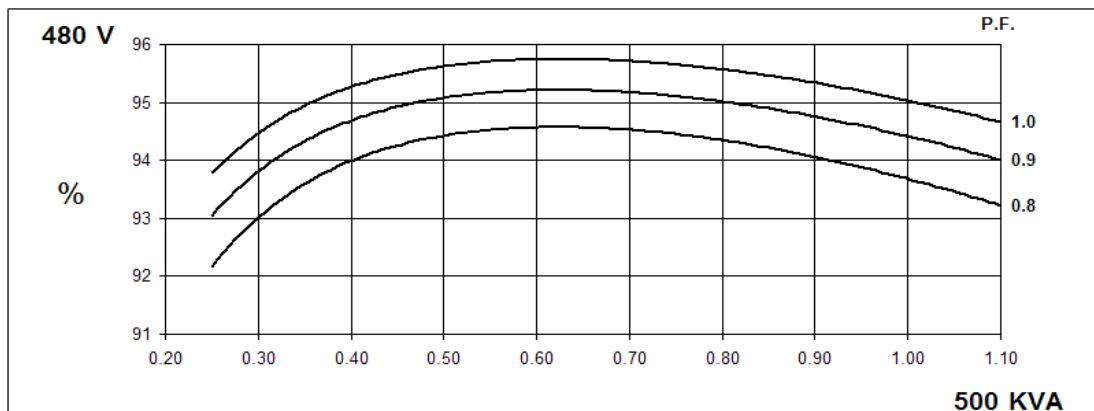
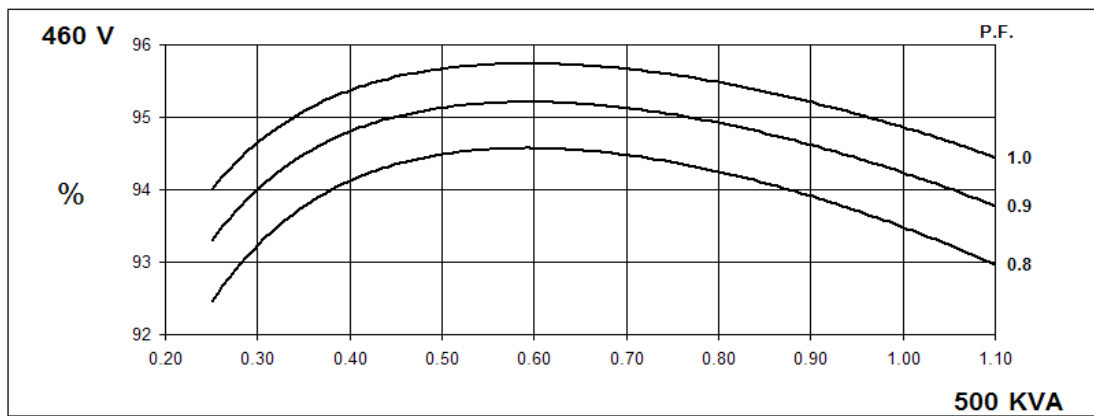
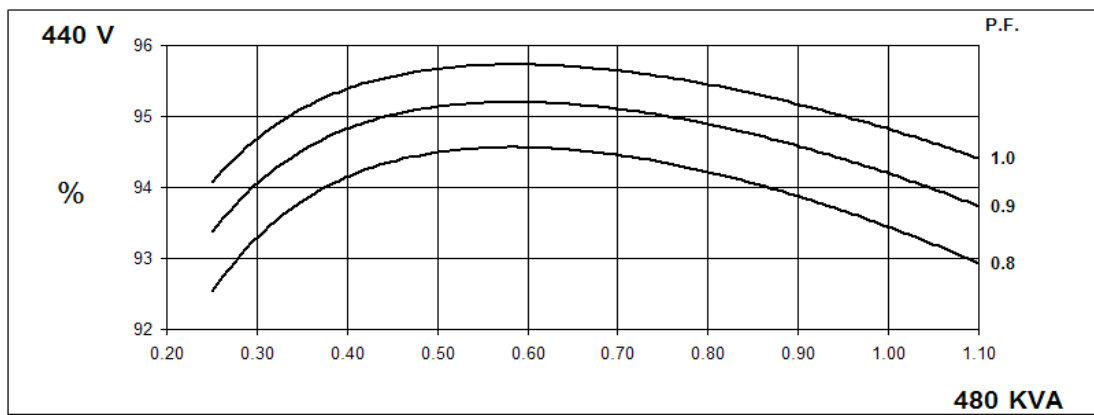
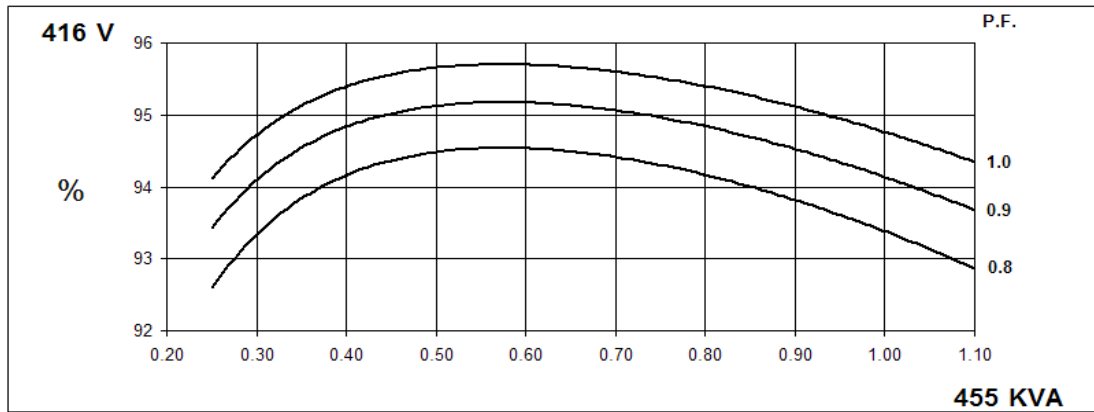

Locked Rotor Motor Starting Curve

50
Hz

MX

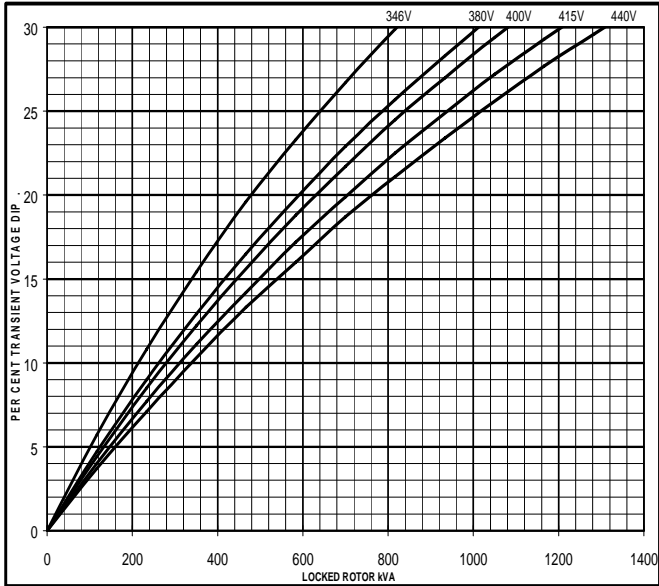

SX

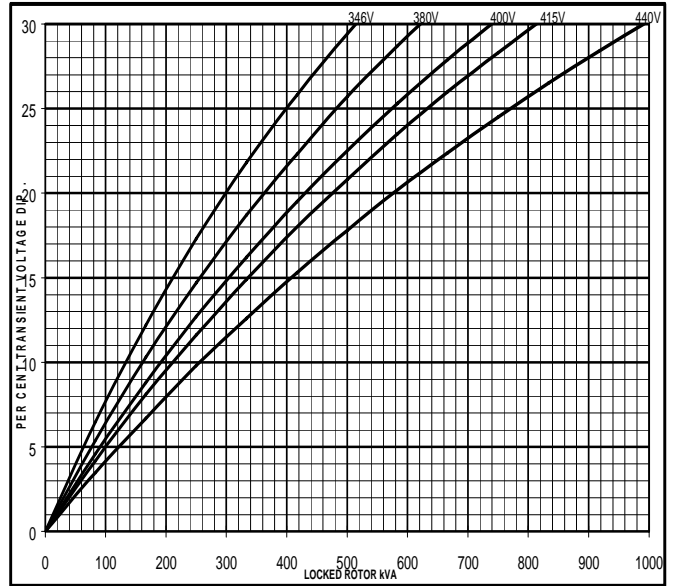

60
Hz

MX

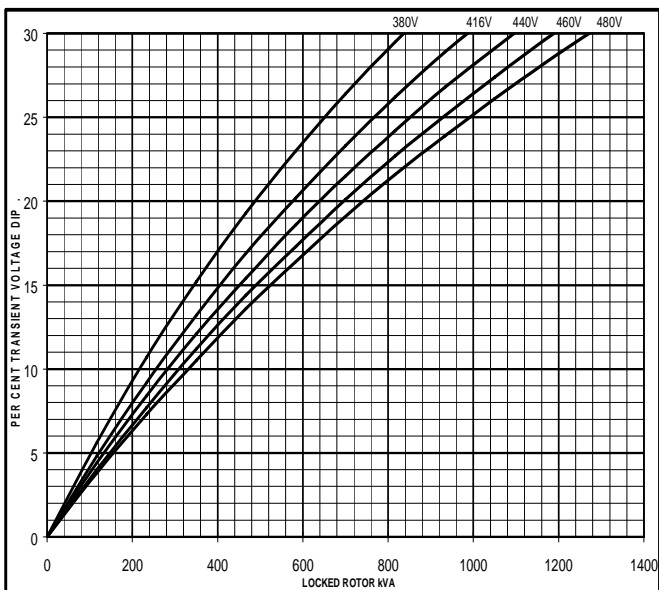

SX

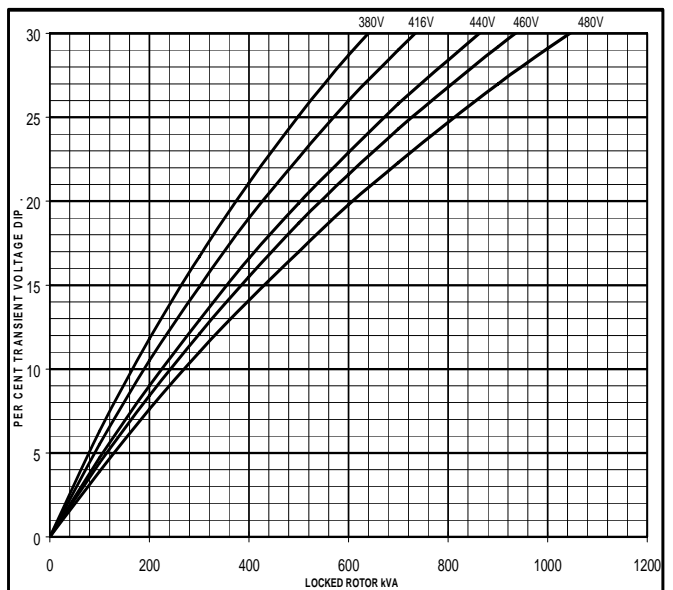

**Three-phase Short Circuit Decrement Curve. No-load Excitation at Rated Speed
Based on star (wye) connection.**

**50
Hz**

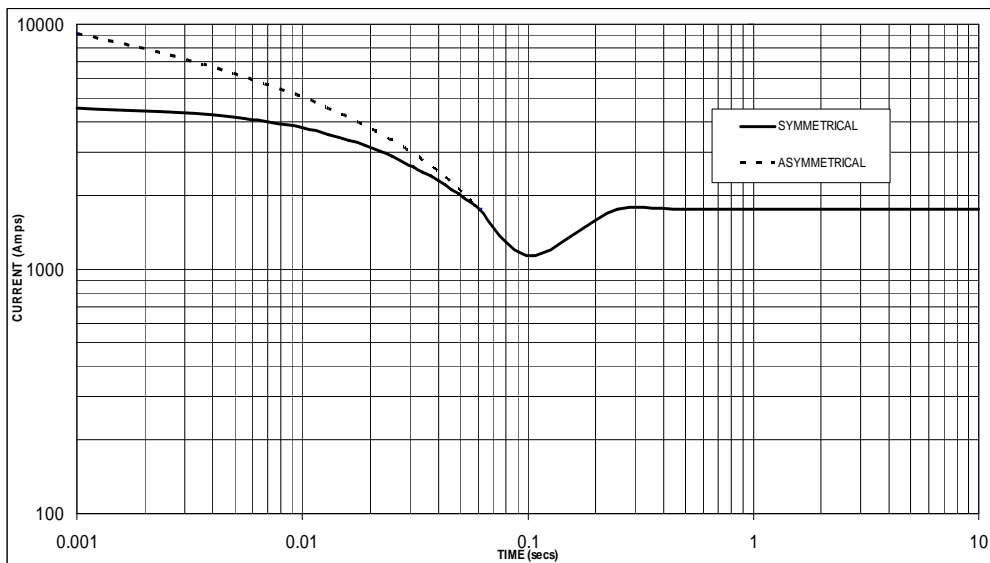

Sustained Short Circuit = 1,750 Amps

**60
Hz**

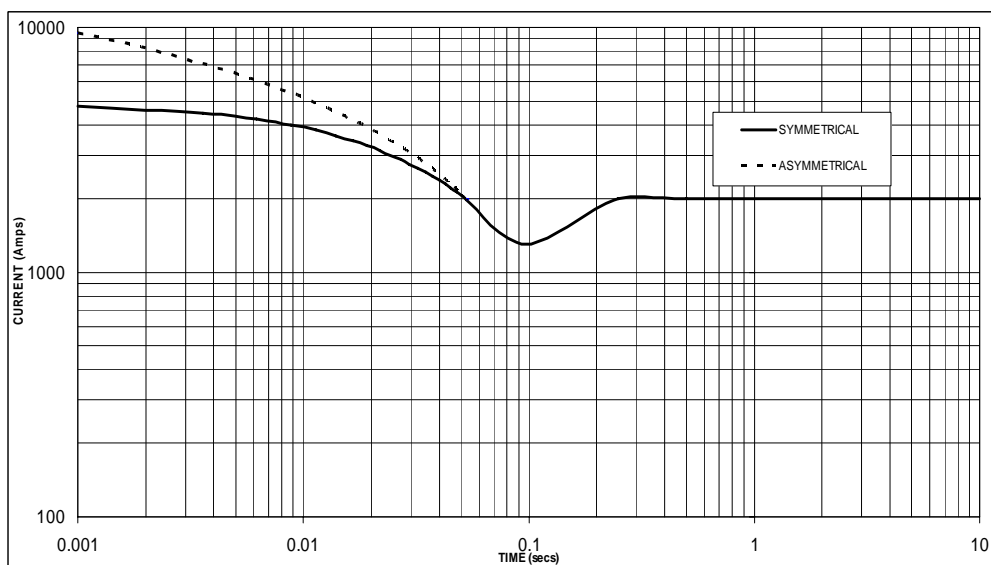

Sustained Short Circuit = 2,000 Amps

Note 1

The following multiplication factors should be used to adjust the values from curve between time 0.001 seconds and the minimum current point in respect of nominal operating voltage :

50Hz		60Hz	
Voltage	Factor	Voltage	Factor
380v	X 1.00	416v	X 1.00
400v	X 1.05	440v	X 1.06
415v	X 1.09	460v	X 1.10
440v	X 1.16	480v	X 1.15

The sustained current value is constant irrespective of voltage level

Note 2

The following multiplication factor should be used to convert the values calculated in accordance with NOTE 1 to those applicable to the various types of short circuit :

	3-phase	2-phase L-L	1-phase L-N
Instantaneous	x 1.00	x 0.87	x 1.30
Minimum	x 1.00	x 1.80	x 3.20
Sustained	x 1.00	x 1.50	x 2.50
Max. sustained duration	10 sec.	5 sec.	2 sec.

Note 3

All other times are unchanged

Curves are drawn for Star (Wye) connected machines. For other connection the following multipliers should be applied to current values as shown :

Parallel Star = Curve current value X 2

HCI434F/444F

Winding 311 / 0.8 Power Factor

STAMFORD

RATINGS

Class - Temp Rise	Cont. F - 105/40°C				Cont. H - 125/40°C				Standby - 150/40°C				Standby - 163/27°C				
50 Hz	Series Star (V)	380	400	415	440	380	400	415	440	380	400	415	440	380	400	415	440
	Parallel Star (V)	190	200	208	220	190	200	208	220	190	200	208	220	190	200	208	220
	Series Delta (V)	220	230	240	254	220	230	240	254	220	230	240	254	220	230	240	254
kVA	370	370	370	370	400	400	400	400	415	430	430	430	425	450	440	440	
kW	296	296	296	296	320	320	320	320	332	344	344	344	340	360	352	352	
Efficiency (%)	93.5	93.8	93.9	94.0	93.2	93.4	93.6	93.8	92.9	93.0	93.2	93.5	92.8	92.8	93.1	93.4	
kW Input	317	316	315	315	343	343	342	341	357	370	369	368	366	388	378	377	

60 Hz	Series Star (V)	416	440	460	480	416	440	460	480	416	440	460	480	416	440	460	480
	Parallel Star (V)	208	220	230	240	208	220	230	240	208	220	230	240	208	220	230	240
	Series Delta (V)	240	254	266	277	240	254	266	277	240	254	266	277	240	254	266	277
kVA	420	445	465	465	455	480	500	500	485	515	535	535	500	530	550	550	
kW	336	356	372	372	364	384	400	400	388	412	428	428	400	424	440	440	
Efficiency (%)	93.7	93.8	93.8	94.0	93.4	93.4	93.5	93.7	93.1	93.1	93.1	93.4	92.9	92.9	93.0	93.2	
kW Input	359	380	397	396	390	411	428	427	417	443	460	458	431	456	473	472	

DIMENSIONS

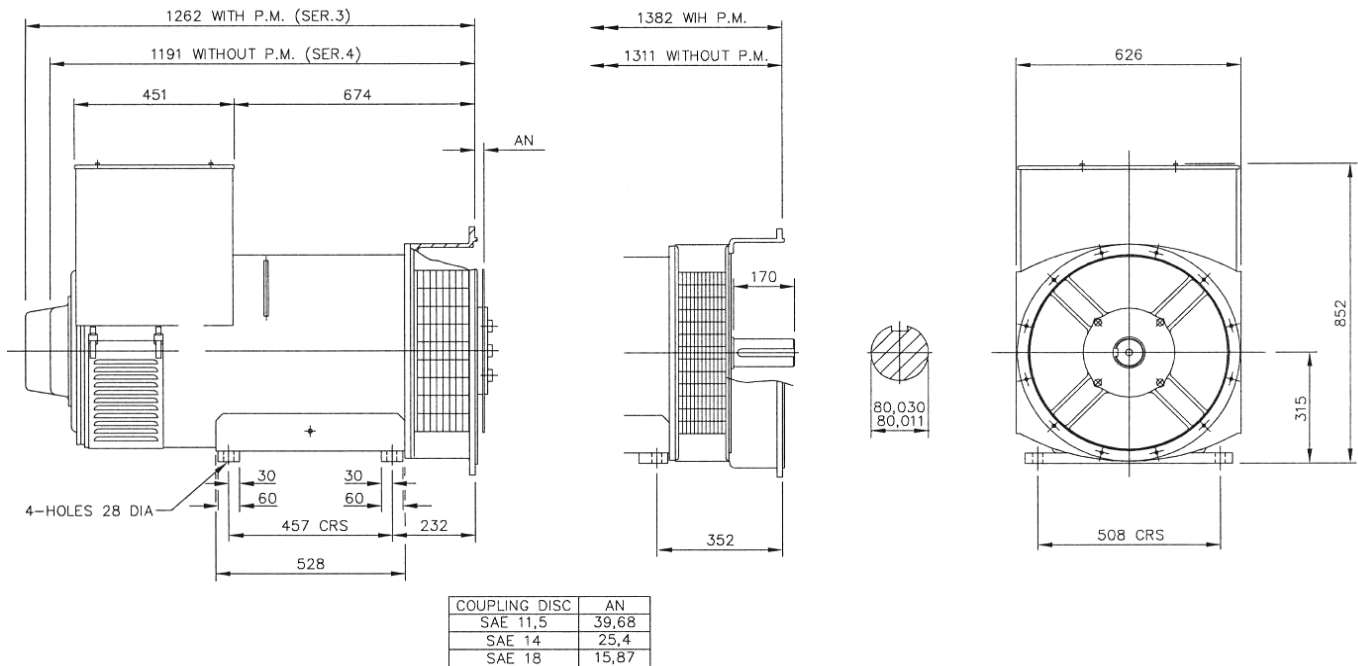

STAMFORD

Barnack Road • Stamford • Lincolnshire • PE9 2NB
Tel: 00 44 (0)1780 484000 • Fax: 00 44 (0)1780 484100

QST30-G4

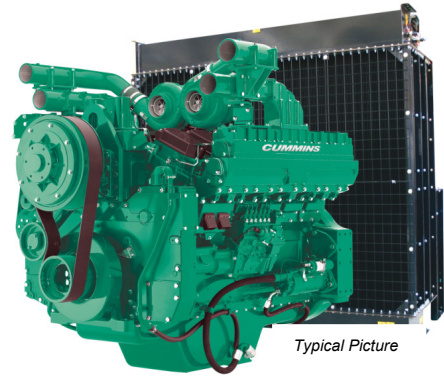

Typical Picture

> Specification sheet

Our energy working for you.™



Description

The QST30 Quantum series utilizes sophisticated electronics and premium engineering to provide outstanding performance levels from its compact 30 liter, V12 configuration.

In fact, the QST30-Series delivers more power and torque in a smaller package than any other diesel engine on the market.



This engine has been built to comply with CE certification.



This engine has been designed in facilities certified to ISO9001 and manufactured in facilities certified to ISO9001 or ISO9002.

Features

Quantum electronic fuel systems and controls provide superior performance, efficiency and diagnostics. The electronic fuel pumps deliver up to 1100 bar injection pressure and eliminate mechanical linkage adjustments. Electronic control module with PGI (Power Generation Interface) provides full authority electronic control over fuel management, G-drive features, protection and diagnostics.

CTT (Cummins Turbo Technologies) HX82 turbo charging utilises exhaust energy with greater efficiency for improved emissions and fuel consumption.

Cast Iron Pistons – High strength design delivers superior durability.

Coolpac Integrated Design - Products are supplied complete with cooling package and air cleaner kit for a complete power package. Each component has been specifically developed and rigorously tested for G-Drive products, ensuring high performance, durability and reliability.

Service and Support - G-Drive products are backed by an uncompromising level of technical support and after sales service, delivered through a world class service network.

1500 rpm (50 Hz Ratings)

Gross Engine Output			Net Engine Output			Typical Generator Set Output					
Standby	Prime	Base	Standby	Prime	Base	Standby (ESP)		Prime (PRP)		Base (COP)	
kWm/BHP			kWm/BHP			kWe	kVA	kWe	kVA	kWe	kVA
970/1300	880/1180	683/915	943/1264	853/1143	656/879	880	1100	800	1000	683	791

1800 rpm (60 Hz Ratings)

Gross Engine Output			Net Engine Output			Typical Generator Set Output					
Standby	Prime	Base	Standby	Prime	Base	Standby (ESP)		Prime (PRP)		Base (COP)	
kWm/BHP			kWm/BHP			kWe	kVA	kWe	kVA	kWe	kVA
1112/1490	1007/1350	832/1115	1070/1434	965/1294	790/1059	1012	1265	920	1150	752	940



General Engine Data

Type	4 cycle, in line, Turbocharged ,Air Cooled		
Bore mm	140.0		
Stroke mm	165.1		
Displacement Litre	30.5		
Cylinder Block	Cast iron, 50°V 12 cylinder		
Battery Charging Alternator	35A		
Starting Voltage	24V		
Fuel System	Direct injection		
Fuel Filter	Spin on fuel filters with water separator		
Lube Oil Filter Type(s)	Spin on full flow filter		
Lube Oil Capacity (l)	154		
Flywheel Dimensions	SAE 0		

CoolPac Performance Data

Cooling System Design	Air to Air Charge Cooled		
Coolant Ratio	50% ethylene glycol; 50% water		
Total Coolant Capacity (l)	192		
Limiting Ambient Temp. (°C)**	52 (50Hz)	52.3 (60Hz)	
Fan Power (kWm)	27 (50Hz)	42 (60Hz)	
Cooling System Air Flow (m ³ /s)**	12.6 (50Hz)	17.07 (60Hz)	
Air Cleaner Type	"Normal Duty" dry replaceable element with restriction indicator		

** @ 13 mm H₂O

CoolPac Weight & Dimensions

Length mm	Width mm	Height mm	Weight (dry) kg
3008	1429	2275	3662

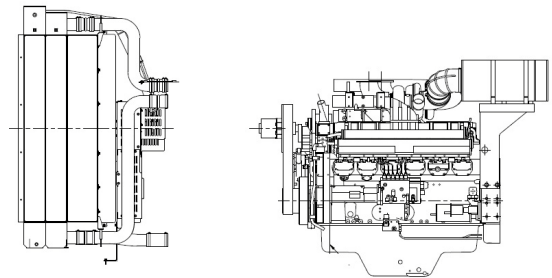

Fuel Consumption 1500 rpm (50 Hz)

%	kWm	BHP	L/ph	US gal/ph
Standby Power				
100	970	1300	224	59.1
Prime Power				
100	880	1180	202	53.2
75	660	885	151	39.8
50	440	590	102	26.9
25	220	295	54	14.2
Continuous Power				
100	683	915	156	41.1

Fuel Consumption 1800 rpm (60 Hz)

%	kWm	BHP	L/ph	US gal/ph
Standby Power				
100	1112	1490	267	70.5
Prime Power				
100	1007	1350	240	63.3
75	756	1013	177	46.7
50	504	675	119	31.5
25	252	338	66	17.4
Continuous Power				
100	832	1115	194	51.4

Cummins G-Drive Engines

Asia Pacific

10 Toh Guan Road
#07-01
TT International Tradepark
Singapore 608838
Phone 65 6417 2388
Fax 65 6417 2399

Europe, CIS, Middle East and Africa

Manston Park Columbus Ave
Manston Ramsgate
Kent CT12 5BF, UK
Phone 44 1843 255000
Fax 44 1843 255902

Latin America

Rua Jati, 310, Cumbica
Guarulhos, SP 07180-900
Brazil
Phone 55 11 2186 4552
Fax 55 11 2186 4729

Mexico

Cummins S. de R.L. de C.V.
Eje 122 No. 200 Zona Industrial
San Luis Potosí, S.L.P. 78090
Mexico
Phone 52 444 870 6700
Fax 52 444 870 6811

North America

1400 73rd Avenue N.E.
Minneapolis, MN 55432
USA
Phone 1 763 574 5000
USA Toll-free 1 877 769 7669
Fax 1 763 574 5298



HCI634J - Technical Data Sheet

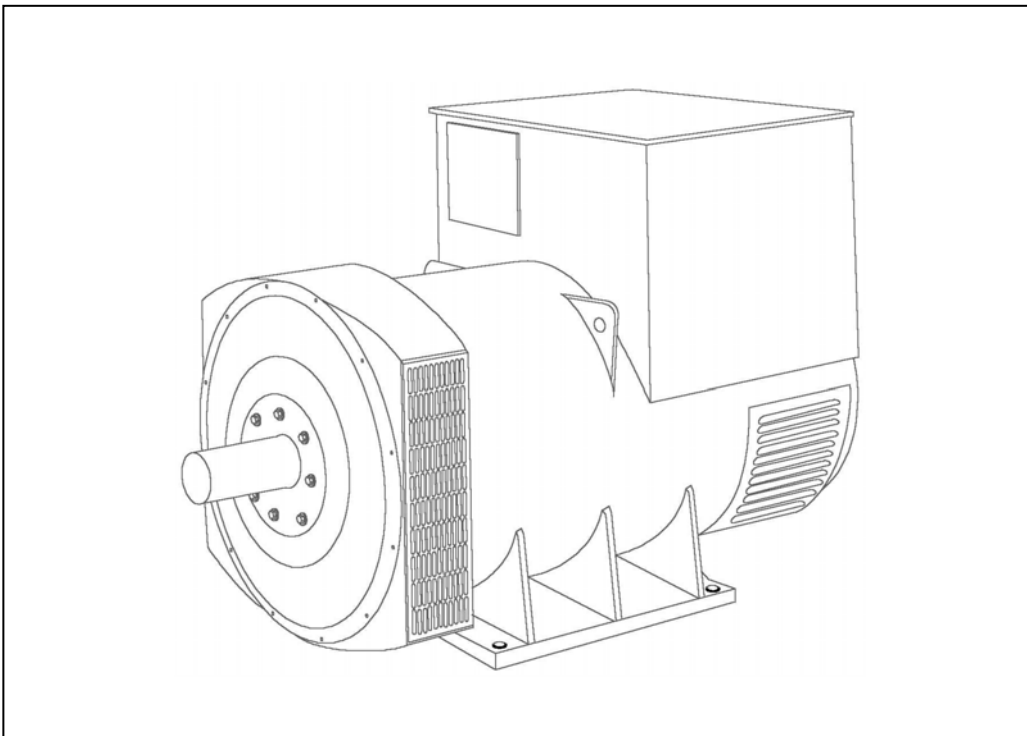

HCI634J

SPECIFICATIONS & OPTIONS



STANDARDS

Newage Stamford industrial generators meet the requirements of BS EN 60034 and the relevant section of other international standards such as BS5000, VDE 0530, NEMA MG1-32, IEC34, CSA C22.2-100, AS1359. Other standards and certifications can be considered on request.

VOLTAGE REGULATORS

MX321 AVR - STANDARD

This sophisticated Automatic Voltage Regulator (AVR) is incorporated into the Stamford Permanent Magnet Generator (PMG) system and is fitted as standard to generators of this type.

The PMG provides power via the AVR to the main exciter, giving a source of constant excitation power independent of generator output. The main exciter output is then fed to the main rotor, through a full wave bridge, protected by a surge suppressor. The AVR has in-built protection against sustained over-excitation, caused by internal or external faults. This de-excites the machine after a minimum of 5 seconds.

Over voltage protection is built-in and short circuit current level adjustments is an optional facility.

WINDINGS & ELECTRICAL PERFORMANCE

All generator stators are wound to 2/3 pitch. This eliminates triplen (3rd, 9th, 15th ...) harmonics on the voltage waveform and is found to be the optimum design for trouble-free supply of non-linear loads. The 2/3 pitch design avoids excessive neutral currents sometimes seen with higher winding pitches, when in parallel with the mains. A fully connected damper winding reduces oscillations during paralleling. This winding, with the 2/3 pitch and carefully selected pole and tooth designs, ensures very low waveform distortion.

TERMINALS & TERMINAL BOX

Standard generators feature a main stator with 6 ends brought out to the terminals, which are mounted on the frame at the non-drive end of the generator. A sheet steel terminal box contains the AVR and provides ample space for the customers' wiring and gland arrangements. It has removable panels for easy access.

SHAFT & KEYS

All generator rotors are dynamically balanced to better than BS6861:Part 1 Grade 2.5 for minimum vibration in operation. Two bearing generators are balanced with a half key.

INSULATION/IMPREGNATION

The insulation system is class 'H'.

All wound components are impregnated with materials and processes designed specifically to provide the high build required for static windings and the high mechanical strength required for rotating components.

QUALITY ASSURANCE

Generators are manufactured using production procedures having a quality assurance level to BS EN ISO 9001.

The stated voltage regulation may not be maintained in the presence of certain radio transmitted signals. Any change in performance will fall within the limits of Criteria 'B' of EN 61000-6-2:2001. At no time will the steady-state voltage regulation exceed 2%.

NB Continuous development of our products entitles us to change specification details without notice, therefore they must not be regarded as binding.

Front cover drawing typical of product range.

HCI634J
WINDING 312

CONTROL SYSTEM	SEPARATELY EXCITED BY P.M.G.	
A.V.R.	MX321	
VOLTAGE REGULATION	± 0.5 %	With 4% ENGINE GOVERNING
SUSTAINED SHORT CIRCUIT	REFER TO SHORT CIRCUIT DECREMENT CURVES (page 7)	

INSULATION SYSTEM	CLASS H							
PROTECTION	IP23							
RATED POWER FACTOR	0.8							
STATOR WINDING	DOUBLE LAYER LAP							
WINDING PITCH	TWO THIRDS							
WINDING LEADS	6							
STATOR WDG. RESISTANCE	0.002 Ohms PER PHASE AT 22°C STAR CONNECTED							
ROTOR WDG. RESISTANCE	2.09 Ohms at 22°C							
R.F.I. SUPPRESSION	BS EN 61000-6-2 & BS EN 61000-6-4, VDE 0875G, VDE 0875N. refer to factory for others							
WAVEFORM DISTORTION	NO LOAD < 1.5% NON-DISTORTING BALANCED LINEAR LOAD < 5.0%							
MAXIMUM OVERSPEED	2250 Rev/Min							
BEARING DRIVE END	BALL. 6224 (ISO)							
BEARING NON-DRIVE END	BALL. 6317 (ISO)							
	1 BEARING				2 BEARING			
WEIGHT COMP. GENERATOR	2279 kg				2300 kg			
WEIGHT WOUND STATOR	1120 kg				1120 kg			
WEIGHT WOUND ROTOR	962 kg				916 kg			
WR ² INERTIA	22.9287 kgm ²				22.3814 kgm ²			
SHIPPING WEIGHTS in a crate	2328kg				2329kg			
PACKING CRATE SIZE	183 x 92 x 140(cm)				183 x 92 x 140(cm)			
	50 Hz				60 Hz			
TELEPHONE INTERFERENCE	THF<2%				TIF<50			
COOLING AIR	1.614 m ³ /sec 3420 cfm				1.961 m ³ /sec 4156 cfm			
VOLTAGE STAR	380/220	400/231	415/240	440/254	416/240	440/254	460/266	480/277
VOLTAGE DELTA	220	230	240	254	240	254	266	277
kVA BASE RATING FOR REACTANCE VALUES	1000	1000	1000	1000	1150	1200	1250	1300
X _d DIR. AXIS SYNCHRONOUS	3.02	2.73	2.54	2.26	3.49	3.25	3.10	2.96
X' _d DIR. AXIS TRANSIENT	0.24	0.22	0.20	0.18	0.28	0.26	0.25	0.24
X'' _d DIR. AXIS SUBTRANSIENT	0.17	0.15	0.14	0.12	0.19	0.18	0.17	0.16
X _q QUAD. AXIS REACTANCE	1.78	1.61	1.50	1.33	2.05	1.91	1.82	1.74
X'' _q QUAD. AXIS SUBTRANSIENT	0.21	0.19	0.18	0.16	0.25	0.23	0.22	0.21
X _L LEAKAGE REACTANCE	0.09	0.08	0.08	0.07	0.10	0.10	0.09	0.09
X ₂ NEGATIVE SEQUENCE	0.21	0.19	0.18	0.16	0.25	0.23	0.22	0.21
X ₀ ZERO SEQUENCE	0.03	0.02	0.02	0.02	0.03	0.03	0.03	0.03
REACTANCES ARE SATURATED VALUES ARE PER UNIT AT RATING AND VOLTAGE INDICATED								
T' _d TRANSIENT TIME CONST.	0.185							
T'' _d SUB-TRANSTIME CONST.	0.025							
T' _{do} O.C. FIELD TIME CONST.	3.03							
T _a ARMATURE TIME CONST.	0.046							
SHORT CIRCUIT RATIO	1/X _d							

**50
Hz**

HCI634J
Winding 312



THREE PHASE EFFICIENCY CURVES

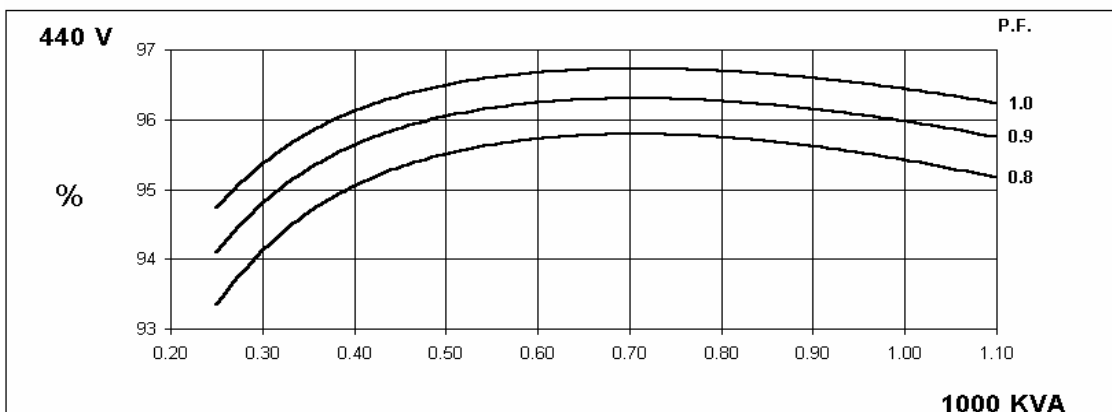
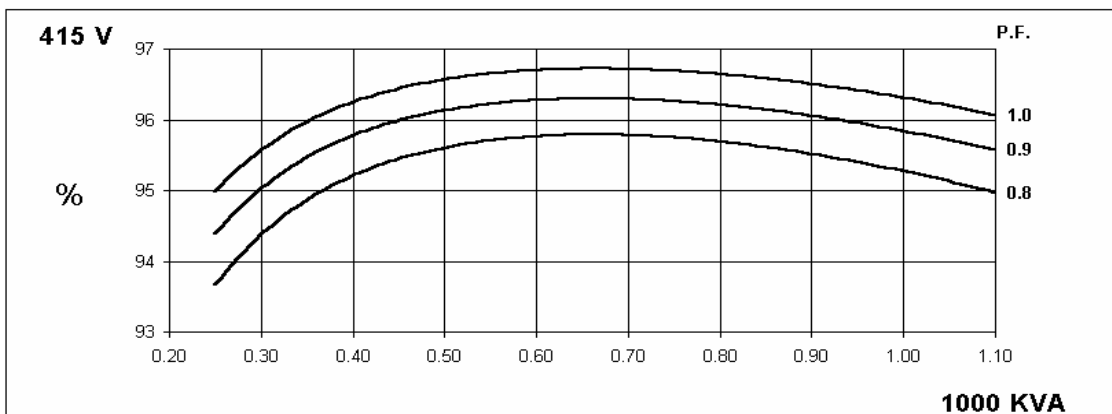
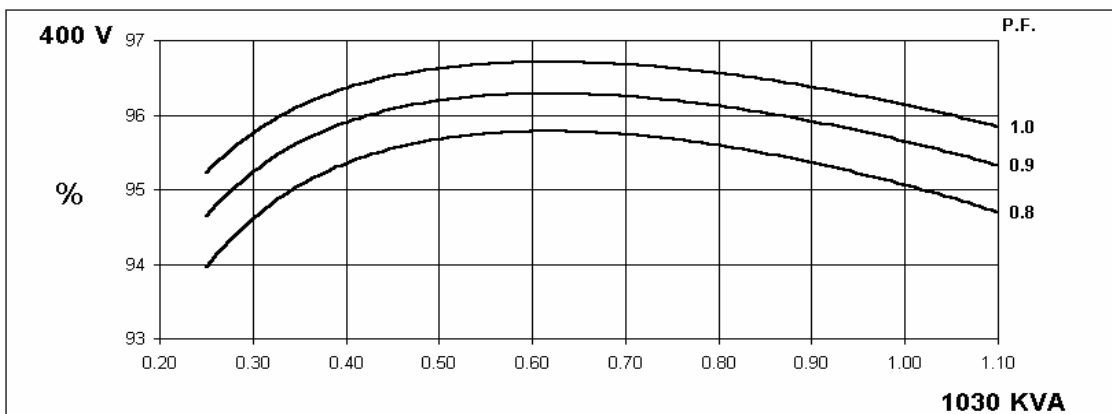
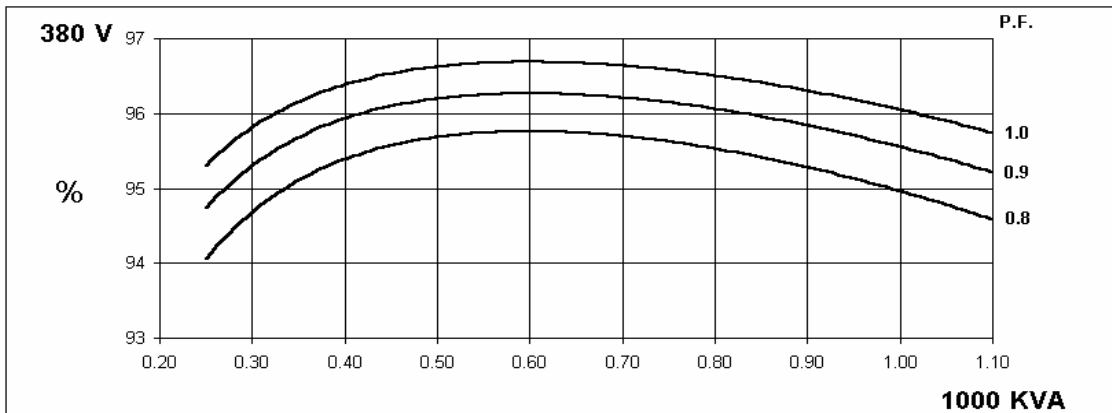

THREE PHASE EFFICIENCY CURVES

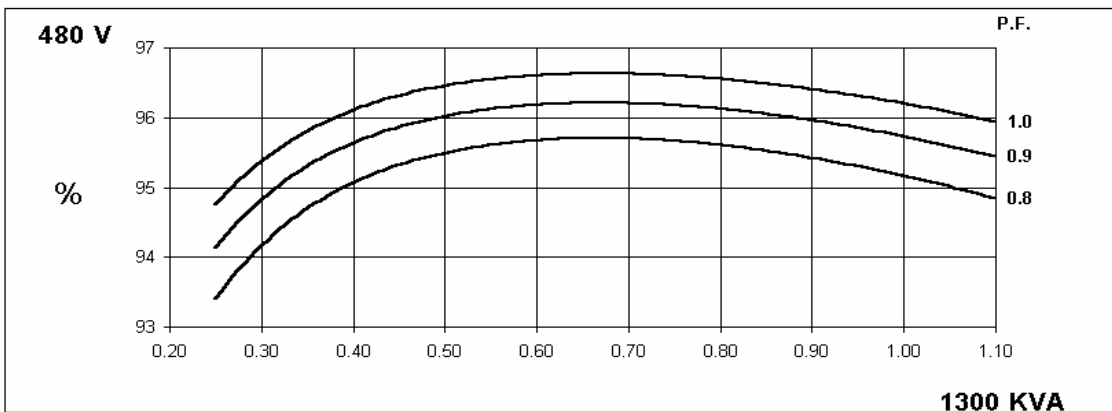
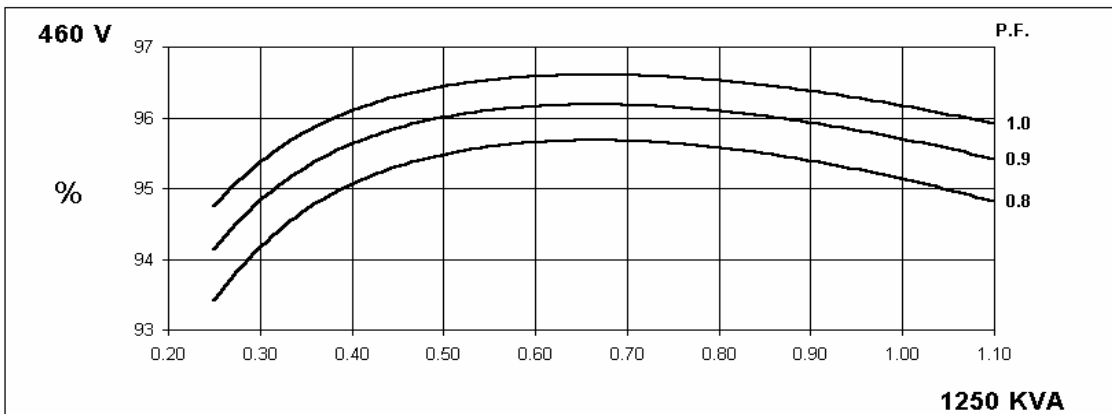
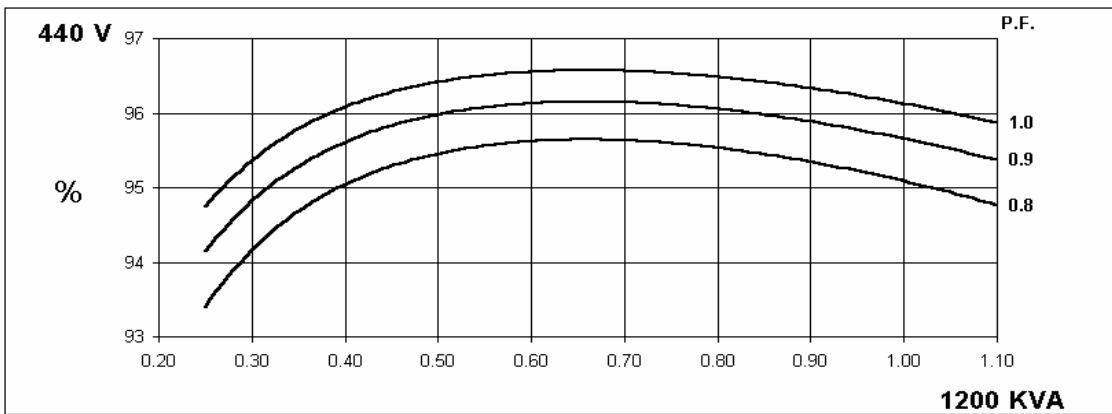
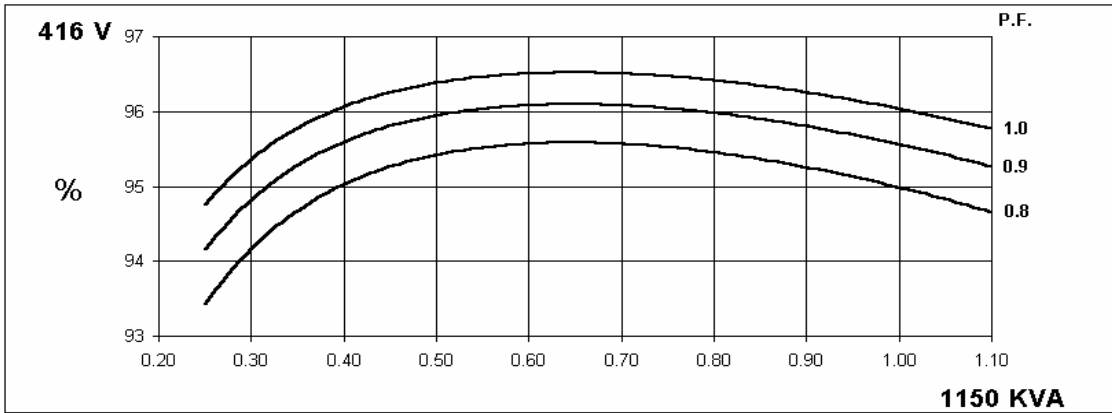

HCI634J

Winding 312



Locked Rotor Motor Starting Curve

**50
Hz**

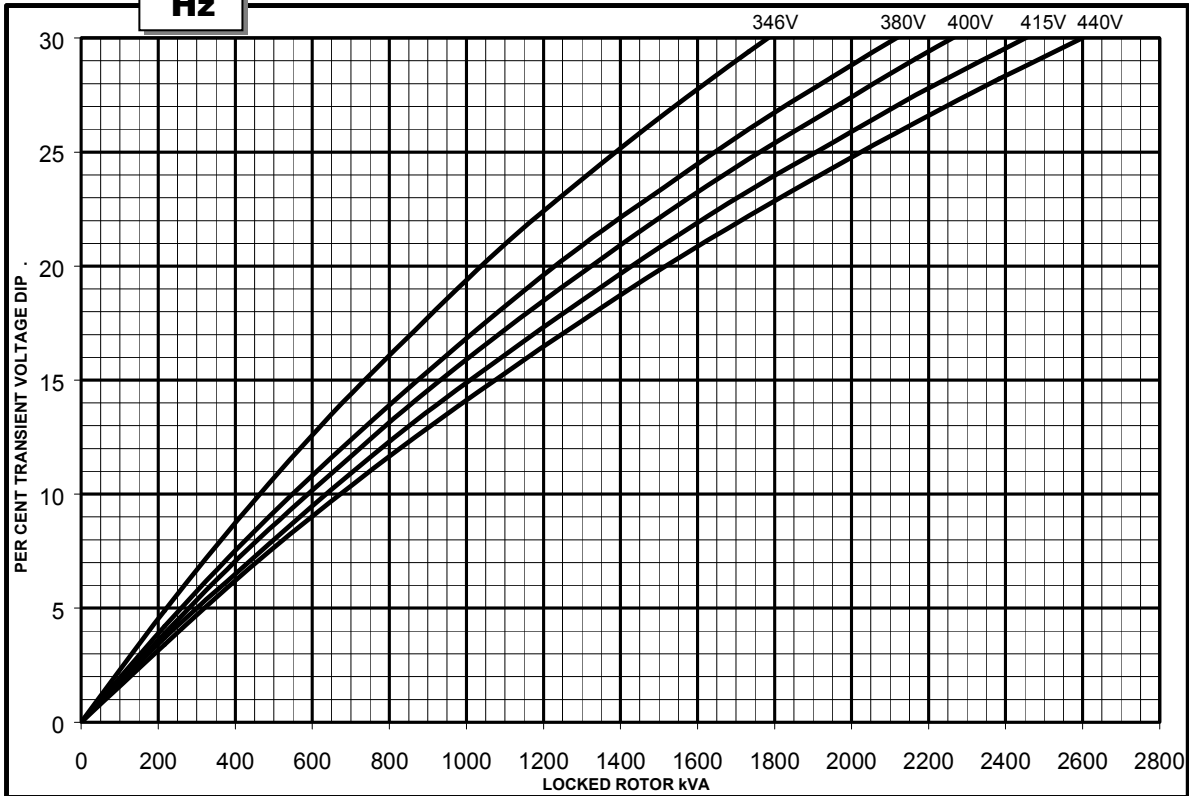

**60
Hz**

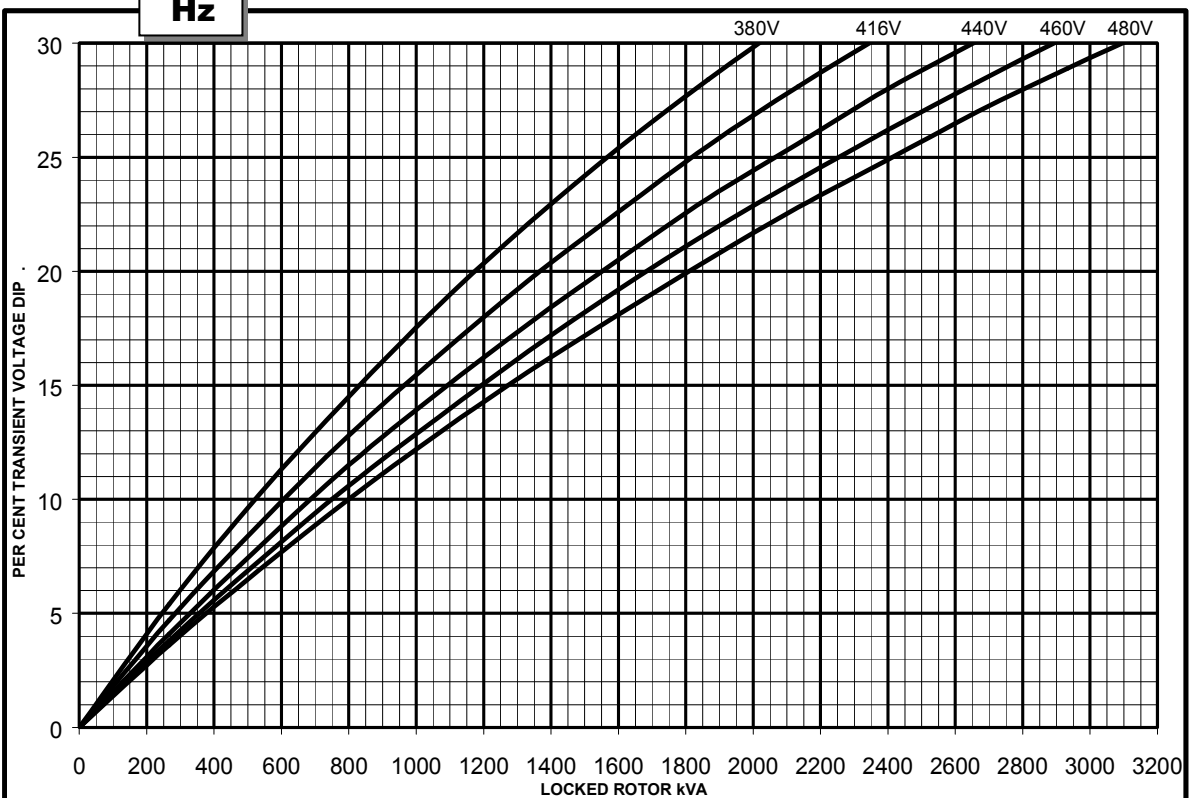

**Three-phase Short Circuit Decrement Curve. No-load Excitation at Rated Speed
Based on star (wye) connection.**

**50
Hz**

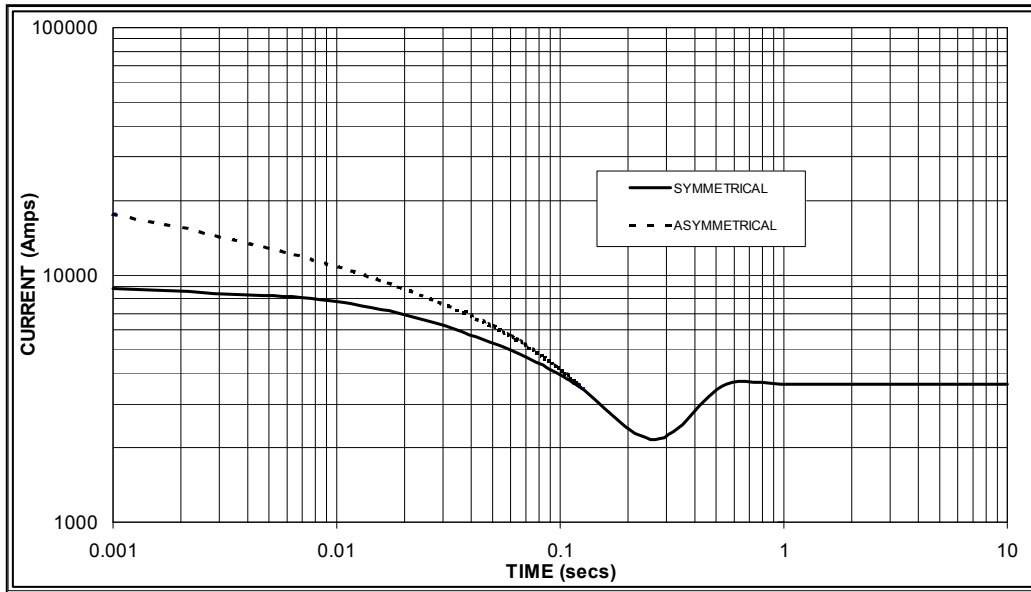

Sustained Short Circuit = 3,600 Amps

**60
Hz**

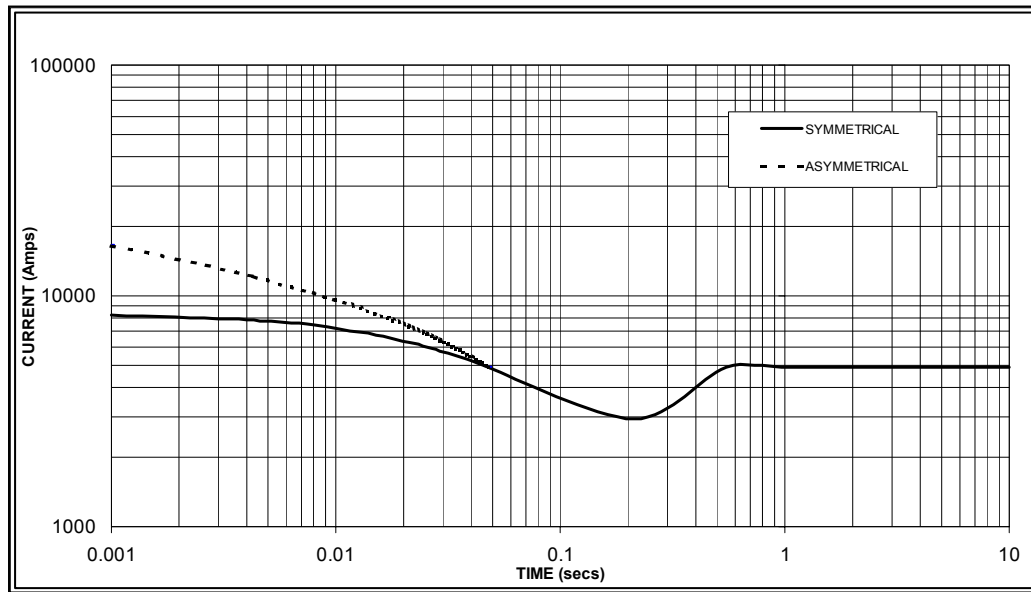

Sustained Short Circuit = 4,900 Amps

Note 1

The following multiplication factors should be used to adjust the values from curve between time 0.001 seconds and the minimum current point in respect of nominal operating voltage :

50Hz		60Hz	
Voltage	Factor	Voltage	Factor
380v	X 1.00	416v	x 1.00
400v	X 1.07	440v	x 1.06
415v	X 1.12	460v	x 1.12
440v	X 1.18	480v	x 1.17

The sustained current value is constant irrespective of voltage level

Note 2

The following multiplication factor should be used to convert the values calculated in accordance with NOTE 1 to those applicable to the various types of short circuit :

	3-phase	2-phase L-L	1-phase L-N
Instantaneous	x 1.00	x 0.87	x 1.30
Minimum	x 1.00	x 1.80	x 3.20
Sustained	x 1.00	x 1.50	x 2.50
Max. sustained duration	10 sec.	5 sec.	2 sec.

All other times are unchanged

Note 3

Curves are drawn for Star (Wye) connected machines.
For Delta connection multiply the Curve current value by 1.732

HCI634J

Winding 312 0.8 Power Factor



RATINGS

Class - Temp Rise		Cont. F - 105/40°C				Cont. H - 125/40°C				Standby - 150/40°C				Standby - 163/27°C			
50Hz	Star (V)	380	400	415	440	380	400	415	440	380	400	415	440	380	400	415	440
	Delta (V)	220	230	240	254	220	230	240	254	220	230	240	254	220	230	240	254
	kVA	900	927	900	900	1000	1030	1000	1000	1060	1070	1060	1060	1100	1110	1100	1100
	kW	720	742	720	720	800	824	800	800	848	856	848	848	880	888	880	880
	Efficiency (%)	95.3	95.4	95.5	95.6	95.0	95.1	95.3	95.4	94.7	94.9	95.1	95.3	94.6	94.8	95.0	95.2
	kW Input	756	777	754	753	842	866	839	839	895	902	892	890	930	937	926	924
60Hz	Star (V)	416	440	460	480	416	440	460	480	416	440	460	480	416	440	460	480
	Delta (V)	240	254	266	277	240	254	266	277	240	254	266	277	240	254	266	277
	kVA	1063	1100	1150	1188	1150	1200	1250	1300	1206	1250	1300	1350	1250	1300	1350	1400
	kW	850	880	920	950	920	960	1000	1040	965	1000	1040	1080	1000	1040	1080	1120
	Efficiency (%)	95.2	95.3	95.3	95.4	95.0	95.1	95.1	95.2	94.8	95.0	95.0	95.1	94.7	94.8	94.9	94.9
	kW Input	893	923	965	996	968	1009	1052	1092	1018	1053	1095	1136	1056	1097	1138	1180

DIMENSIONS

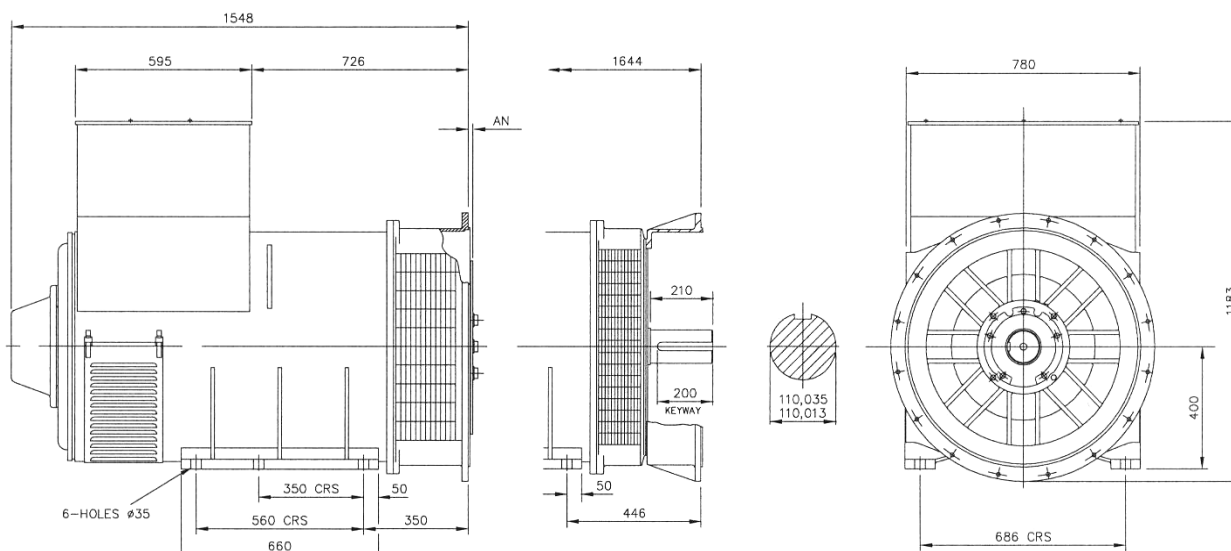

SAE	14	18	21	24
AN	25.4	15.87	0	0



PO Box 17 • Barnack Road • Stamford • Lincolnshire • PE9 2NB

Tel: 00 44 (0)1780 484000 • Fax: 00 44 (0)1780 484100

QSL9-G5

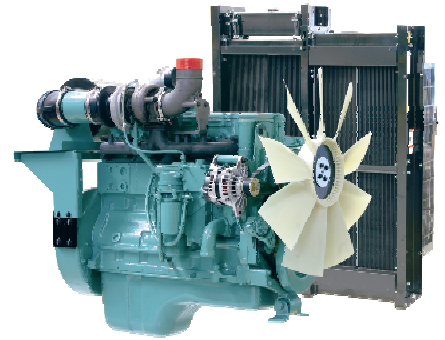

> Specification sheet



Our energy working for you.™

Description

Cummins QSL engines are built to deliver heavy-duty performance. Full-authority electronic engine controls combine with the high-pressure fuel system, 24-valve design and centred injectors for one of the highest power-to-weight ratios in its class. At the same time, the QSL delivers better fuel economy, has better cold starting capability and is up to 50% quieter in operation than its predecessors.



This engine has been built to comply with CE certification.



This engine has been designed in facilities certified to ISO9001 and manufactured in facilities certified to ISO9001 or ISO9002.

Features

Common Rail Fuel System and Controls - Bosch high pressure common rail (HPCR) - Optimize engine performance to provide seamless integration and advanced diagnostics and programming options.

Holset HX40 Turbo charging - Optimizes transient response.

Integrated Block Design - Integrated fluid circuits replace hoses and eliminate potential leaks.

24-Valve Cylinder Head – Four valves per cylinder for increased power with faster response and fuel economy.

Coolpac Integrated Design - Products are supplied complete with cooling package and air cleaner kit for a complete power package. Each component has been specifically developed and rigorously tested for G-Drive products, ensuring high performance, durability and reliability.

Service and Support - G-Drive products are backed by an uncompromising level of technical support and after sales service, delivered through a world class service network.

1500 rpm (50 Hz Ratings)

Gross Engine Output			Net Engine Output			Typical Generator Set Output					
Standby	Prime	Base	Standby	Prime	Base	Standby (ESP)		Prime (PRP)		Base (COP)	
kWm/BHP			kWm/BHP			kWe	kVA	kWe	kVA	kWe	kVA
310/415	268/359	228/305	297/398	258/345	218/292	264	330	240	300	203	254

1800 rpm (60 Hz Ratings)

Gross Engine Output			Net Engine Output			Typical Generator Set Output					
Standby	Prime	Base	Standby	Prime	Base	Standby (ESP)		Prime (PRP)		Base (COP)	
kWm/BHP			kWm/BHP			kWe	kVA	kWe	kVA	kWe	kVA
355/476	307/412	261/350	337/451	293/392	247/331	300	375	275	344	230	288



General Engine Data

Type	4 cycle, in-line, Turbo Charged, Air-cooled
Bore mm	114 mm (4.5in.)
Stroke mm	145 mm (5.7in.)
Displacement Litre	8.9 litre (543 in. ³)
Cylinder Block	Cast iron, 6 cylinder
Battery Charging Alternator	70 amps
Starting Voltage	24 volt, negative ground
Fuel System	Direct injection
Fuel Filter	Spin-on fuel filters with water separator
Lube Oil Filter Type(s)	Spin-on full flow filter
Lube Oil Capacity (l)	26.5
Flywheel Dimensions	SAE1

Coolpac Performance Data

Cooling System Design	Air-Air Charge Cooled
Coolant Ratio	50% ethylene glycol; 50% water
Coolant Capacity (l)	15.0
Limiting Ambient Temp.** (°C)	50 (50Hz); 55 (60Hz)
Fan Power (kWm)	10 (50Hz); 11 (60Hz)
Cooling System Air Flow (m ³ /s)**	7.9 (50Hz); 8 (60Hz)
Air Cleaner Type	Light duty dry replaceable element with restriction indicator

** @ 13 mm H₂O

Weight & Dimensions

Length	Width	Height	Weight (dry)
mm	mm	mm	kg
1624	1064	1463	861

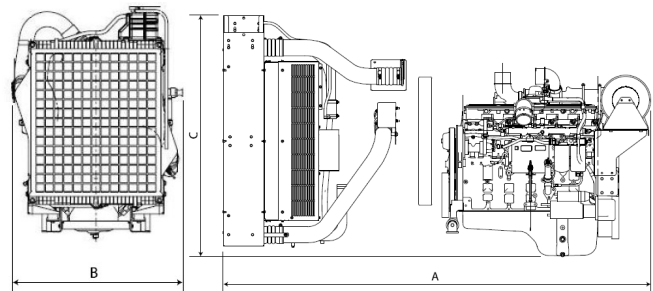

Fuel Consumption 1500 (50 Hz)

%	kWm	BHP	L/ph	US gal/ph
Standby Power				
100	310	415	75	19.8
Prime Power				
100	268	359	63	16.6
75	201	269	46	12.1
50	134	180	31	8.2
25	67	90	17	4.4
Continuous Power				
100	228	305	53	13.9

Fuel Consumption 1800 (60 Hz)

%	kWm	BHP	L/ph	US gal/ph
Standby Power				
100	355	476	89	23.6
Prime Power				
100	307	412	75	19.9
75	231	309	55	14.4
50	154	206	36	9.6
25	77	103	20	5.3
Continuous Power				
100	261	350	63	16.5

Cummins G-Drive Engines

Asia Pacific

10 Toh Guan Road
#07-01
TT International Tradepark
Singapore 608838
Phone 65 6417 2388
Fax 65 6417 2399

Europe, CIS, Middle

East and Africa
Manston Park Columbus Ave
Manston Ramsgate
Kent CT12 5BF, UK
Phone 44 1843 255000
Fax 44 1843 255902

Latin America

Rua Jati, 310, Cumbica
Guarulhos, SP 07180-900
Brazil
Phone 55 11 2186 4552
Fax 55 11 2186 4729

Mexico

Cummins S. de R.L. de C.V.
Eje 122 No. 200 Zona Industrial
San Luis Potosí, S.L.P. 78090
Mexico
Phone 52 444 870 6700
Fax 52 444 870 6811

North America

1400 73rd Avenue N.E.
Minneapolis, MN 55432
USA
Phone 1 763 574 5000
USA Toll-free 1 877 769 7669
Fax 1 763 574 5298

Ratings Definitions

Emergency Standby Power (ESP):

Applicable for supplying power to varying electrical load for the duration of power interruption of a reliable utility source. Emergency Standby Power (ESP) is in accordance with ISO 8528. Fuel Stop power in accordance with ISO 3046, AS 2789, DIN 6271 and BS 5514.

Limited-Time Running Power (LTP):

Applicable for supplying power to a constant electrical load for limited hours. Limited-Time Running Power (LTP) is in accordance with ISO 8528.

Prime Power (PRP):

Applicable for supplying power to varying electrical load for unlimited hours. Prime Power (PRP) is in accordance with ISO 8528. Ten percent overload capability is available in accordance with ISO 3046, AS 2789, DIN 6271 and BS 5514.

Base Load (Continuous) Power (COP):

Applicable for supplying power continuously to a constant electrical load for unlimited hours. Continuous Power (COP) is in accordance with ISO 8528, ISO 3046, AS 2789, DIN6271 and BS 5514.



STAMFORD[®]

HCI 434D/444D - Technical Data Sheet

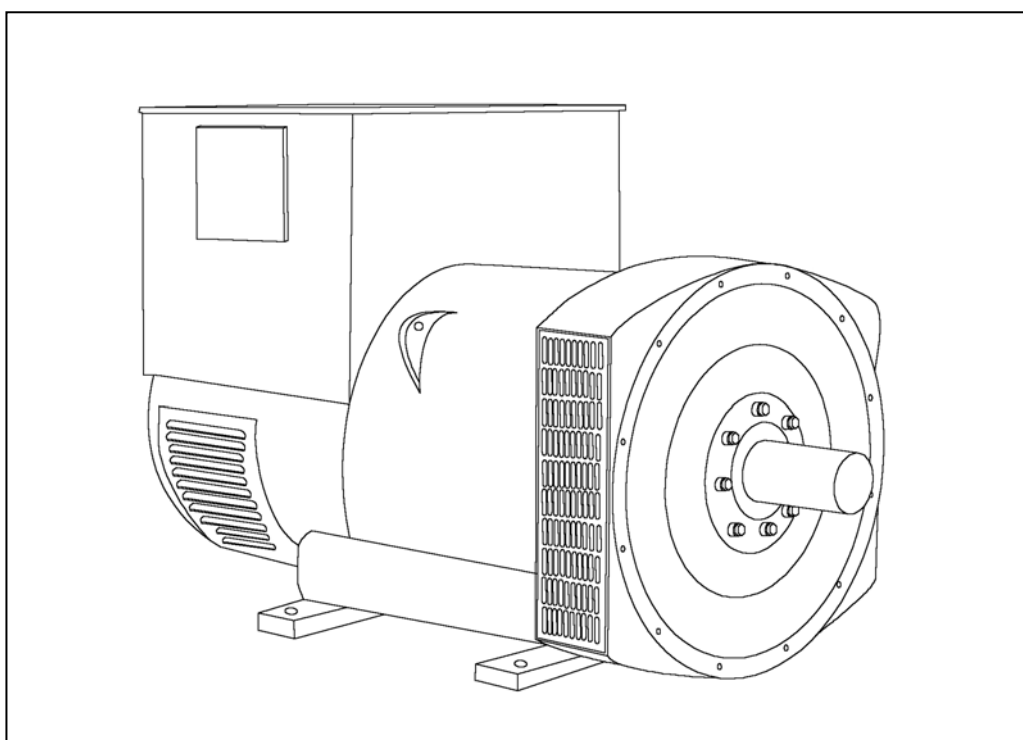

HCI434D/444D

SPECIFICATIONS & OPTIONS

STAMFORD

STANDARDS

Newage Stamford industrial generators meet the requirements of BS EN 60034 and the relevant section of other international standards such as BS5000, VDE 0530, NEMA MG1-32, IEC34, CSA C22.2-100, AS1359. Other standards and certifications can be considered on request.

VOLTAGE REGULATORS

AS440 AVR - STANDARD

With this self-excited system the main stator provides power via the Automatic Voltage Regulator (AVR) to the exciter stator. The high efficiency semi-conductors of the AVR ensure positive build-up from initial low levels of residual voltage.

The exciter rotor output is fed to the main rotor through a three-phase full-wave bridge rectifier. The rectifier is protected by a surge suppressor against surges caused, for example, by short circuit or out-of-phase paralleling.

The AS440 will support a range of electronic accessories, including a 'droop' Current Transformer (CT) to permit parallel operation with other ac generators.

MX341 AVR

This sophisticated AVR is incorporated into the Stamford Permanent Magnet Generator (PMG) control system.

The PMG provides power via the AVR to the main exciter, giving a source of constant excitation power independent of generator output. The main exciter output is then fed to the main rotor, through a full wave bridge, protected by a surge suppressor. The AVR has in-built protection against sustained over-excitation, caused by internal or external faults. This de-excites the machine after a minimum of 5 seconds.

An engine relief load acceptance feature can enable full load to be applied to the generator in a single step.

If three-phase sensing is required with the PMG system the MX321 AVR must be used.

We recommend three-phase sensing for applications with greatly unbalanced or highly non-linear loads.

MX321 AVR

The most sophisticated of all our AVRs combines all the features of the MX341 with, additionally, three-phase rms sensing, for improved regulation and performance.

Over voltage protection is built-in and short circuit current level adjustments is an optional facility.

WINDINGS & ELECTRICAL PERFORMANCE

All generator stators are wound to 2/3 pitch. This eliminates triplen (3rd, 9th, 15th ...) harmonics on the voltage waveform and is found to be the optimum design for trouble-free supply of non-linear loads. The 2/3 pitch design avoids excessive neutral currents sometimes seen with higher winding pitches, when in parallel with the mains. A fully connected damper winding reduces oscillations during paralleling. This winding, with the 2/3 pitch and carefully selected pole and tooth designs, ensures very low waveform distortion.

TERMINALS & TERMINAL BOX

Standard generators are 3-phase reconnectable with 12 ends brought out to the terminals, which are mounted on a cover at the non-drive end of the generator. A sheet steel terminal box contains the AVR and provides ample space for the customers' wiring and gland arrangements. It has removable panels for easy access.

SHAFT & KEYS

All generator rotors are dynamically balanced to better than BS6861:Part 1 Grade 2.5 for minimum vibration in operation. Two bearing generators are balanced with a half key.

INSULATION/IMPREGNATION

The insulation system is class 'H'.

All wound components are impregnated with materials and processes designed specifically to provide the high build required for static windings and the high mechanical strength required for rotating components.

QUALITY ASSURANCE

Generators are manufactured using production procedures having a quality assurance level to BS EN ISO 9001.

The stated voltage regulation may not be maintained in the presence of certain radio transmitted signals. Any change in performance will fall within the limits of Criteria 'B' of EN 61000-6-2:2001. At no time will the steady-state voltage regulation exceed 2%.

NB Continuous development of our products entitles us to change specification details without notice, therefore they must not be regarded as binding.

Front cover drawing typical of product range.

HCI434D/444D



WINDING 311

CONTROL SYSTEM	SEPARATELY EXCITED BY P.M.G.							
A.V.R.	MX321	MX341						
VOLTAGE REGULATION	± 0.5 %	± 1.0 %	With 4% ENGINE GOVERNING					
SUSTAINED SHORT CIRCUIT	REFER TO SHORT CIRCUIT DECREMENT CURVES (page 7)							
CONTROL SYSTEM	SELF EXCITED							
A.V.R.	AS440							
VOLTAGE REGULATION	± 1.0 %	With 4% ENGINE GOVERNING						
SUSTAINED SHORT CIRCUIT	WILL NOT SUSTAIN A SHORT CIRCUIT							
INSULATION SYSTEM	CLASS H							
PROTECTION	IP23							
RATED POWER FACTOR	0.8							
STATOR WINDING	DOUBLE LAYER LAP							
WINDING PITCH	TWO THIRDS							
WINDING LEADS	12							
STATOR WDG. RESISTANCE	0.0124 Ohms PER PHASE AT 22°C SERIES STAR CONNECTED							
ROTOR WDG. RESISTANCE	1.05 Ohms at 22°C							
EXCITER STATOR RESISTANCE	18 Ohms at 22°C							
EXCITER ROTOR RESISTANCE	0.068 Ohms PER PHASE AT 22°C							
R.F.I. SUPPRESSION	BS EN 61000-6-2 & BS EN 61000-6-4, VDE 0875G, VDE 0875N. refer to factory for others							
WAVEFORM DISTORTION	NO LOAD < 1.5% NON-DISTORTING BALANCED LINEAR LOAD < 5.0%							
MAXIMUM OVERSPEED	2250 Rev/Min							
BEARING DRIVE END	BALL. 6317 (ISO)							
BEARING NON-DRIVE END	BALL. 6314 (ISO)							
	1 BEARING				2 BEARING			
WEIGHT COMP. GENERATOR	940 kg				950 kg			
WEIGHT WOUND STATOR	415 kg				415 kg			
WEIGHT WOUND ROTOR	361 kg				338 kg			
WR ² INERTIA	4.0771 kgm ²				3.8783 kgm ²			
SHIPPING WEIGHTS in a crate	1010 kg				1010 kg			
PACKING CRATE SIZE	155 x 87 x 107(cm)				155 x 87 x 107(cm)			
	50 Hz				60 Hz			
TELEPHONE INTERFERENCE	THF<2%				TIF<50			
COOLING AIR	0.8 m ³ /sec 1700 cfm				0.99 m ³ /sec 2100 cfm			
VOLTAGE SERIES STAR	380/220	400/231	415/240	440/254	416/240	440/254	460/266	480/277
VOLTAGE PARALLEL STAR	190/110	200/115	208/120	220/127	208/120	220/127	230/133	240/138
VOLTAGE SERIES DELTA	220/110	230/115	240/120	254/127	240/120	254/127	266/133	277/138
KVA BASE RATING FOR REACTANCE VALUES	300	300	300	290	340	360	375	375
X _d DIR. AXIS SYNCHRONOUS	3.16	2.85	2.65	2.28	3.56	3.37	3.21	2.95
X' _d DIR. AXIS TRANSIENT	0.20	0.18	0.17	0.15	0.22	0.21	0.20	0.18
X'' _d DIR. AXIS SUBTRANSIENT	0.14	0.13	0.12	0.10	0.15	0.14	0.14	0.12
X _q QUAD. AXIS REACTANCE	2.66	2.40	2.23	1.92	3.05	2.89	2.75	2.53
X'' _q QUAD. AXIS SUBTRANSIENT	0.39	0.36	0.33	0.28	0.40	0.38	0.36	0.33
X _L LEAKAGE REACTANCE	0.07	0.06	0.06	0.05	0.09	0.09	0.08	0.07
X ₂ NEGATIVE SEQUENCE	0.26	0.24	0.22	0.19	0.28	0.27	0.25	0.23
X ₀ ZERO SEQUENCE	0.10	0.09	0.08	0.07	0.10	0.09	0.09	0.08
REACTANCES ARE SATURATED				VALUES ARE PER UNIT AT RATING AND VOLTAGE INDICATED				
T' _d TRANSIENT TIME CONST.	0.08s							
T'' _d SUB-TRANSTIME CONST.	0.019s							
T' _{do} O.C. FIELD TIME CONST.	1.7s							
T _a ARMATURE TIME CONST.	0.018s							
SHORT CIRCUIT RATIO	1/X _d							

50
Hz

HCI434D/444D

STAMFORD

Winding 311

THREE PHASE EFFICIENCY CURVES

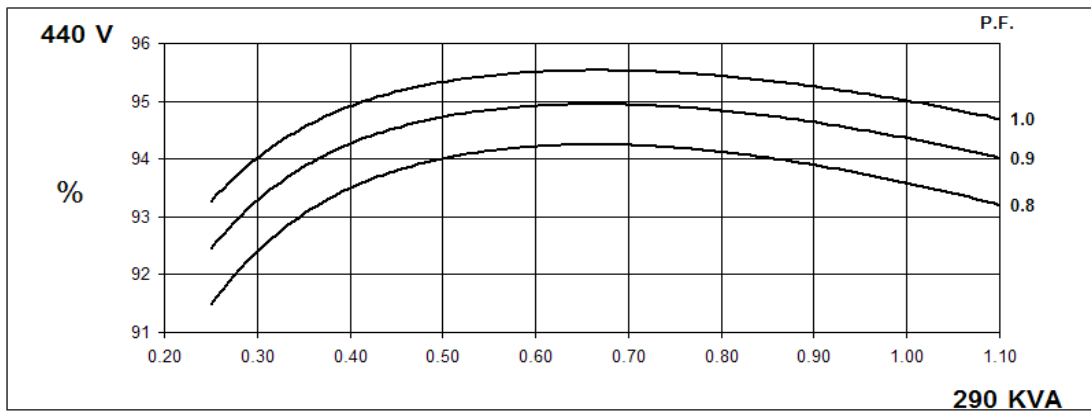
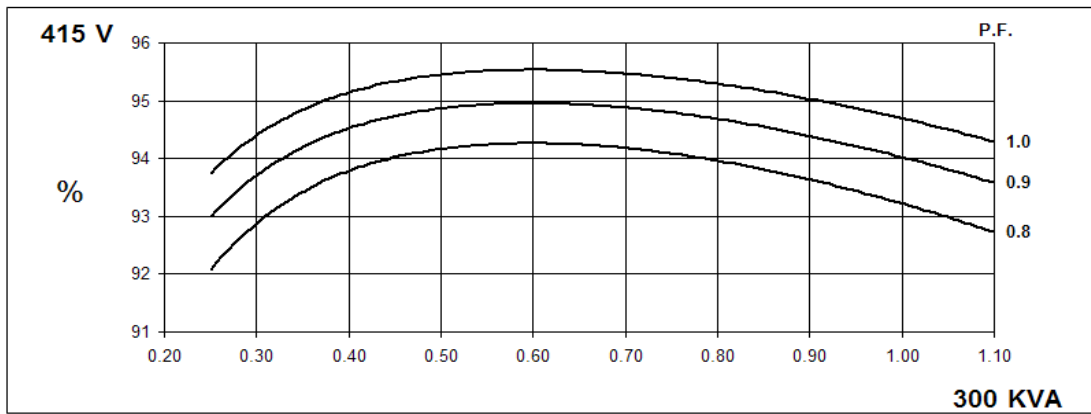
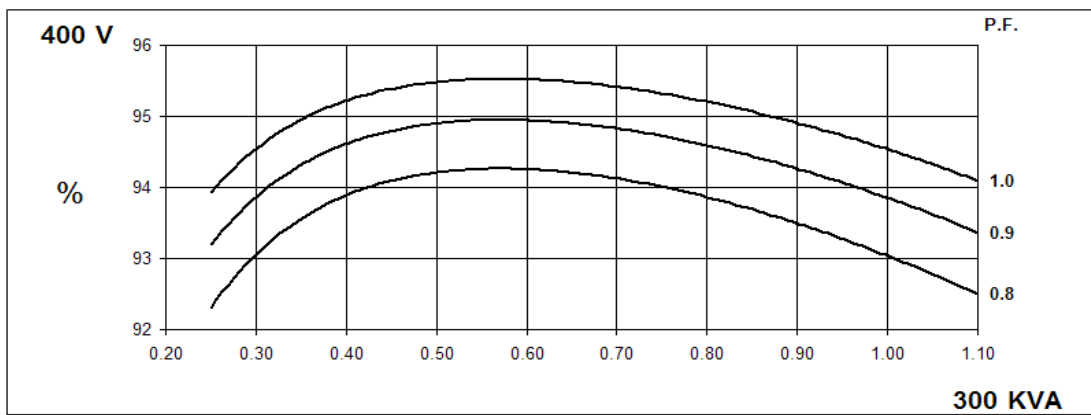
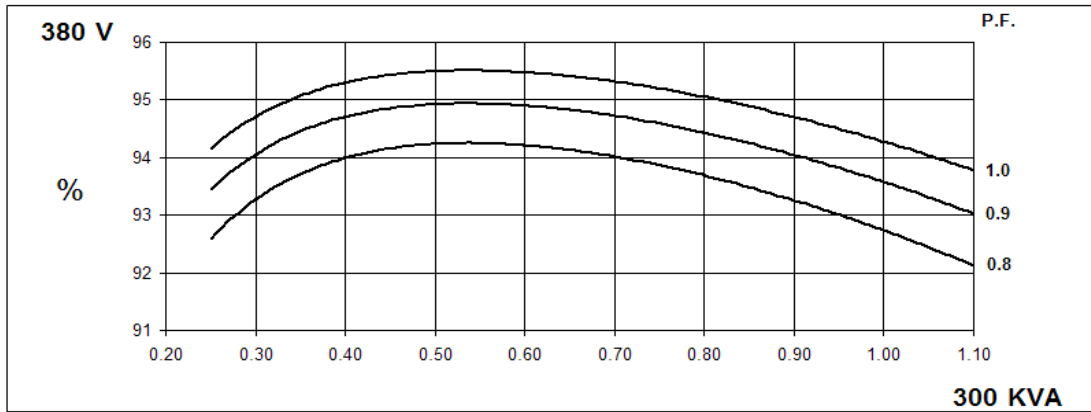

60
Hz

HCI434D/444D

STAMFORD

Winding 311

THREE PHASE EFFICIENCY CURVES

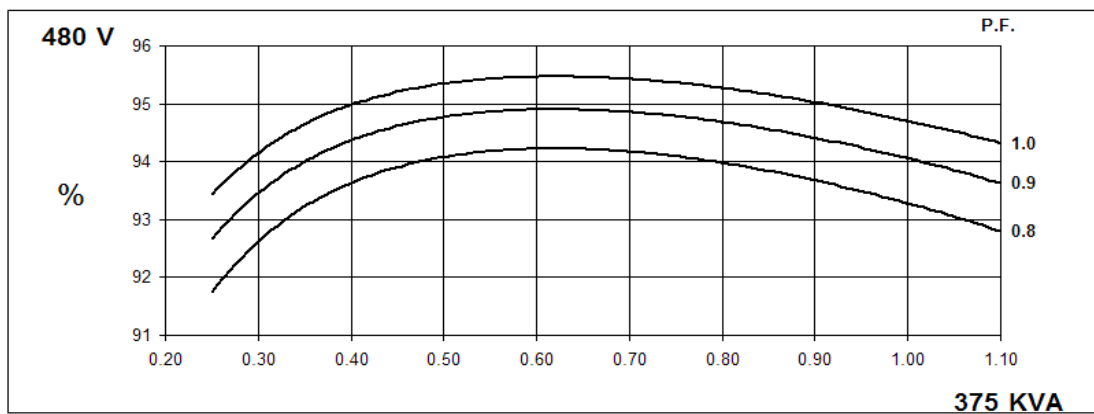
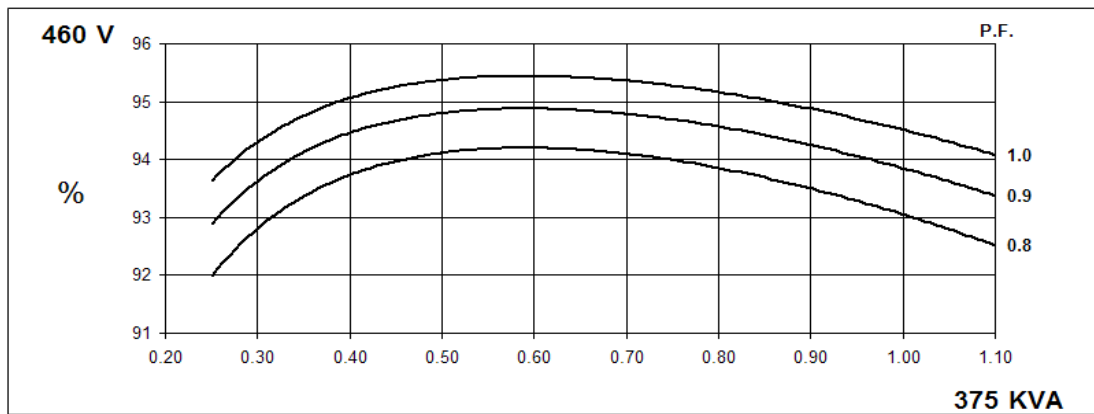
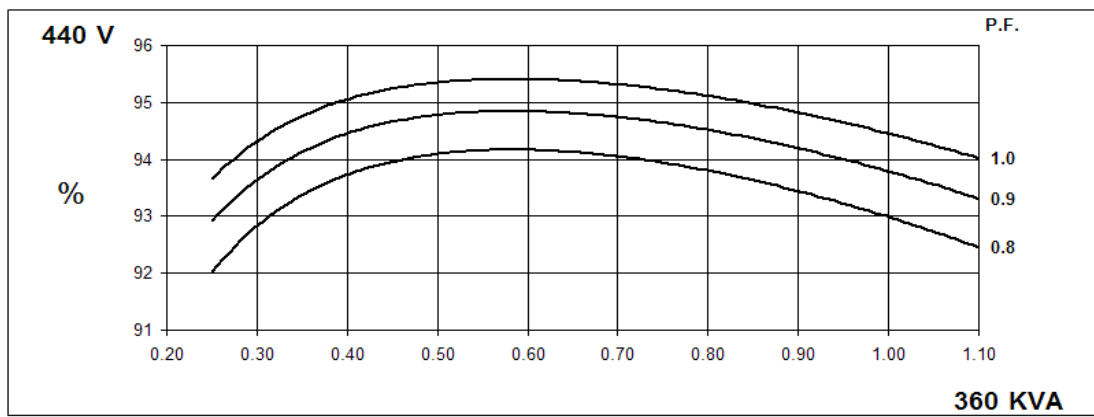
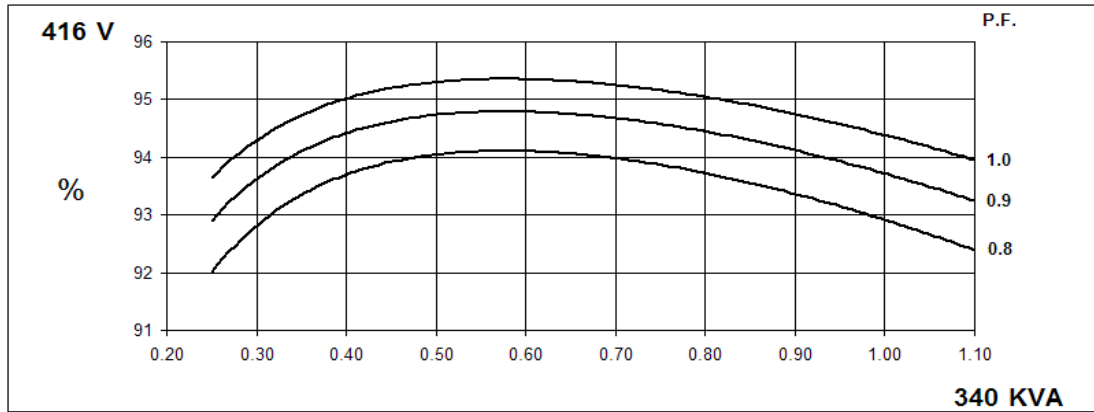

Locked Rotor Motor Starting Curve

50
Hz

MX

SX

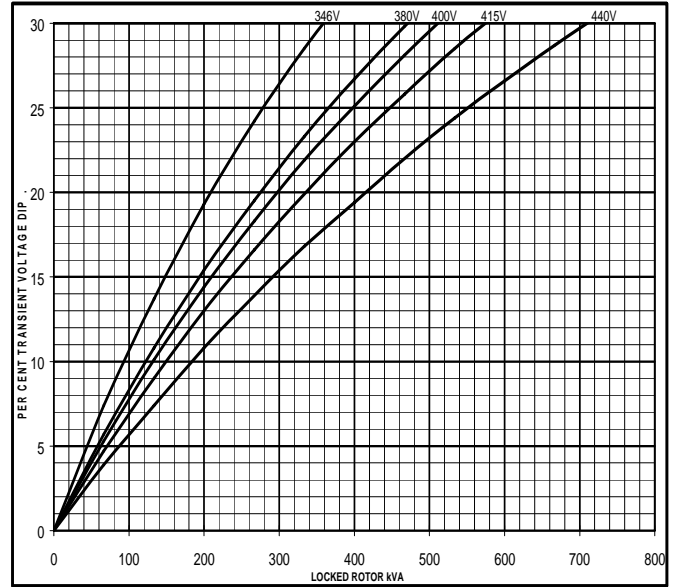
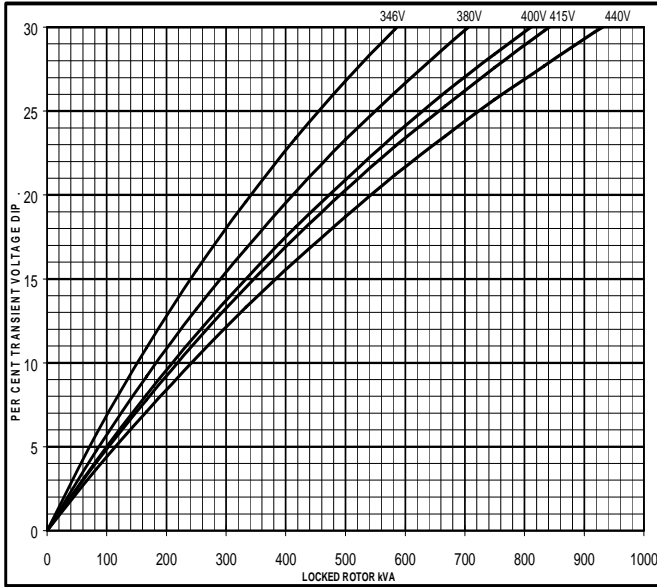

60
Hz

MX

SX

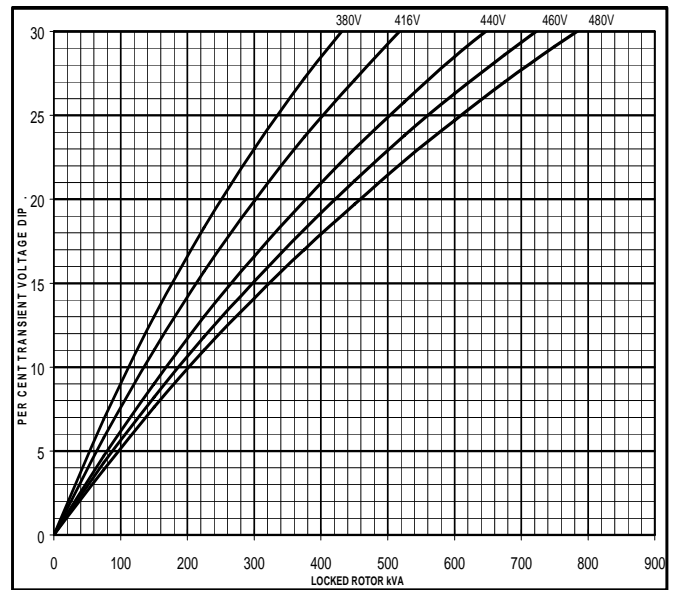
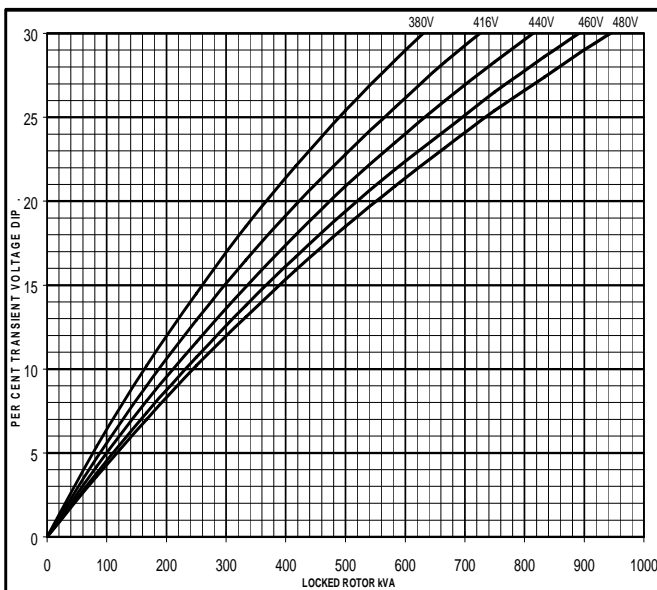

**Three-phase Short Circuit Decrement Curve. No-load Excitation at Rated Speed
Based on star (wye) connection.**

**50
Hz**

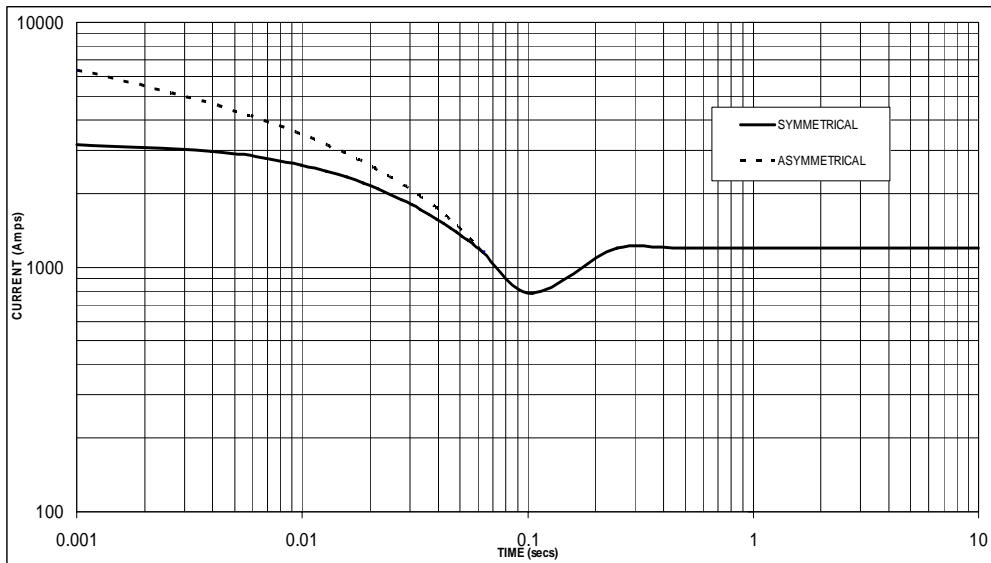

Sustained Short Circuit = 1,200 Amps

**60
Hz**

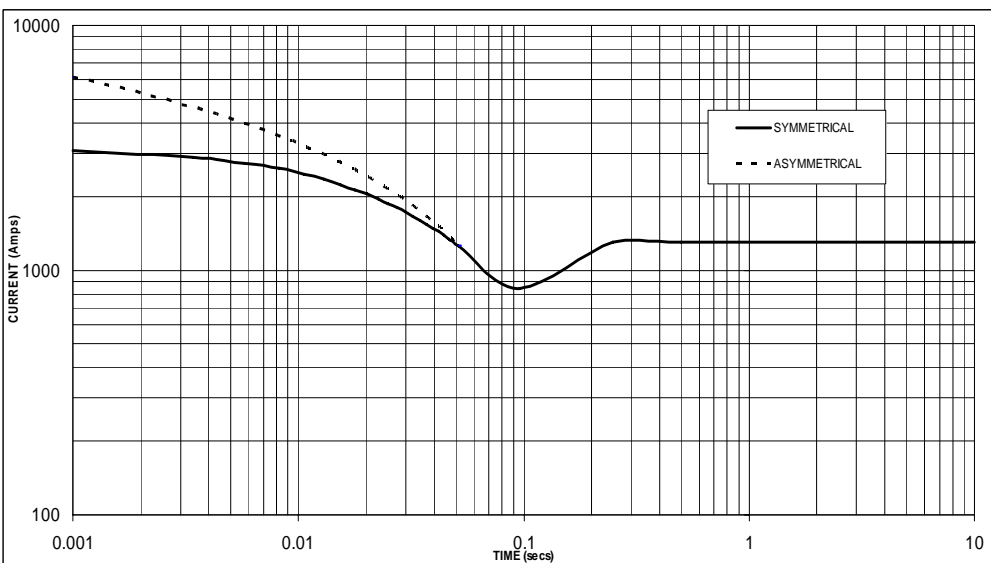

Sustained Short Circuit = 1,300 Amps

Note 1

The following multiplication factors should be used to adjust the values from curve between time 0.001 seconds and the minimum current point in respect of nominal operating voltage :

50Hz		60Hz	
Voltage	Factor	Voltage	Factor
380v	X 1.00	416v	X 1.00
400v	X 1.05	440v	X 1.06
415v	X 1.09	460v	X 1.10
440v	X 1.16	480v	X 1.15

The sustained current value is constant irrespective of voltage level

Note 2

The following multiplication factor should be used to convert the values calculated in accordance with NOTE 1 to those applicable to the various types of short circuit :

	3-phase	2-phase L-L	1-phase L-N
Instantaneous	x 1.00	x 0.87	x 1.30
Minimum	x 1.00	x 1.80	x 3.20
Sustained	x 1.00	x 1.50	x 2.50
Max. sustained duration	10 sec.	5 sec.	2 sec.

All other times are unchanged

Note 3

Curves are drawn for Star (Wye) connected machines. For other connection the following multipliers should be applied to current values as shown :

HCI434D/444D

Winding 311 / 0.8 Power Factor

STAMFORD

RATINGS

Class - Temp Rise	Cont. F - 105/40°C				Cont. H - 125/40°C				Standby - 150/40°C				Standby - 163/27°C				
50 Hz	Series Star (V)	380	400	415	440	380	400	415	440	380	400	415	440	380	400	415	440
	Parallel Star (V)	190	200	208	220	190	200	208	220	190	200	208	220	190	200	208	220
	Series Delta (V)	220	230	240	254	220	230	240	254	220	230	240	254	220	230	240	254
kVA	280	280	280	270	300	300	300	290	320	320	320	310	330	330	330	320	
kW	224	224	224	216	240	240	240	232	256	256	256	248	264	264	264	256	
Efficiency (%)	93.1	93.4	93.5	93.8	92.7	93.0	93.2	93.6	92.3	92.7	92.9	93.3	92.1	92.5	92.7	93.2	
kW Input	241	240	240	230	259	258	258	248	277	276	276	266	287	285	285	275	

60 Hz	Series Star (V)	416	440	460	480	416	440	460	480	416	440	460	480	416	440	460	480
	Parallel Star (V)	208	220	230	240	208	220	230	240	208	220	230	240	208	220	230	240
	Series Delta (V)	240	254	266	277	240	254	266	277	240	254	266	277	240	254	266	277
kVA	315	335	345	345	340	360	375	375	365	385	400	400	375	395	415	415	
kW	252	268	276	276	272	288	300	300	292	308	320	320	300	316	332	332	
Efficiency (%)	93.3	93.3	93.4	93.6	92.9	93.0	93.1	93.3	92.5	92.6	92.7	93.0	92.4	92.5	92.5	92.8	
kW Input	270	287	296	295	293	310	322	322	316	333	345	344	325	342	359	358	

DIMENSIONS

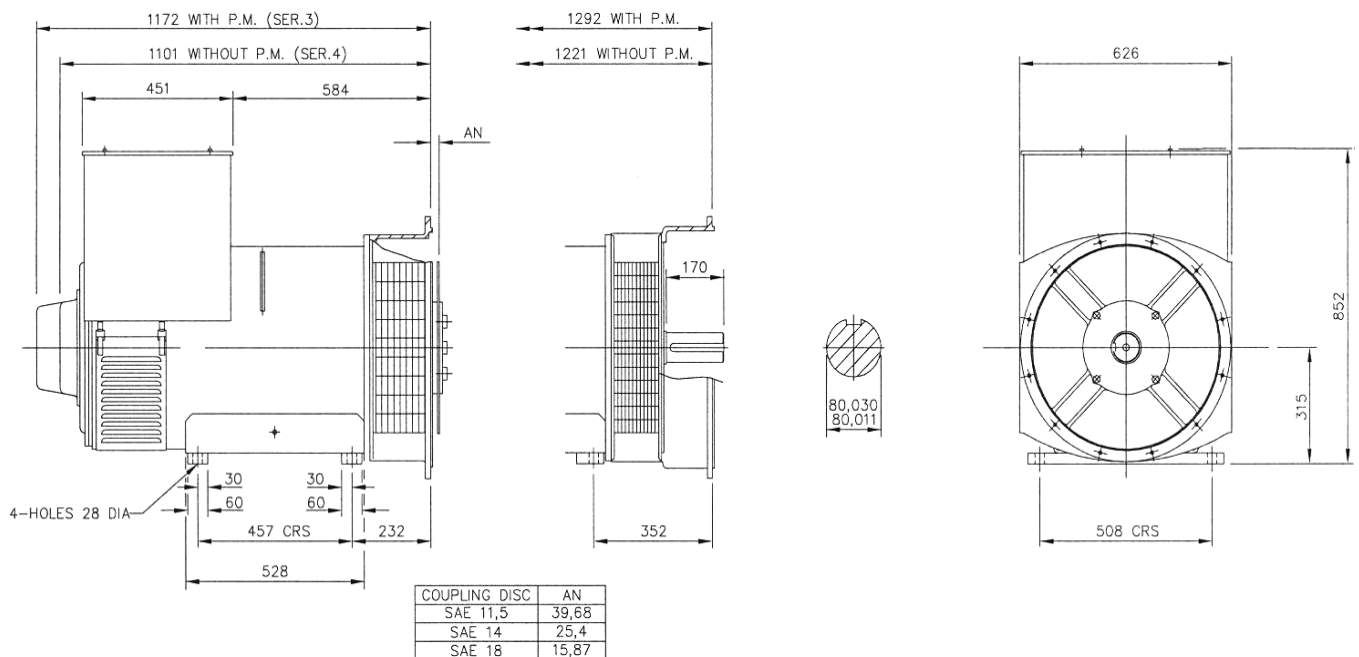

STAMFORD

Barnack Road • Stamford • Lincolnshire • PE9 2NB
Tel: 00 44 (0)1780 484000 • Fax: 00 44 (0)1780 484100

QSL9-G3

Emissions Compliance:
EU Stage IIIA at 50 Hz
EPA NSPS Stationary Emergency Tier 3

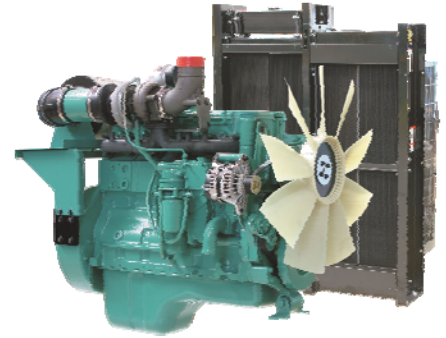

> Specification sheet



Our energy working for you.™

Description

Cummins QSL engines are built to deliver heavy-duty performance. Full-authority electronic engine controls combine with the high-pressure fuel system, 24-valve design and centred injectors for one of the highest power-to-weight ratios in its class. At the same time, the QSL delivers better fuel economy, has better cold starting capability and is up to 50% quieter in operation than its predecessors.



This engine has been built to comply with CE certification.



This engine has been designed in facilities certified to ISO9001 and manufactured in facilities certified to ISO9001 or ISO9002.

Features

Common Rail Fuel System and Controls - Bosch high pressure common rail (HPCR) - Optimize engine performance to provide seamless integration and advanced diagnostics and programming options.

Holset HX40 Turbo charging – Waste-gated design optimizes transient response.

Integrated Block Design - Integrated fluid circuits replace hoses and eliminate potential leaks.

24-Valve Cylinder Head – Four valves per cylinder for increased power with faster response & fuel economy.

Coolpac Integrated Design - Products are supplied complete with cooling package and air cleaner kit for a complete power package. Each component has been specifically developed and rigorously tested for G-Drive products, ensuring high performance, durability and reliability.

Service and Support - G-Drive products are backed by an uncompromising level of technical support and after sales service, delivered through a world class service network.

1500 rpm (50 Hz Ratings)

Gross Engine Output			Net Engine Output			Typical Generator Set Output					
Standby	Prime	Base	Standby	Prime	Base	Standby (ESP)		Prime (PRP)		Base (COP)	
kWm/BHP			kWm/BHP			kWe	kVA	kWe	kVA	kWe	kVA
257/345	227/305	193/259	244/327	217/291	183/245	220	275	200	250	170	213

1800 rpm (60 Hz Ratings)

Gross Engine Output			Net Engine Output			Typical Generator Set Output					
Standby	Prime	Base	Standby	Prime	Base	Standby (ESP)		Prime (PRP)		Base (COP)	
kWm/BHP			kWm/BHP			kWe	kVA	kWe	kVA	kWe	kVA
297/399	262/352	178/238	280/375	248/332	164/219	250	313	227	284	152	190



General Engine Data

Type	4 cycle, in-line, Turbo Charged, Air-cooled
Bore mm	114 mm (4.5in.)
Stroke mm	145 mm (5.7in.)
Displacement Litre	8.8 litre (543 in. ³)
Cylinder Block	Cast iron, 6 cylinder
Battery Charging Alternator	70 amps
Starting Voltage	24 volt, negative ground
Fuel System	Direct injection
Fuel Filter	Spin-on fuel filters with water separator
Lube Oil Filter Type(s)	Spin-on full flow filter
Lube Oil Capacity (l)	26.5
Flywheel Dimensions	SAE1/14

Coolpac Performance Data

Cooling System Design	Air-Air Charge Cooled
Coolant Ratio	50% ethylene glycol; 50% water
Coolant Capacity (l)	15.0
Limiting Ambient Temp.** (°C)	50 (50Hz); 55 (60Hz)
Fan Power (kWm)	10 (50Hz); 11 (60Hz)
Cooling System Air Flow (m ³ /s)**	7.9 (50Hz); 8 (60Hz)
Air Cleaner Type	Light duty dry replaceable element with restriction indicator

** @ 13 mm H₂O

Weight & Dimensions

Length	Width	Height	Weight (dry)
mm	mm	mm	kg
1624	1064	1463	861

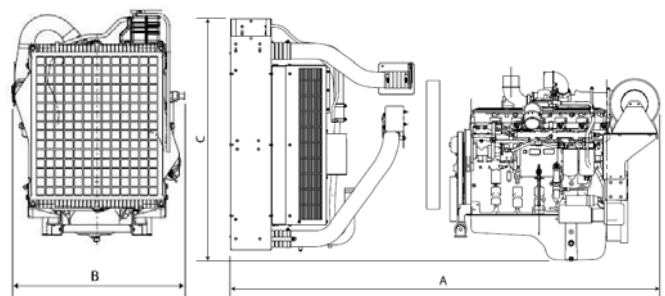

Fuel Consumption 1500 (50 Hz)

%	kWm	BHP	L/ph	US gal/ph
Standby Power				
100	257	345	66	17.3
Prime Power				
100	227	305	59	15.6
75	170	228	49	13.0
50	114	152	34	8.9
25	57	76	18	4.7
Continuous Power				
100	193	259	53	14.1

Fuel Consumption 1800 (60 Hz)

%	kWm	BHP	L/ph	US gal/ph
Standby Power				
100	297	399	77	20.4
Prime Power				
100	262	352	70	18.5
75	197	264	58	15.2
50	131	176	41	10.8
25	66	88	21	5.6
Continuous Power				
100	178	238	53	14.1

Cummins G-Drive Engines

Asia Pacific

10 Toh Guan Road
#07-01
TT International Tradepark
Singapore 608838
Phone 65 6417 2388
Fax 65 6417 2399

Europe, CIS, Middle

East and Africa
Manston Park Columbus Ave
Manston Ramsgate
Kent CT12 5BF. UK
Phone 44 1843 255000
Fax 44 1843 255902

Latin America

Rua Jati, 310, Cumbica
Guarulhos, SP 07180-900
Brazil
Phone 55 11 2186 4552
Fax 55 11 2186 4729

Mexico

Cummins S. de R.L. de C.V.
Eje 122 No. 200 Zona Industrial
San Luis Potosí, S.L.P. 78090
Mexico
Phone 52 444 870 6700
Fax 52 444 870 6811

North America

1400 73rd Avenue N.E.
Minneapolis, MN 55432
USA
Phone 1 763 574 5000
USA Toll-free 1 877 769 7669
Fax 1 763 574 5298

Ratings Definitions

Emergency Standby Power (ESP):

Applicable for supplying power to varying electrical load for the duration of power interruption of a reliable utility source. Emergency Standby Power (ESP) is in accordance with ISO 8528. Fuel Stop power in accordance with ISO 3046, AS 2789, DIN 6271 and BS 5514.

Limited-Time Running Power (LTP):

Applicable for supplying power to a constant electrical load for limited hours. Limited-Time Running Power (LTP) is in accordance with ISO 8528.

Prime Power (PRP):

Applicable for supplying power to varying electrical load for unlimited hours. Prime Power (PRP) is in accordance with ISO 8528. Ten percent overload capability is available in accordance with ISO 3046, AS 2789, DIN 6271 and BS 5514.

Base Load (Continuous) Power (COP):

Applicable for supplying power continuously to a constant electrical load for unlimited hours. Continuous Power (COP) is in accordance with ISO 8528, ISO 3046, AS 2789, DIN6271 and BS 5514.

UCDI274K - Technical Data Sheet

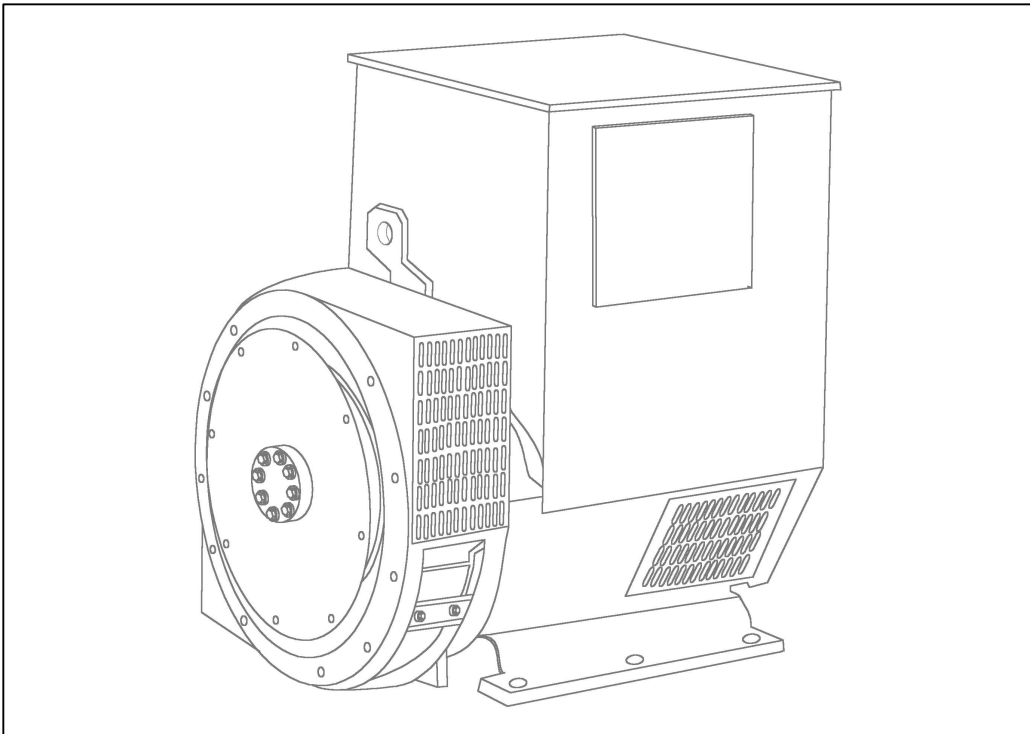

UCDI274K

SPECIFICATIONS & OPTIONS



STANDARDS

Newage Stamford industrial generators meet the requirements of BS EN 60034 and the relevant section of other international standards such as BS5000, VDE 0530, NEMA MG1-32, IEC34, CSA C22.2-100, AS1359. Other standards and certifications can be considered on request.

VOLTAGE REGULATORS

SX460 AVR - STANDARD

With this self excited control system the main stator supplies power via the Automatic Voltage Regulator (AVR) to the exciter stator. The high efficiency semiconductors of the AVR ensure positive build-up from initial low levels of residual voltage.

The exciter rotor output is fed to the main rotor through a three phase full wave bridge rectifier. This rectifier is protected by a surge suppressor against surges caused, for example, by short circuit.

SX440 AVR

With this self-excited system the main stator provides power via the AVR to the exciter stator. The high efficiency semi-conductors of the AVR ensure positive build-up from initial low levels of residual voltage.

The exciter rotor output is fed to the main rotor through a three-phase full-wave bridge rectifier. The rectifier is protected by a surge suppressor against surges caused, for example, by short circuit or out-of-phase paralleling.

The SX440 will support a range of electronic accessories, including a 'droop' Current Transformer (CT) to permit parallel operation with other ac generators.

If 3-phase sensing is required with the self-excited system, the SX421 AVR must be used.

SX421AVR

This AVR also operates in a self-excited system. It combines all the features of the SX440 with, additionally, three-phase rms sensing for improved regulation and performance. Over voltage protection is provided via a separate circuit breaker. An engine relief load acceptance feature is built in as standard.

MX341 AVR

This sophisticated AVR is incorporated into the Stamford Permanent Magnet Generator (PMG) control system.

The PMG provides power via the AVR to the main exciter, giving a source of constant excitation power independent of generator output. The main exciter output is then fed to the main rotor, through a full wave bridge, protected by a surge suppressor. The AVR has in-built protection against sustained over-excitation, caused by internal or external faults. This de-excites the machine after a minimum of 5 seconds.

An engine relief load acceptance feature can enable full load to be applied to the generator in a single step.

If three-phase sensing is required with the PMG system the MX321 AVR must be used.

We recommend three-phase sensing for applications with greatly unbalanced or highly non-linear loads.

MX321 AVR

The most sophisticated of all our AVRs combines all the features of the MX341 with, additionally, three-phase rms sensing, for improved regulation and performance.

Over voltage protection is built-in and short circuit current level adjustments is an optional facility.

WINDINGS & ELECTRICAL PERFORMANCE

All generator stators are wound to 2/3 pitch. This eliminates triplen (3rd, 9th, 15th ...) harmonics on the voltage waveform and is found to be the optimum design for trouble-free supply of non-linear loads. The 2/3 pitch design avoids excessive neutral currents sometimes seen with higher winding pitches, when in parallel with the mains. A fully connected damper winding reduces oscillations during paralleling. This winding, with the 2/3 pitch and carefully selected pole and tooth designs, ensures very low waveform distortion.

TERMINALS & TERMINAL BOX

Standard generators are 3-phase reconnectable with 12 ends brought out to the terminals, which are mounted on a cover at the non-drive end of the generator. A sheet steel terminal box contains the AVR and provides ample space for the customers' wiring and gland arrangements. It has removable panels for easy access.

SHAFT & KEYS

All generator rotors are dynamically balanced to better than BS6861:Part 1 Grade 2.5 for minimum vibration in operation.

INSULATION/IMPREGNATION

The insulation system is class 'H'.

All wound components are impregnated with materials and processes designed specifically to provide the high build required for static windings and the high mechanical strength required for rotating components.

QUALITY ASSURANCE

Generators are manufactured using production procedures having a quality assurance level to BS EN ISO 9001.

The stated voltage regulation may not be maintained in the presence of certain radio transmitted signals. Any change in performance will fall within the limits of Criteria 'B' of EN 61000-6-2:2001. At no time will the steady-state voltage regulation exceed 2%.

NB Continuous development of our products entitles us to change specification details without notice, therefore they must not be regarded as binding.

Front cover drawing typical of product range.

UCDI274K
WINDING 311

CONTROL SYSTEM	SEPARATELY EXCITED BY P.M.G.							
A.V.R.	MX321	MX341						
VOLTAGE REGULATION	± 0.5 %	± 1.0 %	With 4% ENGINE GOVERNING					
SUSTAINED SHORT CIRCUIT	REFER TO SHORT CIRCUIT DECREMENT CURVES (page 7)							
CONTROL SYSTEM	SELF EXCITED							
A.V.R.	SX460	SX440	SX421					
VOLTAGE REGULATION	± 1.5 %	± 1.0 %	± 0.5 %	With 4% ENGINE GOVERNING				
SUSTAINED SHORT CIRCUIT	SERIES 4 CONTROL DOES NOT SUSTAIN A SHORT CIRCUIT CURRENT							
INSULATION SYSTEM	CLASS H							
PROTECTION	IP23							
RATED POWER FACTOR	0.8							
STATOR WINDING	DOUBLE LAYER CONCENTRIC							
WINDING PITCH	TWO THIRDS							
WINDING LEADS	12							
STATOR WDG. RESISTANCE	0.0126 Ohms PER PHASE AT 22°C SERIES STAR CONNECTED							
ROTOR WDG. RESISTANCE	2.08 Ohms at 22°C							
EXCITER STATOR RESISTANCE	20 Ohms at 22°C							
EXCITER ROTOR RESISTANCE	0.091 Ohms PER PHASE AT 22°C							
R.F.I. SUPPRESSION	BS EN 61000-6-2 & BS EN 61000-6-4, VDE 0875G, VDE 0875N. refer to factory for others							
WAVEFORM DISTORTION	NO LOAD < 1.5% NON-DISTORTING BALANCED LINEAR LOAD < 5.0%							
MAXIMUM OVERSPEED	2250 Rev/Min							
BEARING NON-DRIVE END	BALL. 6310-2RS (ISO)							
WEIGHT COMP. GENERATOR	727 kg							
WEIGHT WOUND STATOR	304 kg							
WEIGHT WOUND ROTOR	272.6 kg							
WR ² INERTIA	2.3934 kgm ²							
SHIPPING WEIGHTS in a crate	740 kg							
PACKING CRATE SIZE	123 x 67 x 103 (cm)							
	50 Hz				60 Hz			
TELEPHONE INTERFERENCE	THF<2%				TIF<50			
COOLING AIR	0.58 m ³ /sec 1230 cfm				0.69 m ³ /sec 1463 cfm			
VOLTAGE SERIES STAR (Y)	380/220	400/231	415/240	440/254	416/240	440/254	460/266	480/277
VOLTAGE PARALLEL STAR (Y)	190/110	200/115	208/120	220/127	208/120	220/127	230/133	240/138
VOLTAGE SERIES DELTA	220/110	230/115	240/120	254/127	240/120	254/127	266/133	277/138
KVA BASE RATING FOR REACTANCE VALUES	250	250	250	n/a	291	299	312.5	312.5
X _d DIR. AXIS SYNCHRONOUS	2.825	2.550	2.369	-	3.161	2.903	2.776	2.550
X' _d DIR. AXIS TRANSIENT	0.132	0.119	0.111	-	0.148	0.136	0.130	0.119
X'' _d DIR. AXIS SUBTRANSIENT	0.086	0.078	0.072	-	0.097	0.089	0.085	0.078
X _q QUAD. AXIS REACTANCE	1.263	1.140	1.059	-	1.413	1.298	1.241	1.140
X'' _q QUAD. AXIS SUBTRANSIENT	0.152	0.137	0.127	-	0.170	0.156	0.149	0.137
X _L LEAKAGE REACTANCE	0.066	0.060	0.056	-	0.074	0.068	0.065	0.060
X ₂ NEGATIVE SEQUENCE	0.120	0.108	0.100	-	0.134	0.123	0.118	0.108
X ₀ ZERO SEQUENCE	0.022	0.020	0.019	-	0.025	0.023	0.022	0.020
REACTANCES ARE SATURATED				VALUES ARE PER UNIT AT RATING AND VOLTAGE INDICATED				
T' _d TRANSIENT TIME CONST.	0.049 s							
T'' _d SUB-TRANSTIME CONST.	0.02 s							
T' _{do} O.C. FIELD TIME CONST.	1.27 s							
T _a ARMATURE TIME CONST.	0.018 s							
SHORT CIRCUIT RATIO	1/X _d							

**50
Hz**

UCDI274K
Winding 311



THREE PHASE EFFICIENCY CURVES

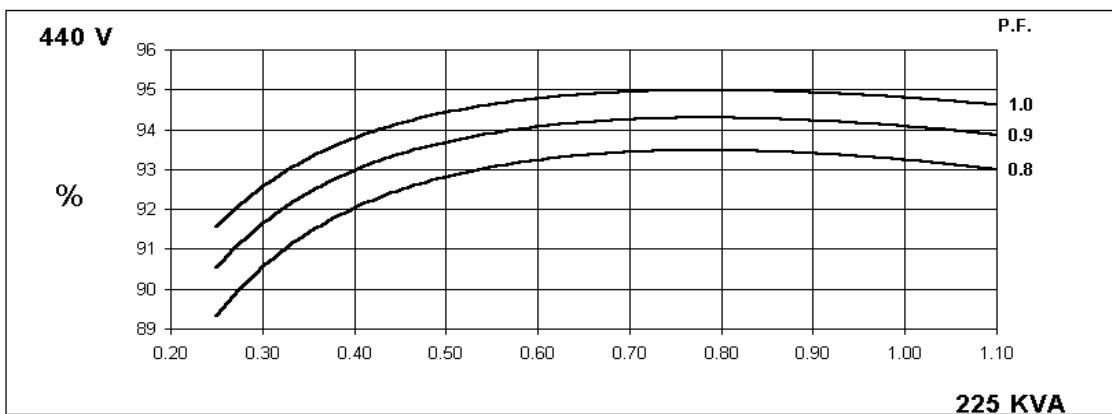
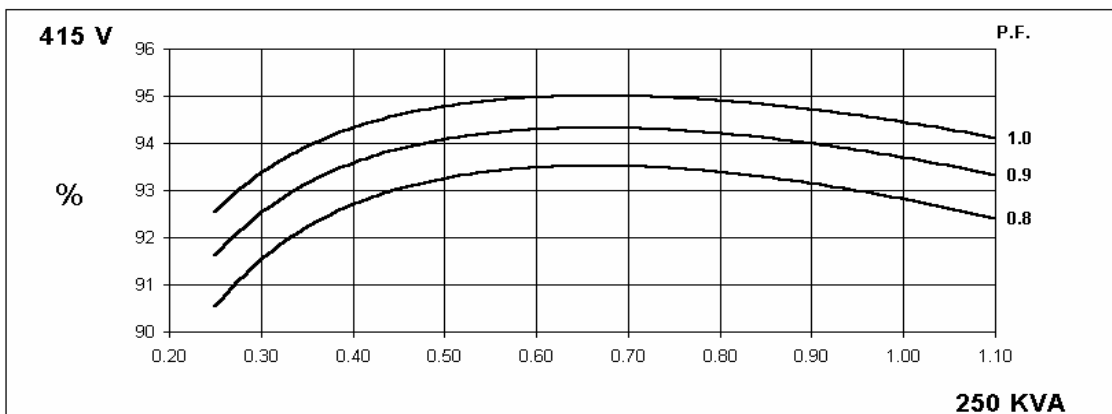
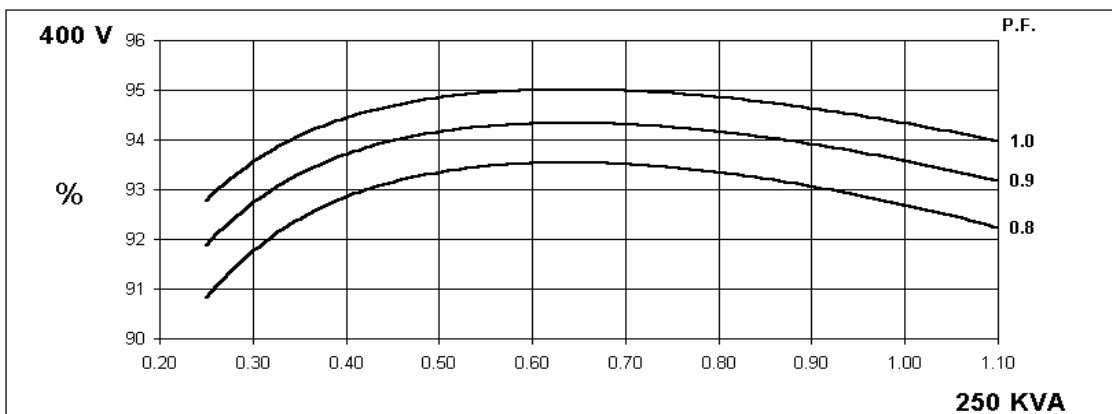
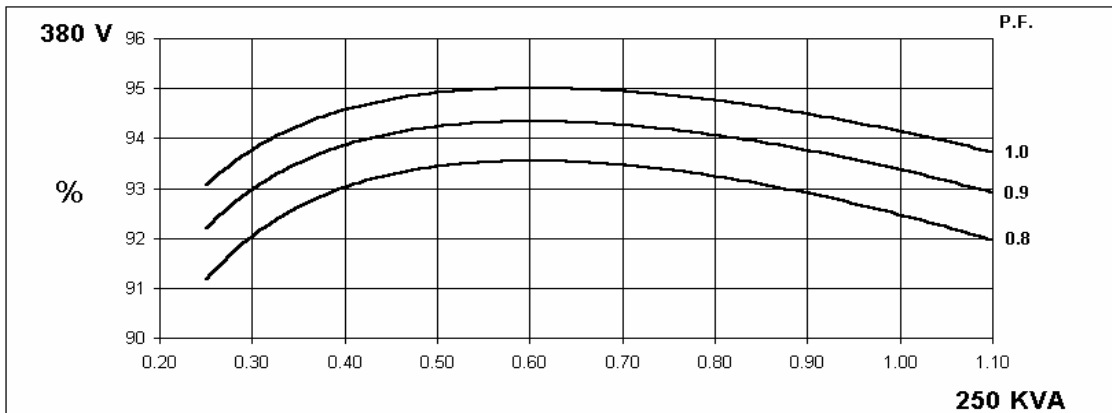

THREE PHASE EFFICIENCY CURVES

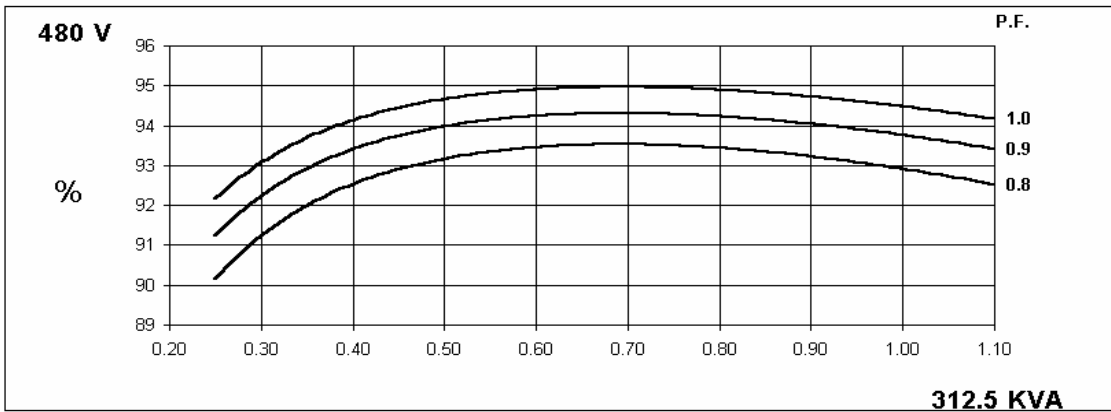
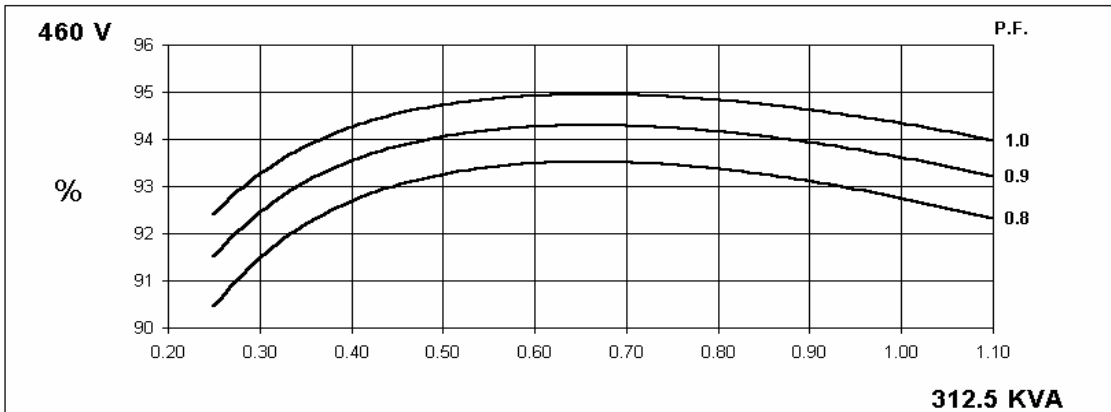
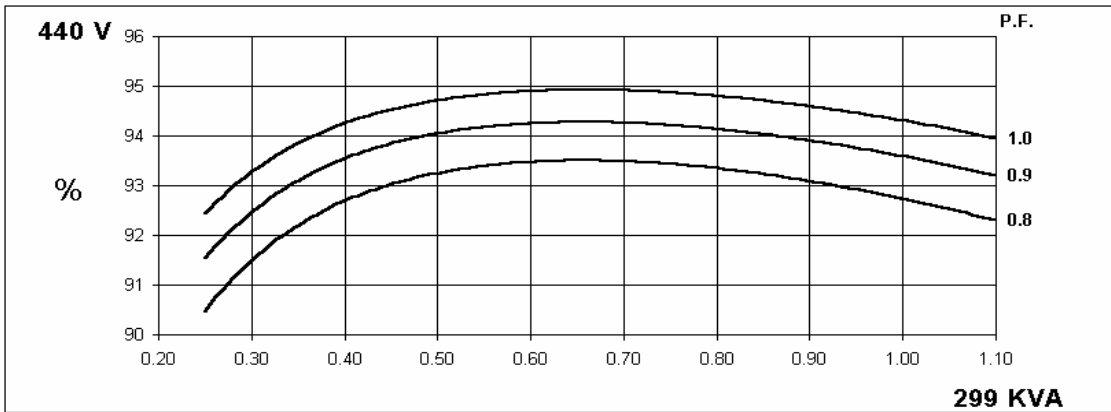
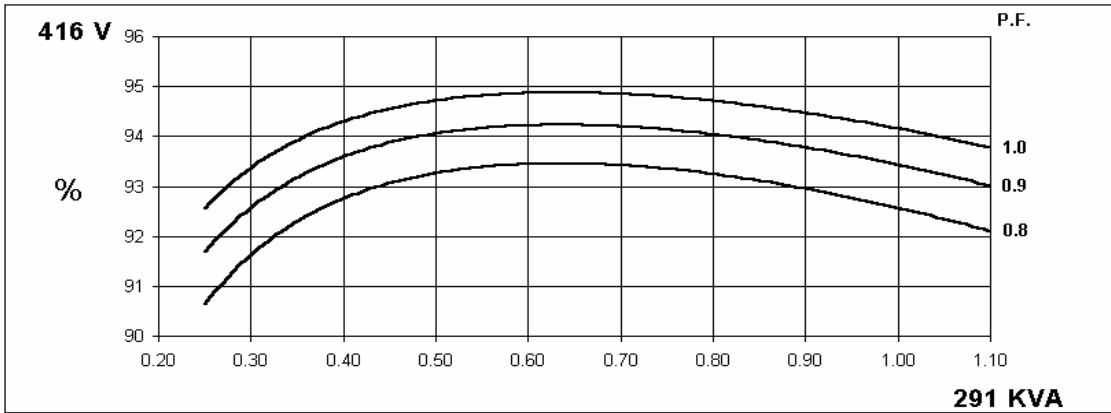

UCDI274K

Winding 311



Locked Rotor Motor Starting Curve

**50
Hz**

MX

SX

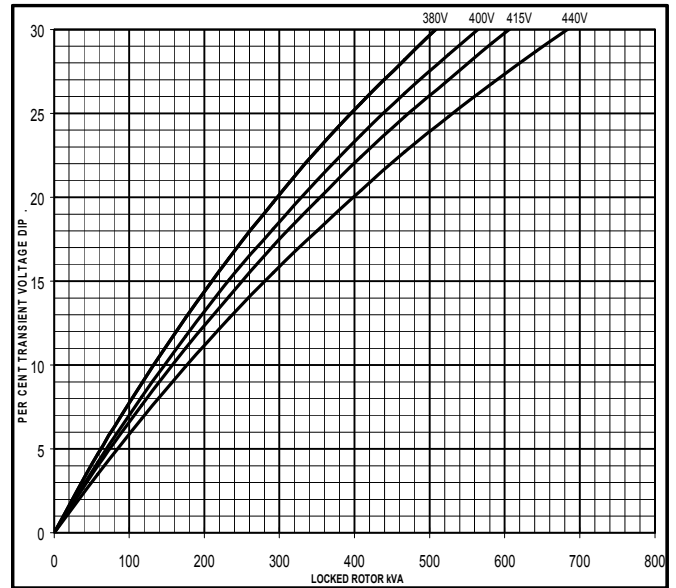
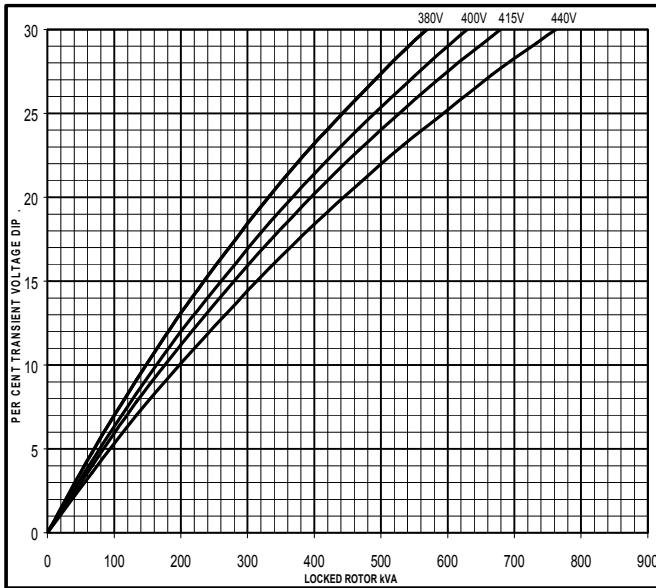

**60
Hz**

MX

SX

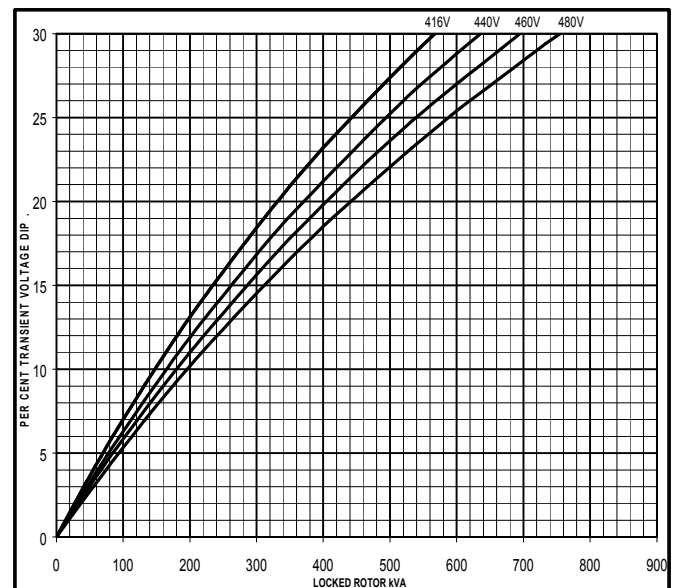
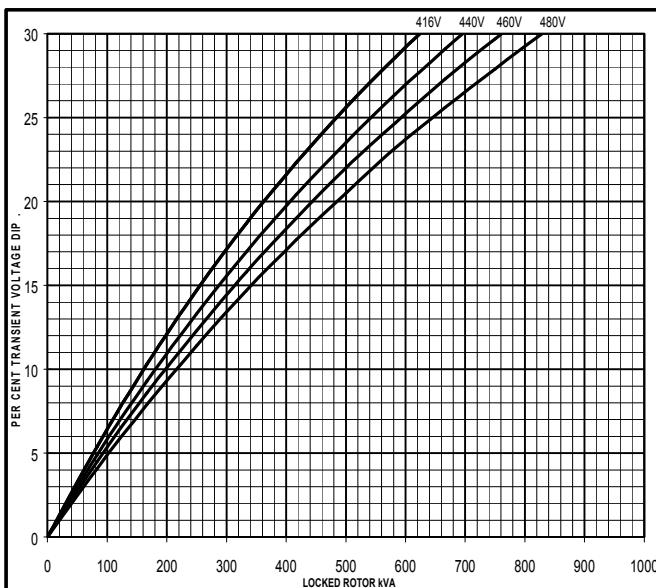

**Three-phase Short Circuit Decrement Curve. No-load Excitation at Rated Speed
Based on star (wye) connection.**

**50
Hz**

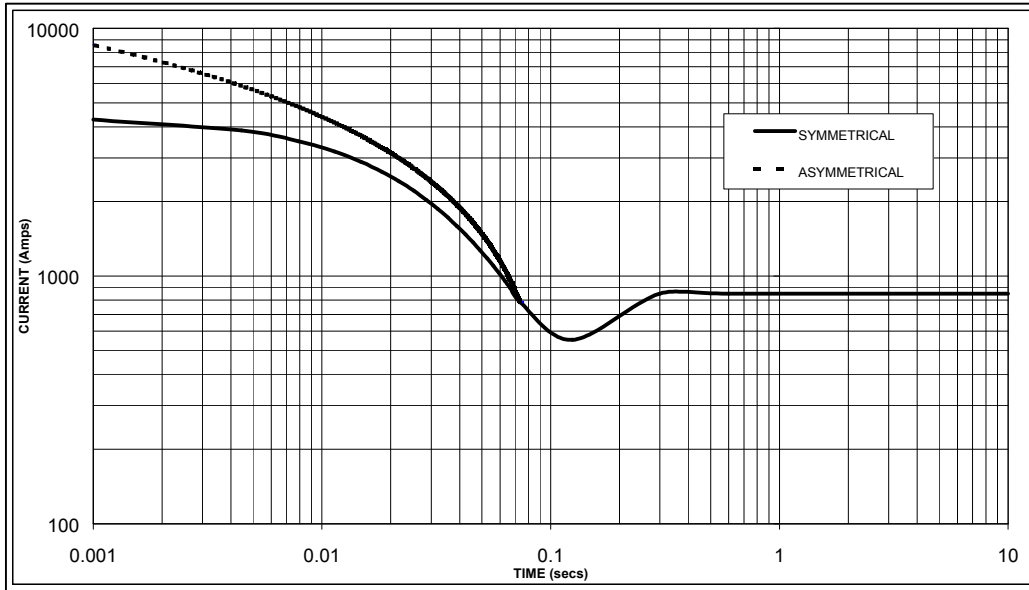

Sustained Short Circuit = 850 Amps

**60
Hz**

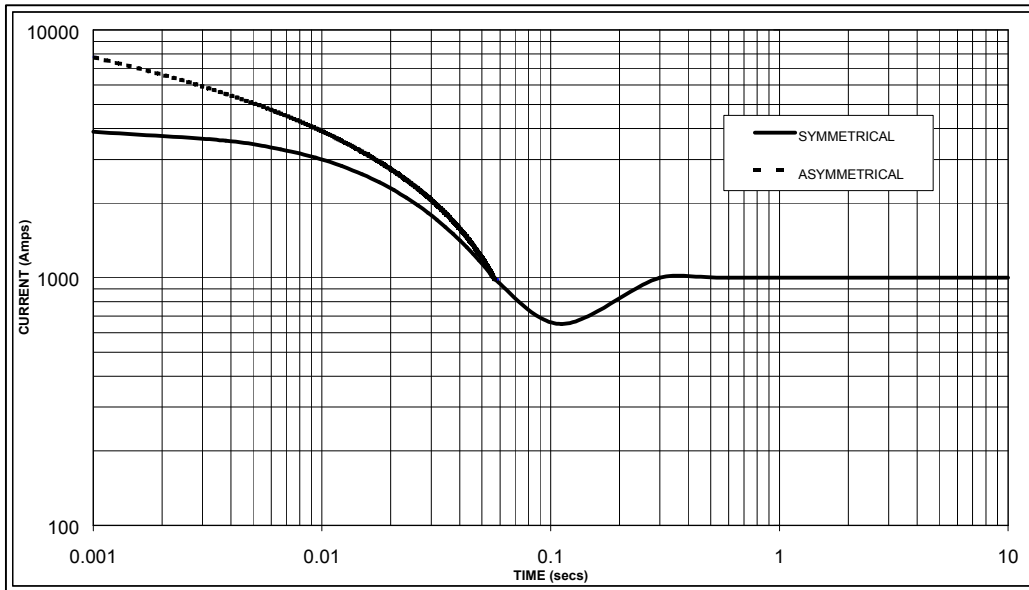

Sustained Short Circuit = 1,000 Amps

Note 1

The following multiplication factors should be used to adjust the values from curve between time 0.001 seconds and the minimum current point in respect of nominal operating voltage :

50Hz		60Hz	
Voltage	Factor	Voltage	Factor
380v	X 1.00	416v	X 1.00
400v	X 1.05	440v	X 1.07
415v	X 1.10	460v	X 1.12
440v	X 1.16	480v	X 1.16

The sustained current value is constant irrespective of voltage level

Note 2

The following multiplication factor should be used to convert the values calculated in accordance with NOTE 1 to those applicable to the various types of short circuit :

	3-phase	2-phase L-L	1-phase L-N
Instantaneous	x 1.00	x 0.87	x 1.30
Minimum	x 1.00	x 1.80	x 3.20
Sustained	x 1.00	x 1.50	x 2.50
Max. sustained duration	10 sec.	5 sec.	2 sec.

All other times are unchanged

Note 3

Curves are drawn for Star (Wye) connected machines. For other connection the following multipliers should be applied to current values as shown :

Parallel Star = Curve current value X 2

Series Delta = Curve current value X 1.732

UCDI274K

Winding 311 / 0.8 Power Factor



RATINGS

Class - Temp Rise	Cont. F - 105/40°C				Cont. H - 125/40°C				Standby - 150/40°C				Standby - 163/27°C				
50 Hz	Series Star (V)	380	400	415	440	380	400	415	440	380	400	415	440	380	400	415	440
	Parallel Star (V)	190	200	208	220	190	200	208	220	190	200	208	220	190	200	208	220
	Series Delta (V)	220	230	240	254	220	230	240	254	220	230	240	254	220	230	240	254
kVA	229.0	229.0	229.0	n/a	250.0	250.0	250.0	n/a	265.0	265.0	265.0	n/a	275.0	275.0	275.0	n/a	
kW	183.2	183.2	183.2	n/a	200.0	200.0	200.0	n/a	212.0	212.0	212.0	n/a	220.0	220.0	220.0	n/a	
Efficiency (%)	92.8	93.0	93.1	n/a	92.5	92.7	92.8	n/a	92.2	92.4	92.6	n/a	92.0	92.2	92.4	n/a	
kW Input	197.4	197.0	196.8	n/a	216.2	215.7	215.5	n/a	229.9	229.4	228.9	n/a	239.1	238.6	238.1	n/a	

60 Hz	Series Star (V)	416	440	460	480	416	440	460	480	416	440	460	480	416	440	460	480
	Parallel Star (V)	208	220	230	240	208	220	230	240	208	220	230	240	208	220	230	240
	Series Delta (V)	240	254	266	277	240	254	266	277	240	254	266	277	240	254	266	277
kVA	267.0	275.0	286.5	286.5	291.0	299.0	312.5	312.5	304.0	312.5	331.3	331.3	312.0	320.0	343.8	343.8	
kW	213.6	220.0	229.2	229.2	232.8	239.2	250.0	250.0	243.2	250.0	265.0	265.0	249.6	256.0	275.0	275.0	
Efficiency (%)	92.9	93.0	93.1	93.2	92.6	92.7	92.8	92.9	92.4	92.6	92.5	92.7	92.2	92.4	92.3	92.5	
kW Input	229.9	236.6	246.2	245.9	251.4	258.0	269.4	269.1	263.2	270.0	286.5	285.9	270.7	277.1	298.0	297.3	

DIMENSIONS

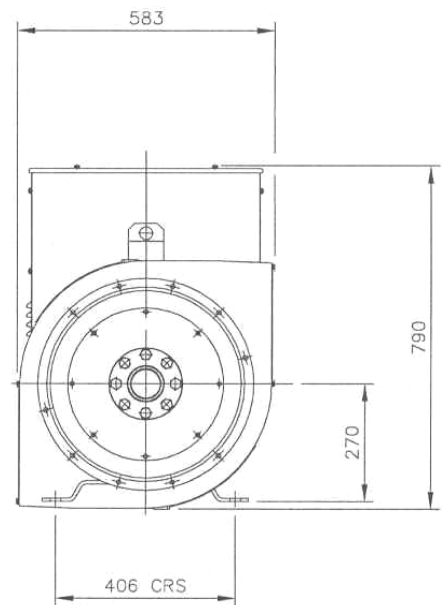
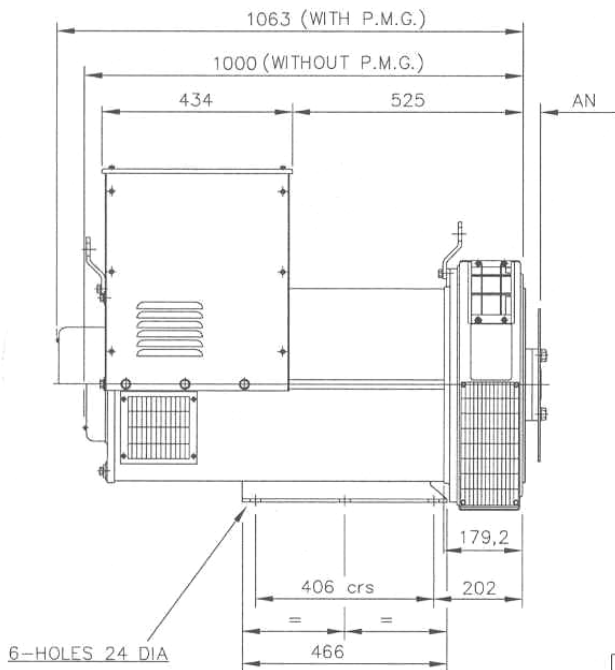

COUPLING DISC	AN
SAE 11,5	39,68
SAE 14	25,4



Barnack Road • Stamford • Lincolnshire • PE9 2NB
Tel: 00 44 (0)1780 484000 • Fax: 00 44 (0)1780 484100

QSK78-G9

Emissions Compliance:
EPA Tier 1 @ 50 Hz

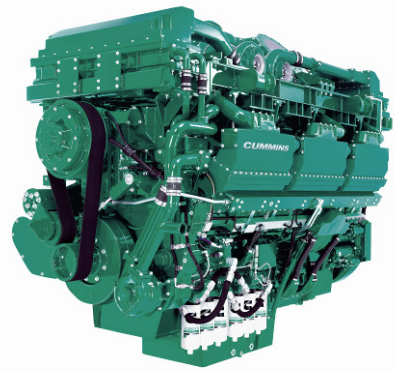

> Specification sheet



Our energy working for you.™

Description

The QSK78 is a V 18 cylinder engine with a 78 litre displacement. This Quantum series utilizes sophisticated electronics and premium engineering to provide outstanding performance levels, reliability and versatility for Standby, Prime and Continuous Power applications



This engine has been built to comply with CE certification.



This engine has been designed in facilities certified to ISO9001 and manufactured in facilities certified to ISO9001 or ISO9002.

Features

The new 4-turbo design architecture QSK78 uses the Cummins High Pressure Injection (HPI) PT full authority electronic fuel system. The HPI PT fuel system is managed by a G-Drive Governor Control System (GCS) controller, which is provided for off-engine mounting in the genset control panel. The Quantum Control has a specific fuel system board to interface with the HPI-PT fuel system and provides an Engine Protection package giving greater customer flexibility and cost effective alternatives in the control design and the benefits of Full Authority electronic control.

CTT (Cummins Turbo Technologies) HX82/HX83 turbo-charging utilizes exhaust energy with greater efficiency for improved emissions and fuel consumption.

Low Temperature After-cooling - Two-pump Two-loop (2P2L)

Ferrous Cast Ductile Iron (FCD) Pistons - High strength design delivers superior durability.

G-Drive Integrated Design - Each component has been specifically developed and rigorously tested for G-Drive products, ensuring high performance, durability and reliability.

Service and Support - G-Drive products are backed by an uncompromising level of technical support and after sales service, delivered through a world class service network.

1500 rpm (50 Hz Ratings)

Gross Engine Output			Net Engine Output			Typical Generator Set Output		
Standby	Prime	Base	Standby	Prime	Base	Standby (ESP)	Prime (PRP)	Base (COP)



kWm/BHP			kWm/BHP			kWe	kVA	kWe	kVA	kWe	kVA
2539/3404	2304/3088	2072/2777	2479/3324	2269/3043	2037/2732	2400	3000	2200	2750	1956	2444



General Engine Data

Type	4 cycle, Turbocharged, After-cooled
Bore mm	170
Stroke mm	190
Displacement Litre	77.6
Cylinder Block	Cast iron, 18 cylinder
Battery Charging Alternator	55A
Starting Voltage	24V
Fuel System	Direct injection Cummins HPI
Fuel Filter	Spin on fuel filters with water separator
Lube Oil Filter Type(s)	Spin on full flow filter
Lube Oil Capacity (l)	465
Flywheel Dimensions	SAE 00

Coolpac Performance Data

Cooling System Design	2 pump - 2 loop
Coolant Ratio	50% ethylene glycol; 50% water
Coolant Capacity (l)	Engine only – not applicable
Limiting Ambient Temp.**	
Fan Power	
Cooling System Air Flow (m ³ /s)**	
Air Cleaner Type	Dry replaceable element with restriction indicator

** @ 13 mm H₂O

Weight & Dimensions

Length	Width	Height	Weight (dry)
mm	mm	mm	kg
3062	1570	2031	9180

Fuel Consumption 1500 (50 Hz)

%	kWm	BHP	L/ph	US gal/ph
Standby Power				
100	2539	3404	569	150.3
Prime Power				
100	2304	3088	528	139.4
75	1728	2316	406	107.1
50	1152	1544	291	76.7
25	576	772	158	41.8
Continuous Power				
100	2072	2777	476	125.7

Cummins G-Drive Engines

Asia Pacific

10 Toh Guan Road
#07-01
TT International Tradepark
Singapore 608838
Phone 65 6417 2388
Fax 65 6417 2399

Europe, CIS, Middle

East and Africa
Manston Park Columbus Ave
Manston Ramsgate
Kent CT12 5BF. UK
Phone 44 1843 255000
Fax 44 1843 255902

Latin America

Rua Jati, 310, Cumbica
Guarulhos, SP 07180-900
Brazil
Phone 55 11 2186 4552
Fax 55 11 2186 4729

Mexico

Cummins S. de R.L. de C.V.
Eje 122 No. 200 Zona Industrial
San Luis Potosi, S.L.P. 78090
Mexico
Phone 52 444 870 6700
Fax 52 444 870 6811

North America

1400 73rd Avenue N.E.
Minneapolis, MN 55432
USA
Phone 1 763 574 5000
USA Toll-free 1 877 769 7669
Fax 1 763 574 5298

Ratings Definitions

Emergency Standby Power (ESP):

Applicable for supplying power to varying electrical load for the duration of power interruption of a reliable utility source. Emergency Standby Power (ESP) is in accordance with ISO 8528. Fuel Stop power in accordance with ISO 3046, AS 2789, DIN 6271 and BS 5514.

Limited-Time Running Power (LTP):

Applicable for supplying power to a constant electrical load for limited hours. Limited-Time Running Power (LTP) is in accordance with ISO 8528.

Prime Power (PRP):

Applicable for supplying power to varying electrical load for unlimited hours. Prime Power (PRP) is in accordance with ISO 8528. Ten percent overload capability is available in accordance with ISO 3046, AS 2789, DIN 6271 and BS 5514.

Base Load (Continuous) Power (COP):

Applicable for supplying power continuously to a constant electrical load for unlimited hours. Continuous Power (COP) in accordance with ISO 8528, ISO 3046, AS 2789, DIN6271 and BS 5514.



STAMFORD® | AvK®

LV 804 T WDG 13 - Technical Data Sheet

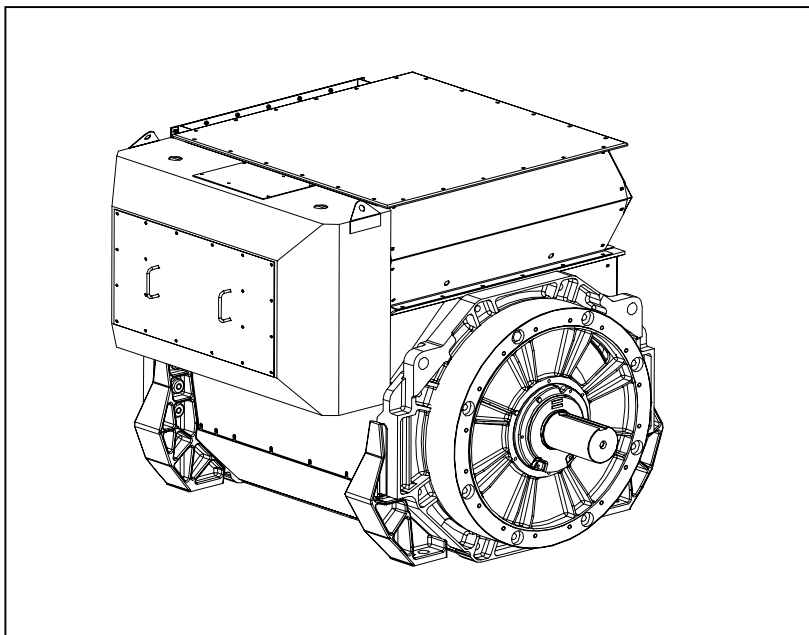

FRAME LV 804 T

SPECIFICATIONS & OPTIONS

STAMFORD | AvK

STANDARDS

Cummins Generator Technologies industrial generators meet the requirements of BS EN 60034 and the relevant sections of other national and international standards such as BS5000, VDE 0530, NEMA MG1-32, IEC60034, CSA C22.2-100, AS1359.

Other standards and certifications can be considered on request.

DESCRIPTION

The STAMFORD PI range of synchronous ac generators are brushless with a rotating field. They are separately excited by the STAMFORD Permanent Magnet Generator (PMG). This is a shaft mounted, high frequency, pilot exciter which provides a constant supply of clean power via the Automatic Voltage Regulator (AVR) to the main exciter. The main exciter output is fed to the main rotor, through a full wave bridge rectifier, protected by surge suppression.

VOLTAGE REGULATORS

The P range generators complete with a PMG are available with one AVR. The AVR has soft start voltage build up and built in protection against sustained over-excitation, which will de-excite the generator after a minimum of 8 seconds.

Underspeed protection (UFRO) is also provided on both AVRs. The UFRO will reduce the generator output voltage proportional to the speed of the generator below a pre-settable level.

The **MA330 AVR** is 3 phase rms sensed with a voltage regulation of 0.5% rms (see the note on regulation). The UFRO circuit has adjustable slope and dwell for controlled recovery from step loads. An over voltage protection circuit will shutdown the output device of the AVR, it can also trip an optional excitation circuit breaker if required. As an option, short circuit current limiting is available with the addition of current transformers.

The MA330 AVR needs a generator mounted current transformer to provide quadrature droop characteristics for load sharing during parallel operation.

Provision is also made for the connection of the STAMFORD power factor controller, for embedded applications, and a remote voltage trimmer.

WINDINGS & ELECTRICAL PERFORMANCE

All generator stators are wound to 2/3 pitch. This eliminates triplen (3rd, 9th, 15th ...) harmonics on the voltage waveform and is found to be the optimum design for trouble-free supply of non-linear loads. The 2/3 pitch design avoids excessive neutral currents sometimes seen with higher winding pitches. A fully connected damper winding reduces oscillations during paralleling. This winding, with the 2/3 pitch and carefully selected pole arc tooth designs, ensures very low levels of voltage waveform distortion.

TERMINALS & TERMINAL BOX

Standard generators feature a main stator with 6 ends brought out to the terminals, which are mounted on the frame at the non-drive end of the generator. A sheet steel terminal box contains the AVR and provides ample space for the customers' wiring and gland arrangements. It has removable panels for easy access.

SHAFT & KEYS

All generator rotors are dynamically balanced to better than BS6861:Part 1 Grade 2.5 for minimum vibration in operation. Two bearing generators are balanced with a half key.

INSULATION/IMPREGNATION

The insulation system is class 'H'.

All wound components are impregnated with materials and processes designed specifically to provide the high build required for static windings and the high mechanical strength required for rotating components.

QUALITY ASSURANCE

Generators are manufactured using production procedures having a quality assurance level to BS EN ISO 9001.

NOTE ON REGULATION

The stated voltage regulation may not be maintained in the presence of certain radio transmitted signals. Any change in performance will fall within the limits of Criteria 'B' of EN 61000-6-2:2001. At no time will the steady-state voltage regulation exceed 2%.

NB Continuous development of our products entitles us to change specification details without notice, therefore they must not be regarded as binding.

Front cover drawing is typical of the product range.

FRAME LV 804 T WINDING 13

RATINGS	REFER TO SALES AND SERVICE BRIEFING
MAXIMUM ALTITUDE	1000 METRES ABOVE SEA LEVEL
MAXIMUM AMBIENT TEMPERATURE	40° C
CONTROL SYSTEM SERIES 3	SEPARATELY EXCITED BY P.M.G.
A.V.R.	FULL WAVE RECTIFIED
VOLTAGE REGULATION	± 0.5% WITH 4% ENGINE GOVERNING
SUSTAINED SHORT CIRCUIT	REFER TO SHORT CIRCUIT DECREMENT CURVES OF THIS SECTION
INSULATION SYSTEM	CLASS H
PROTECTION	IP23 STANDARD
RATED POWER FACTOR	0.8
STATOR WINDING	DOUBLE LAYER LAP
WINDING PITCH	2/3
WINDING LEADS	6
R.F.I. SUPPRESSION	BS EN 50081/2-1/2 VDE 0875G VDE 0875N For other standards apply to the factory
WAVEFORM DISTORTION	NO LOAD < 1.5% NON-DISTORTING BALANCED LINEAR LOAD < 3.0%
MAXIMUM OVERSPEED	2250 Rev/Min
BEARING DRIVE END	ISO 6232 C3
BEARING NON DRIVE END	ISO 6324 C3
EFFICIENCY	REFER TO EFFICIENCY CURVES OF THIS SECTION
FREQUENCY	60Hz
TELEPHONE INTERFERENCE	TIF < 50
COOLING AIR	3.7 m ³ /sec
VOLTAGE STAR (Y)	380
KVA BASE RATING FOR REACTANCE VALUES	3400
X _d DIRECT AXIS SYNCHRONOUS	2.900
X' _d DIRECT AXIS TRANSIENT	0.214
X'' _d DIRECT AXIS SUB-TRANSIENT	0.158
X _q QUADRATURE AXIS REACTANCE	1.950
X'' _q QUAD. AXIS SUB-TRANSIENT	0.293
X _L LEAKAGE REACTANCE	0.094
X ₂ NEGATIVE PHASE SEQUENCE	0.226
X ₀ ZERO PHASE SEQUENCE	0.029
REACTANCES ARE SATURATED	VALUES ARE PER UNIT AT RATING AND VOLTAGE INDICATED
T _d TRANSIENT TIME CONSTANT	0.190
T'' _d SUB-TRANSIENT TIME CONSTANT	0.015
T' _{do} O.C. FIELD TIME CONSTANT	4.300
T _a ARMATURE TIME CONSTANT	0.075
SHORT CIRCUIT RATIO	1/X _d
STATOR WINDING RESISTANCE (L-N)	0.000314
ROTOR WINDING RESISTANCE	1.500
EXCITER STATOR FIELD RESISTANCE	17.50
EXCITER ROTOR RESISTANCE (L-L)	0.076
PMG STATOR RESISTANCE (L-L)	3.800
	RESISTANCE VALUES ARE IN OHMS AT 20° C
NO LOAD EXCITATION VOLTAGE	15.0
FULL LOAD EXCITATION VOLTAGE	63.0

Continuous development of our products entitles us to change specification details without notice, therefore they must not be regarded as binding.

THREE PHASE EFFICIENCY CURVES

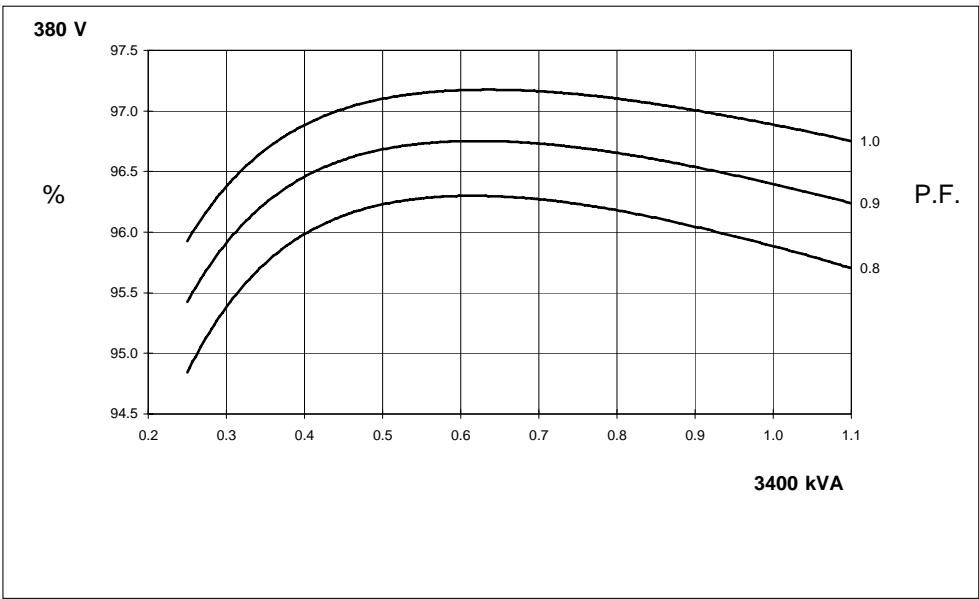

FULL WAVE RECTIFIED AVR
 LOCKED ROTOR MOTOR STARTING CURVE

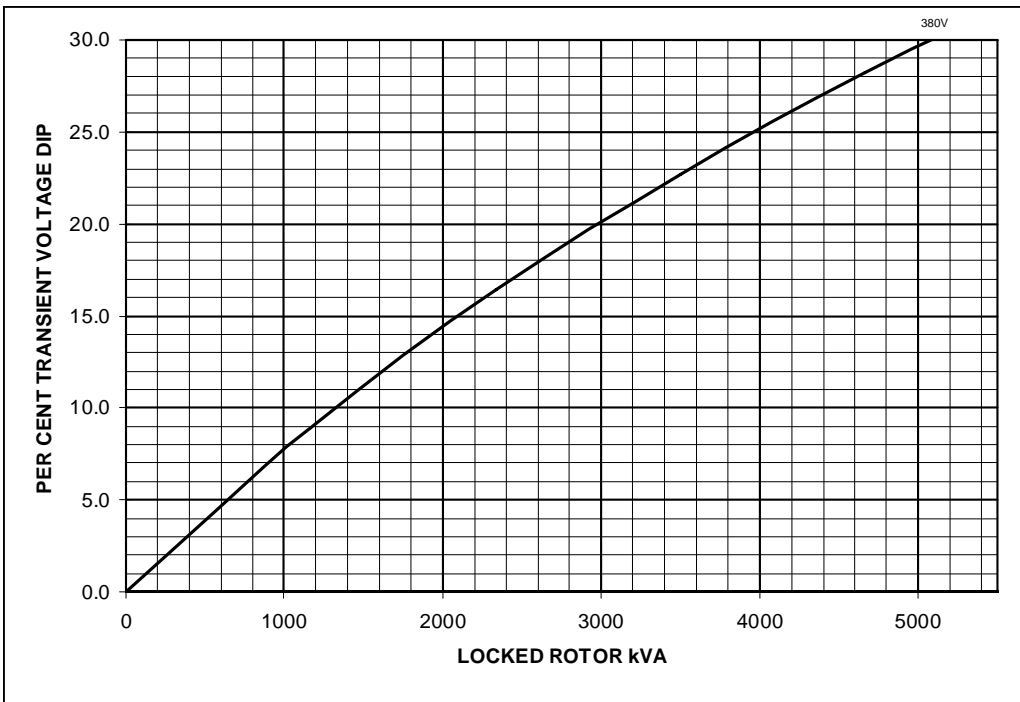

FRAME LV 804 T WDG 13 60Hz

Three Phase Short Circuit Decrement Curve
 No- Load Excitation at Rated Speed

Based on series star (wye) connection

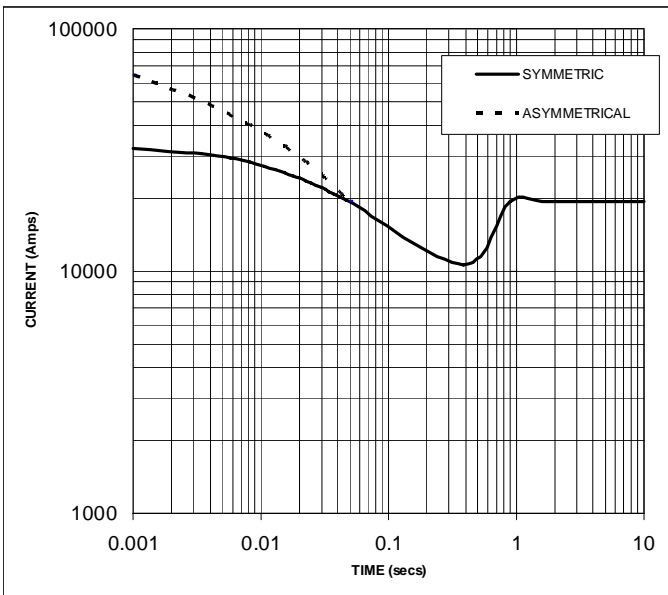

NOTE 1

THE FOLLOWING MULTIPLICATION FACTORS SHOULD BE USED TO ADJUST THE VALUES FROM CURVES BETWEEN THE 0.001 SECONDS AND THE MINIMUM CURRENT POINT IN RESPECT OF NOMINAL OPERATING VOLTAGE

VOLTAGE	FACTOR
380V	X 1.00

THE SUSTAINED CURRENT VALUE IS CONSTANT IRRESPECTIVE OF VOLTAGE LEVEL

NOTE 2

THE FOLLOWING MULTIPLICATION FACTORS SHOULD BE USED TO CONVERT THE VALUES CALCULATED IN ACCORDANCE WITH NOTE 1 TO THOSE APPLICABLE TO THE VARIOUS TYPES OF SHORT CIRCUIT

	3 PHASE	2 PHASE L-L	1 PHASE L-N
INSTANTANEOUS	X 1.0	X 0.87	X 1.30
MINIMUM	X 1.0	X 1.80	X 3.20
SUSTAINED	X 1.0	X 1.50	X 2.50
MAX SUSTAINED DURATION	10 SEC	5 SEC	2 SEC

ALL OTHER TIMES ARE UNCHANGED

SUSTAINED SHORT CIRCUIT = 19372 Amps

FRAME LV 804 T
WINDING 13 0.8 Power Factor



RATINGS

Class - Temp Rise		Cont. F - 105/40°C	Cont. H - 125/40°C	Standby - 150/40°C	Standby - 163/27°C
50Hz	Star (V)	N/A	N/A	N/A	N/A
	kVA	N/A	N/A	N/A	N/A
	kW	N/A	N/A	N/A	N/A
	Efficiency (%)	N/A	N/A	N/A	N/A
	kW Input	N/A	N/A	N/A	N/A
60Hz	Star (V)	380	380	380	380
	kVA	3130	3400	3630	3740
	kW	2504	2720	2904	2992
	Efficiency (%)	96.0	95.9	95.8	95.7
	kW Input	2609	2837	3033	3126

TYPICAL DIMENSIONS - Further arrangements available - please refer to factory

P80 R/S/T CORES

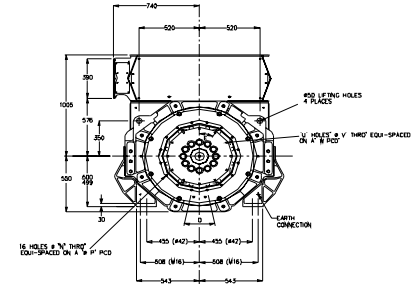
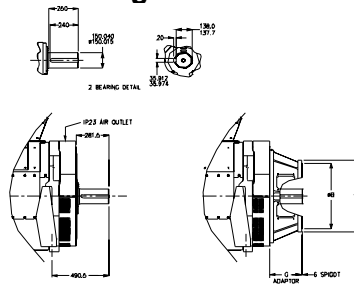
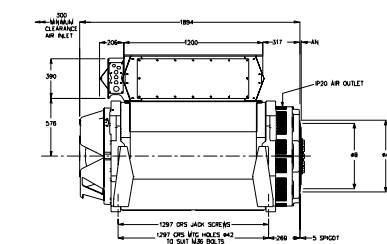

P80 R/S/T CORES 1-BRG ADAPTORS					
SAE	A	B	N	P	D
SAE 0	711	647.7	14	679.5	22.5"
SAE 00	883	787.4	14	851.0	22.5"

P80 R/S/T/W/X CORES 1-BRG COUPLING DISC						
SAE	AN	C	U	Y	W	E
1B	15.9	571.4	12	16.7	543.0	30"
21	0	673.0	12	16.7	641.3	30"
24	0	733.3	12	20.7	692.0	30"

P80 R/S/T/W/X CORES 2-BRG ADAPTORS		
	SAE	G
P80 R/S/T	0	271.5
P80 R/S/T	00	271.5
P80 W/X	0	271.5
P80 W/X	00	329.0

P80 R/S/T/W/X CORES 2-BRG ADAPTORS					
SAE	A	B	N	P	D
SAE 0	711	647.7	14	679.5	22.5"
SAE 00	883	787.4	14	851.0	22.5"

P80 W/X CORES

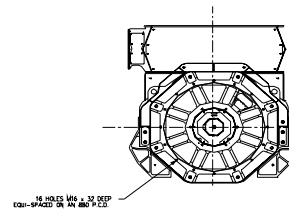
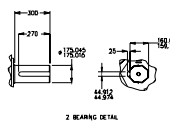
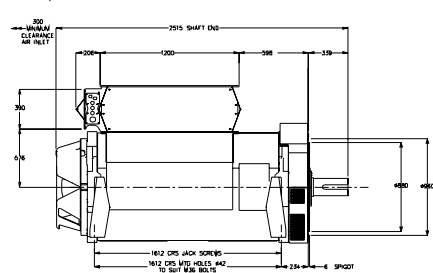

Barnack Road • Stamford • Lincolnshire • PE9 2NB
Tel: 00 44 (0)1780 484000 • Fax: 00 44 (0)1780 484100

QSK60-G13

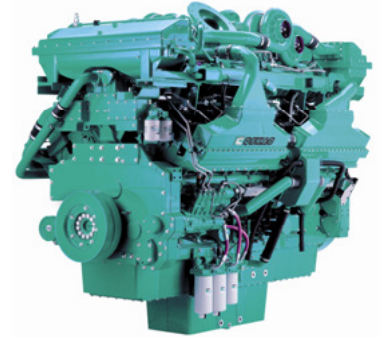

> Specification sheet



Our energy working for you.™

Description

The QSK60 is a V 16 cylinder engine with a 60 litre displacement. This Quantum series utilizes sophisticated electronics and premium engineering to provide outstanding performance levels, reliability and versatility for Standby, Prime and Continuous Power applications.



This engine has been built to comply with CE certification.



This engine has been designed in facilities certified to ISO9001 and manufactured in facilities certified to ISO9001 or ISO9002.

Features

High pressure fuel pump, Modular Common Rail fuel System (MCRS) and state of the art integrated electronic control system provide superior performance, efficiency and diagnostics. The electronic fuel pumps deliver up to 1600 bar injection pressure and eliminate mechanical linkage adjustments. The new MCRS utilizes an electric priming pump which is integrated with the off-engine stage-1 fuel filter head and is controlled and powered by the engine ECM. The stage-2 fuel filters are mounted on-engine

CTT (Cummins Turbo Technologies) HX82/HX83 turbo-charging utilizes exhaust energy with greater efficiency for improved emissions and fuel consumption.

Low Temperature After-cooling - Two-pump Two-loop (2P2L)

Ferrous Cast Ductile Iron (FCD) Pistons - High strength design delivers superior durability.

G-Drive Integrated Design - Each component has been specifically developed and rigorously tested for G-Drive products, ensuring high performance, durability and reliability.

Service and Support - G-Drive products are backed by an uncompromising level of technical support and after sales service, delivered through a world class service network.

1500 rpm (50 Hz Ratings)

Gross Engine Output			Net Engine Output			Typical Generator Set Output					
Standby	Prime	Base	Standby	Prime	Base	Standby (ESP)		Prime (PRP)		Base (COP)	
kWm/BHP			kWm/BHP			kWe	kVA	kWe	kVA	kWe	kVA
2164/2901	1727/2315	N/A	2108/2826	1692/2269	N/A	2000	2500	1600	2000	N/A	N/A



General Engine Data

Type	4 cycle, Turbocharged, After-cooled
Bore mm	159
Stroke mm	190
Displacement Litre	60.2
Cylinder Block	Cast iron, 16 cylinder
Battery Charging Alternator	55A
Starting Voltage	24V
Fuel System	Direct injection Cummins MCERS
Fuel Filter	Spin on fuel filters with water separator
Lube Oil Filter Type(s)	Spin on full flow filter
Lube Oil Capacity (l)	280
Flywheel Dimensions	SAE 0

Coolpac Performance Data

Cooling System Design	2 pump – 2 loop
Coolant Ratio	50% ethylene glycol; 50% water
Coolant Capacity (l)	Engine only – not applicable
Limiting Ambient Temp.**	
Fan Power	
Cooling System Air Flow (m ³ /s)**	
Air Cleaner Type	Dry replaceable element with restriction indicator

** @ 13 mm H₂O

Ratings Definitions

Emergency Standby Power (ESP):

Applicable for supplying power to varying electrical load for the duration of power interruption of a reliable utility source. Emergency Standby Power (ESP) is in accordance with ISO 8528. Fuel Stop power in accordance with ISO 3046, AS 2789, DIN 6271 and BS 5514.

Limited-Time Running Power (LTP):

Applicable for supplying power to a constant electrical load for limited hours. Limited-Time Running Power (LTP) is in accordance with ISO 8528.

Prime Power (PRP):

Applicable for supplying power to varying electrical load for unlimited hours. Prime Power (PRP) is in accordance with ISO 8528. Ten percent overload capability is available in accordance with ISO 3046, AS 2789, DIN 6271 and BS 5514.

Base Load (Continuous) Power (COP):

Applicable for supplying power continuously to a constant electrical load for unlimited hours. Continuous Power (COP) in accordance with ISO 8528, ISO 3046, AS 2789, DIN6271 and BS 5514.

Weight & Dimensions

Length	Width	Height	Weight (dry)
mm	mm	mm	kg
2781	1794	2155	7185

Fuel Consumption 1500 (50 Hz)

%	kWm	BHP	L/ph	US gal/ph
Standby Power				
100	2164	2901	523	138.1
Prime Power				
100	1727	2315	399	105.4
75	1295	1736	302	79.7
50	863	1158	210	55.5
25	432	579	119	31.4
Continuous Power				
100	N/A	N/A	N/A	N/A

Cummins G-Drive Engines

Asia Pacific

10 Toh Guan Road
#07-01
TT International Tradepark
Singapore 608838
Phone 65 6417 2388
Fax 65 6417 2399

Europe, CIS, Middle

East and Africa
Manston Park Columbus Ave
Manston Ramsgate
Kent CT12 5BF. UK
Phone 44 1843 255000
Fax 44 1843 255902

Latin America

Rua Jati, 310, Cumbica
Guarulhos, SP 07180-900
Brazil
Phone 55 11 2186 4552
Fax 55 11 2186 4729

Mexico

Cummins S. de R.L. de C.V.
Eje 122 No. 200 Zona Industrial
San Luis Potosí, S.L.P. 78090
Mexico
Phone 52 444 870 6700
Fax 52 444 870 6811

North America

1400 73rd Avenue N.E.
Minneapolis, MN 55432
USA
Phone 1 763 574 5000
USA Toll-free 1 877 769 7669
Fax 1 763 574 5298



STAMFORD[®]

PI734F - Technical Data Sheet

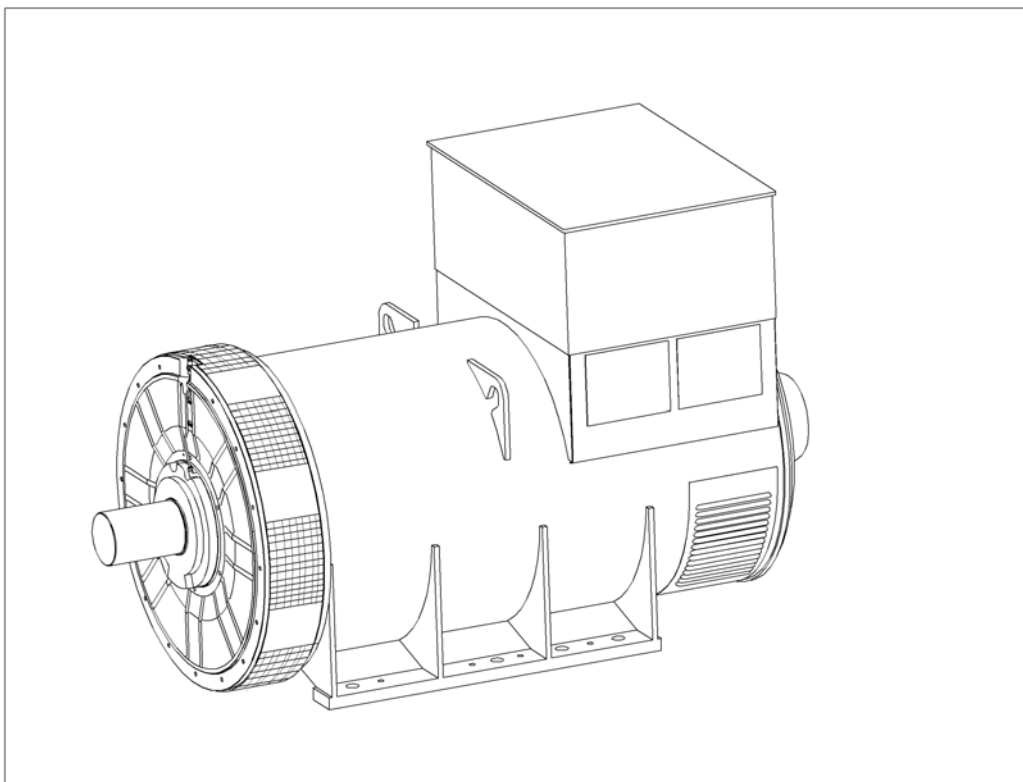

PI734F

SPECIFICATIONS & OPTIONS

STANDARDS

Newage Stamford industrial generators meet the requirements of BS EN 60034 and the relevant sections of other national and international standards such as BS5000, VDE 0530, NEMA MG1-32, IEC60034, CSA C22.2-100, AS1359.

Other standards and certifications can be considered on request.

DESCRIPTION

The STAMFORD PI range of synchronous ac generators are brushless with a rotating field. They are separately excited by the STAMFORD Permanent Magnet Generator (PMG). This is a shaft mounted, high frequency, pilot exciter which provides a constant supply of clean power via the Automatic Voltage Regulator (AVR) to the main exciter. The main exciter output is fed to the main rotor, through a full wave bridge rectifier, protected by surge suppression.

VOLTAGE REGULATORS

The PI range generators, complete with a PMG, are available with one of two AVRs. Each AVR has soft start voltage build up and built in protection against sustained over-excitation, which will de-excite the generator after a minimum of 8 seconds.

Underspeed protection (UFRO) is also provided on both AVRs. The UFRO will reduce the generator output voltage proportional to the speed of the generator below a pre-settable level.

The **MX341 AVR** is two phase sensed with a voltage regulation of $\pm 1\%$. (see the note on regulation).

The **MX321 AVR** is 3 phase rms sensed with a voltage regulation of 0.5% rms (see the note on regulation). The UFRO circuit has adjustable slope and dwell for controlled recovery from step loads. An over voltage protection circuit will shutdown the output device of the AVR, it can also trip an optional excitation circuit breaker if required. As an option, short circuit current limiting is available with the addition of current transformers.

Both the MX341 and the MX321 need a generator mounted current transformer to provide quadrature droop characteristics for load sharing during parallel operation. Provision is also made for the connection of the STAMFORD power factor controller, for embedded applications, and a remote voltage trimmer.

WINDINGS & ELECTRICAL PERFORMANCE

All generator stators are wound to 2/3 pitch. This eliminates triplen (3rd, 9th, 15th ...) harmonics on the voltage waveform and is found to be the optimum design for trouble-free supply of non-linear loads. The 2/3 pitch design avoids excessive neutral currents sometimes seen with higher winding pitches. A fully connected damper winding reduces oscillations during paralleling. This winding, with the 2/3 pitch and carefully selected pole and tooth designs, ensures very low levels of voltage waveform distortion.

TERMINALS & TERMINAL BOX

Standard generators feature a main stator with 6 ends brought out to the terminals, which are mounted on the frame at the non-drive end of the generator. A sheet steel terminal box contains the AVR and provides ample space for the customers' wiring and gland arrangements. It has removable panels for easy access.

SHAFT & KEYS

All generator rotors are dynamically balanced to better than BS6861:Part 1 Grade 2.5 for minimum vibration in operation. Two bearing generators are balanced with a half key.

INSULATION/IMPREGNATION

The insulation system is class 'H', and meets the requirements of UL1446.

All wound components are impregnated with materials and processes designed specifically to provide the high build required for static windings and the high mechanical strength required for rotating components.

QUALITY ASSURANCE

Generators are manufactured using production procedures having a quality assurance level to BS EN ISO 9001.

NOTE ON REGULATION

The stated voltage regulation may not be maintained in the presence of certain radio transmitted signals. Any change in performance will fall within the limits of Criteria 'B' of EN 61000-6-2:2001. At no time will the steady-state voltage regulation exceed 2%.

Note: Continuous development of our products entitles us to change specification details without notice, therefore they must not be regarded as binding.

Front cover drawing is typical of the product range.

PI734F

WINDING 312

STAMFORD

CONTROL SYSTEM	SEPARATELY EXCITED BY P.M.G.		
A.V.R.	MX341	MX321	
VOLTAGE REGULATION	± 1%	± 0.5 %	With 4% ENGINE GOVERNING
SUSTAINED SHORT CIRCUIT	REFER TO SHORT CIRCUIT DECREMENT CURVES (page 7)		

INSULATION SYSTEM	CLASS H
PROTECTION	IP23
RATED POWER FACTOR	0.8
STATOR WINDING	DOUBLE LAYER LAP
WINDING PITCH	TWO THIRDS
WINDING LEADS	6
MAIN STATOR RESISTANCE	0.00076 Ohms PER PHASE AT 22°C STAR CONNECTED
MAIN ROTOR RESISTANCE	2.31 Ohms at 22°C
EXCITER STATOR RESISTANCE	17.5 Ohms at 22°C
EXCITER ROTOR RESISTANCE	0.063 Ohms PER PHASE AT 22°C
R.F.I. SUPPRESSION	BS EN 61000-6-2 & BS EN 61000-6-4, VDE 0875G, VDE 0875N. refer to factory for others
WAVEFORM DISTORTION	NO LOAD < 1.5% NON-DISTORTING BALANCED LINEAR LOAD < 5.0%
MAXIMUM OVERSPEED	2250 Rev/Min
BEARING DRIVE END	BALL. 6232 C3
BEARING NON-DRIVE END	BALL. 6319 C3

	1 BEARING	2 BEARING
WEIGHT COMP. GENERATOR	3840 kg	3807 kg
WEIGHT WOUND STATOR	1908 kg	1908 kg
WEIGHT WOUND ROTOR	1609 kg	1565 kg
WR ² INERTIA	49.3409 kgm ²	48.424 kgm ²
SHIPPING WEIGHTS in a crate	3913kg	3876kg
PACKING CRATE SIZE	216 x 105 x 154(cm)	216 x 105 x 154(cm)

	50 Hz				60 Hz			
TELEPHONE INTERFERENCE	THF<2%				TIF<50			
COOLING AIR	2.69 m ³ /sec 5700 cfm				3.45 m ³ /sec 7300 cfm			
VOLTAGE STAR	380/220	400/231	415/240	440/254	416/240	440/254	460/266	480/277
kVA BASE RATING FOR REACTANCE VALUES	2020	2080	2080	2040	2340	2500	2550	2600
X _d DIR. AXIS SYNCHRONOUS	2.93	2.73	2.53	2.21	3.54	3.38	3.16	2.96
X' _d DIR. AXIS TRANSIENT	0.18	0.17	0.15	0.13	0.21	0.20	0.19	0.18
X'' _d DIR. AXIS SUBTRANSIENT	0.13	0.12	0.11	0.10	0.16	0.15	0.14	0.13
X _q QUAD. AXIS REACTANCE	1.89	1.75	1.63	1.42	2.28	2.18	2.03	1.90
X'' _q QUAD. AXIS SUBTRANSIENT	0.26	0.25	0.23	0.20	0.32	0.31	0.29	0.27
X _L LEAKAGE REACTANCE	0.03	0.03	0.03	0.03	0.04	0.04	0.04	0.03
X ₂ NEGATIVE SEQUENCE	0.19	0.17	0.16	0.14	0.23	0.22	0.20	0.19
X ₀ ZERO SEQUENCE	0.02	0.02	0.02	0.02	0.03	0.03	0.02	0.02

REACTANCES ARE SATURATED

VALUES ARE PER UNIT AT RATING AND VOLTAGE INDICATED

T' _d TRANSIENT TIME CONST.	0.154s
T'' _d SUB-TRANSTIME CONST.	0.02s
T' _{do} O.C. FIELD TIME CONST.	2.54s
T _a ARMATURE TIME CONST.	0.02s
SHORT CIRCUIT RATIO	1/X _d

50
Hz

PI734F
Winding 312

STAMFORD

THREE PHASE EFFICIENCY CURVES

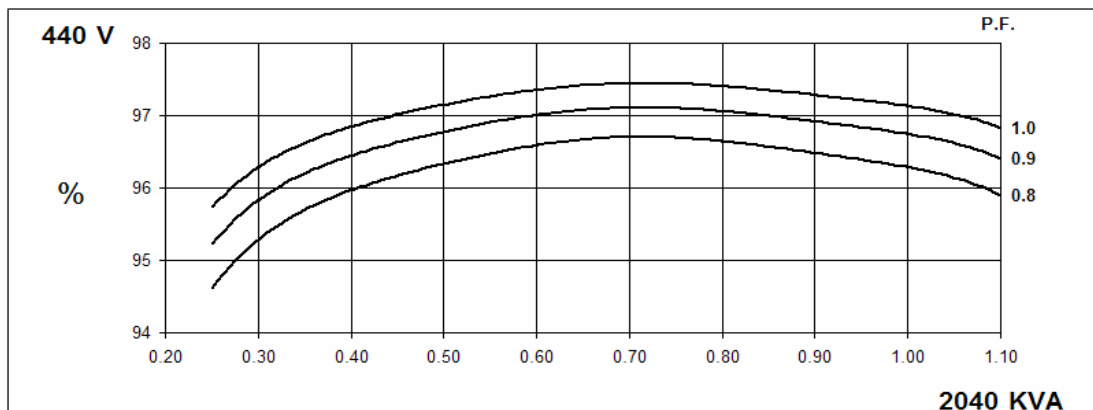
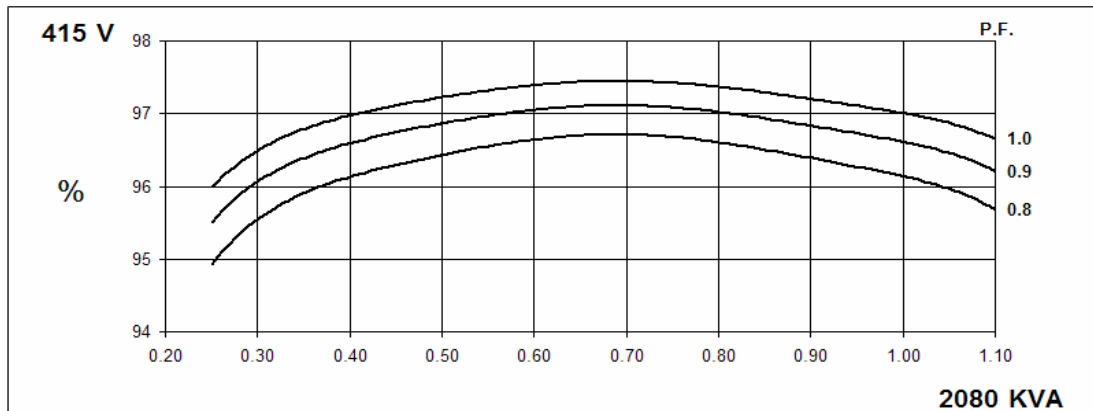
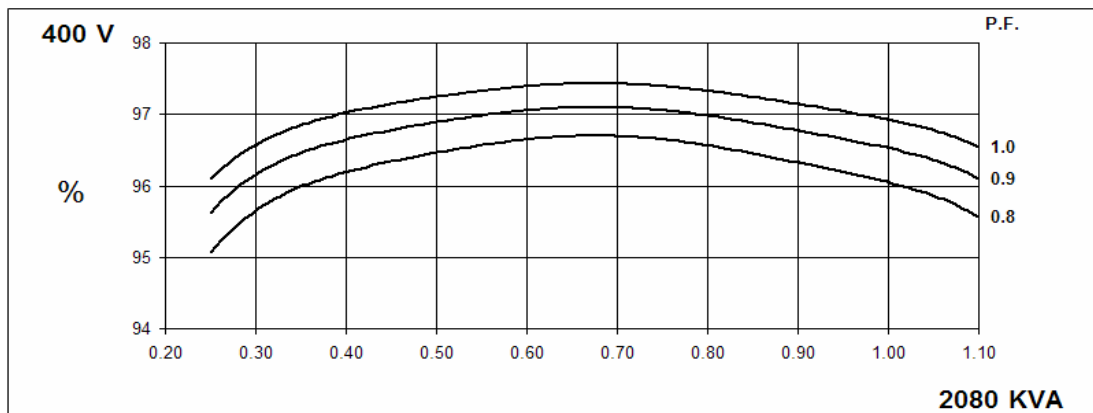
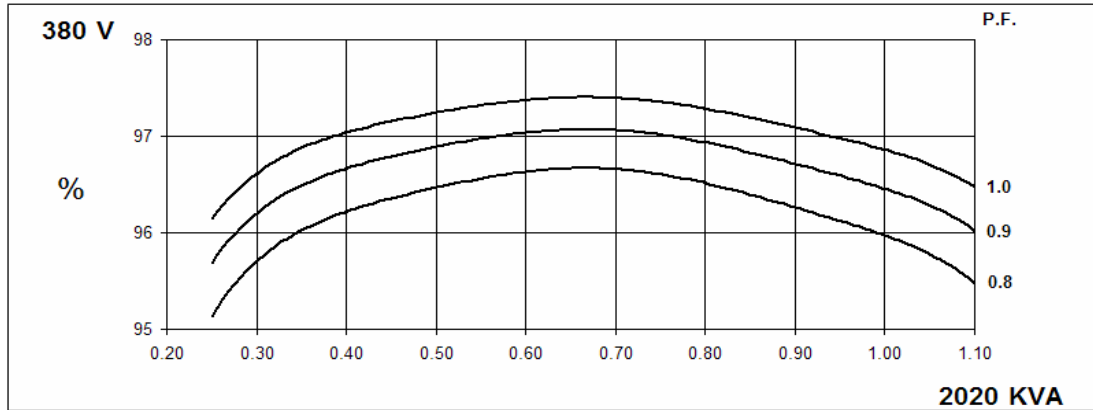

60
Hz

PI734F
Winding 312

STAMFORD

THREE PHASE EFFICIENCY CURVES

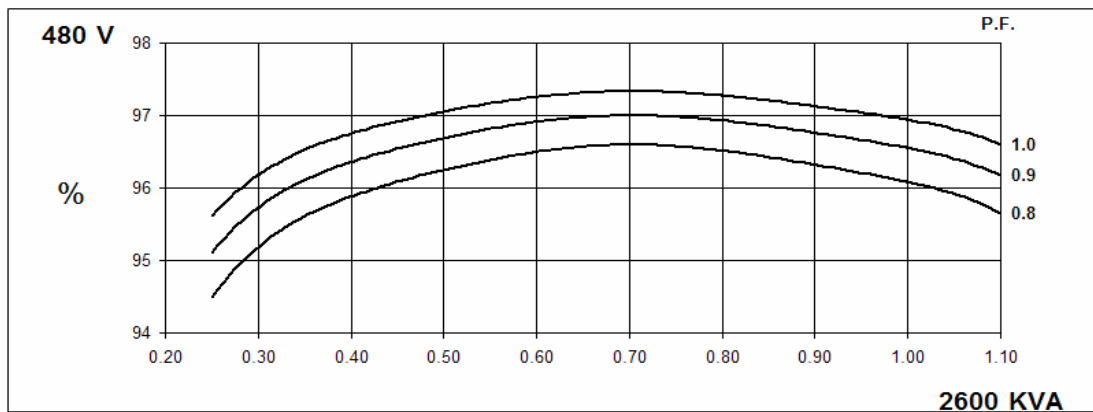
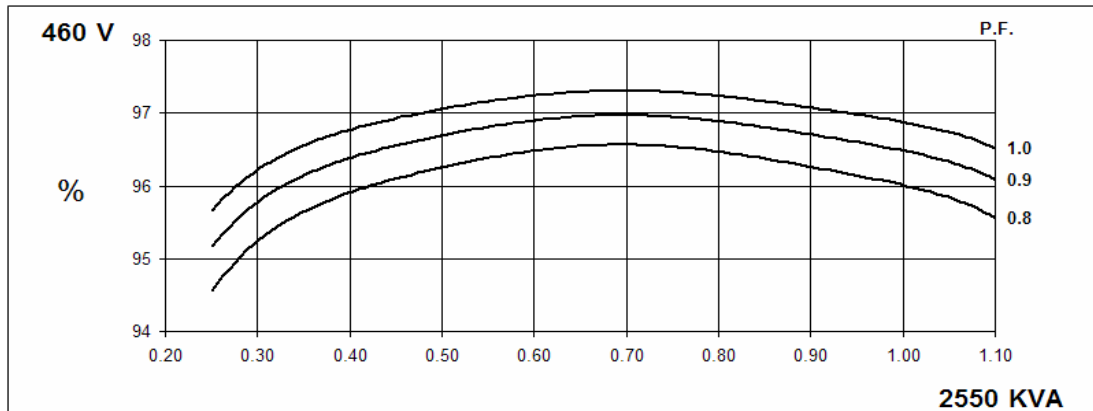
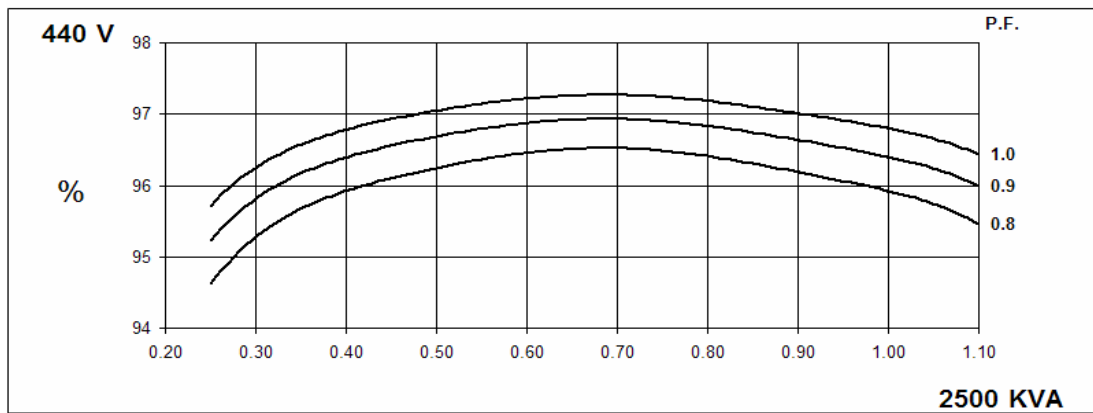
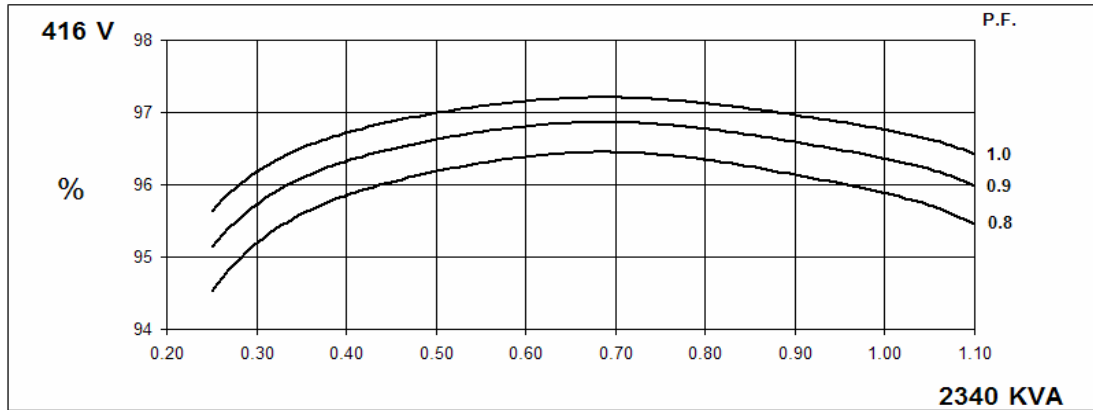

PI734F
Winding 312

STAMFORD

Locked Rotor Motor Starting Curve

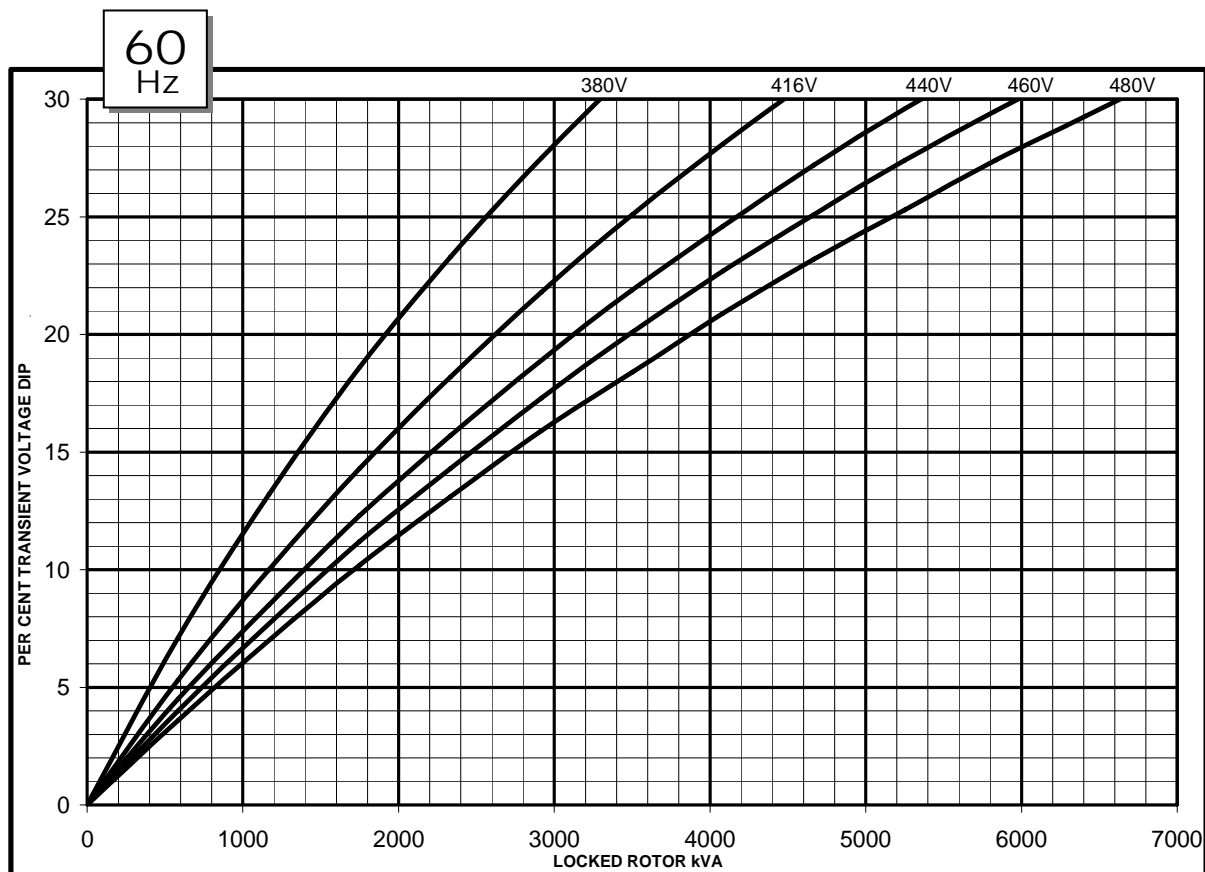
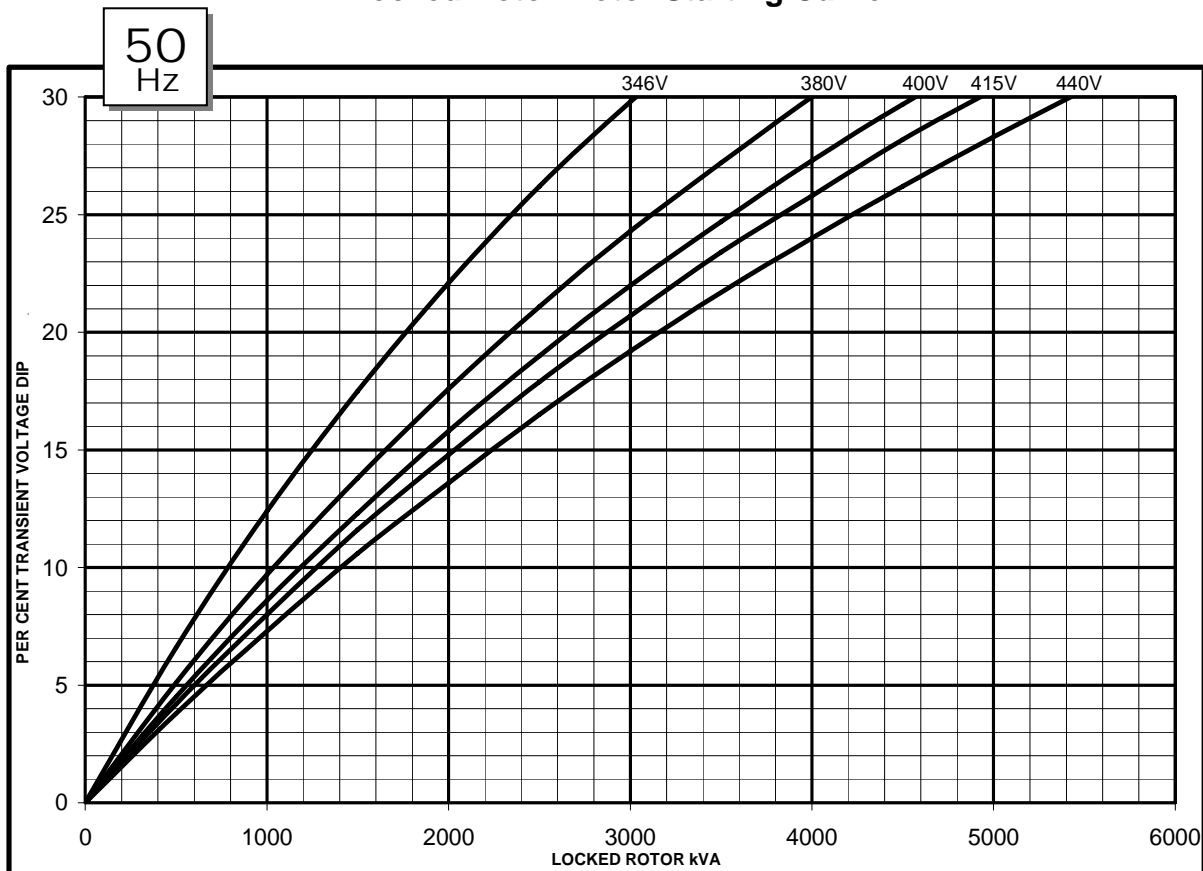

**Three-phase Short Circuit Decrement Curve. No-load Excitation at Rated Speed
Based on star (wye) connection.**

50
Hz

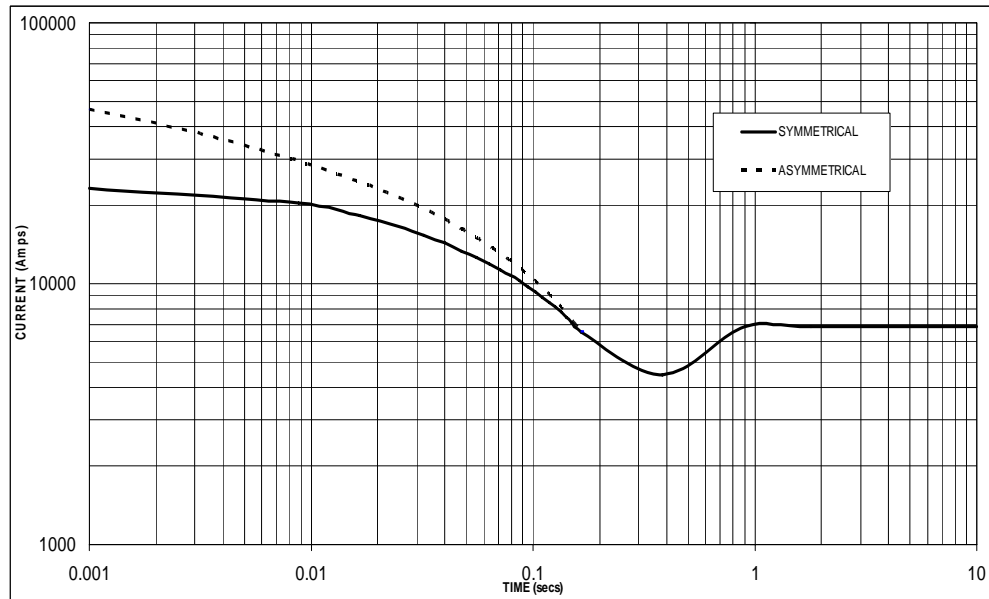

Sustained Short Circuit = 6,850 Amps

60
Hz

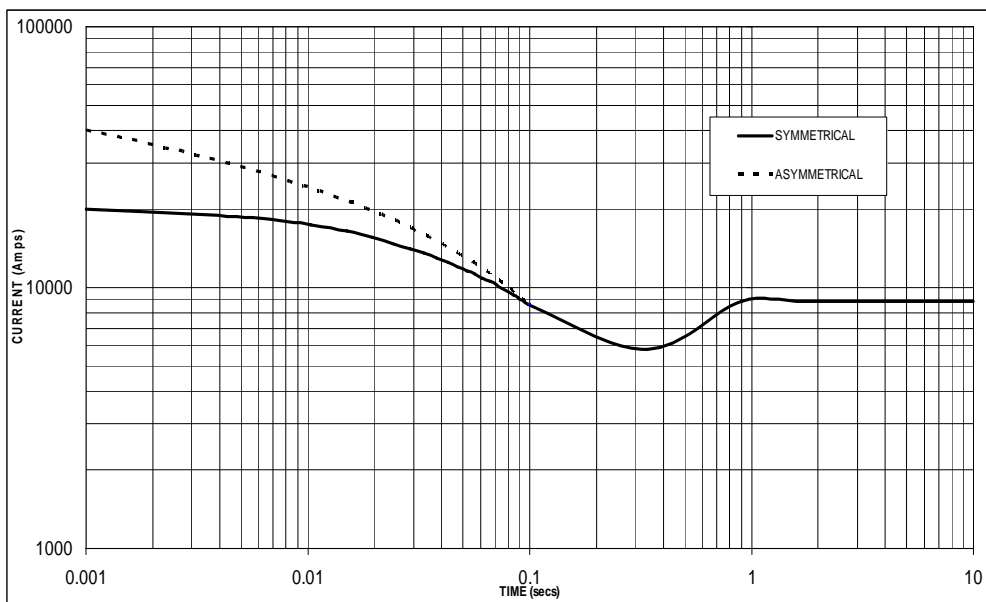

Sustained Short Circuit = 8,900 Amps

Note 1

The following multiplication factors should be used to adjust the values from curve between time 0.001 seconds and the minimum current point in respect of nominal operating voltage :

50Hz		60Hz	
Voltage	Factor	Voltage	Factor
380v	x 1.00	416v	x 1.00
400v	x 1.05	440v	x 1.06
415v	x 1.09	460v	x 1.10
440v	x 1.16	480v	x 1.15

The sustained current value is constant irrespective of voltage level

Note 2

The following multiplication factor should be used to convert the values calculated in accordance with NOTE 1 to those applicable to the various types of short circuit :

	3-phase	2-phase L-L	1-phase L-N
Instantaneous	x 1.00	x 0.87	x 1.30
Minimum	x 1.00	x 1.80	x 3.20
Sustained	x 1.00	x 1.50	x 2.50
Max. sustained duration	10 sec.	5 sec.	2 sec.

All other times are unchanged

Note 3

Curves are drawn for Star (Wye) connected machines.

PI734F
Winding 312 / 0.8 Power Factor

RATINGS

Class - Temp Rise		Cont. F - 105/40°C				Cont. H - 125/40°C				Standby - 150/40°C				Standby - 163/27°C			
50Hz	Star (V)	380	400	415	440	380	400	415	440	380	400	415	440	380	400	415	440
	kVA	1880	1935	1935	1900	2020	2080	2080	2040	2105	2170	2170	2125	2165	2230	2230	2185
	kW	1504	1548	1548	1520	1616	1664	1664	1632	1684	1736	1736	1700	1732	1784	1784	1748
	Efficiency (%)	96.1	96.2	96.3	96.4	96.0	96.0	96.1	96.3	95.9	95.9	96.0	96.2	95.8	95.9	96.0	96.2
	kW Input	1565	1609	1607	1577	1683	1733	1732	1695	1756	1810	1808	1767	1808	1860	1858	1817

60Hz	Star (V)	416	440	460	480	416	440	460	480	416	440	460	480	416	440	460	480
	kVA	2180	2325	2370	2420	2340	2500	2550	2600	2435	2600	2650	2705	2505	2675	2730	2785
	kW	1744	1860	1896	1936	1872	2000	2040	2080	1948	2080	2120	2164	2004	2140	2184	2228
	Efficiency (%)	96.0	96.1	96.1	96.2	95.9	95.9	96.0	96.1	95.8	95.8	95.9	96.0	95.7	95.8	95.9	95.9
	kW Input	1817	1935	1973	2012	1952	2086	2125	2164	2033	2171	2211	2254	2094	2234	2277	2323

DIMENSIONS

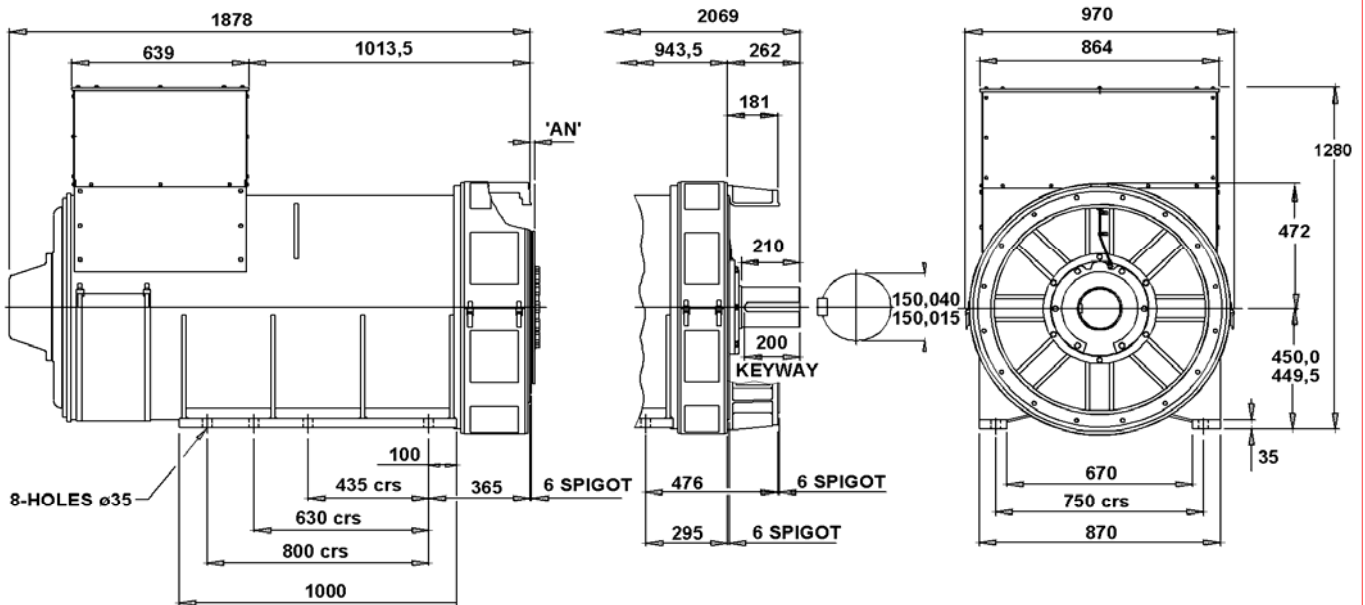

COUPLING DISC	'AN'
S.A.E No 18	15,7
S.A.E No 21	0
S.A.E No 24	0

1-BRG ADAPTORS
S.A.E No 0
S.A.E No 00

2-BRG ADAPTORS
S.A.E No 0
S.A.E No 00

QSK60-G7

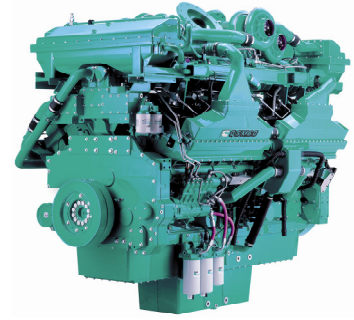

> Specification sheet

Our energy working for you.™



Description

The QSK60 is a V 16 cylinder engine with a 60 litre displacement. This Quantum series utilizes sophisticated electronics and premium engineering to provide outstanding performance levels, reliability and versatility for Standby, Prime and Continuous Power applications



This engine has been built to comply with CE certification.



This engine has been designed in facilities certified to ISO9001 and manufactured in facilities certified to ISO9001 or ISO9002.

Features

High pressure fuel pump, Modular Common Rail fuel System (MCRS) and state of the art integrated electronic control system provide superior performance, efficiency and diagnostics. The electronic fuel pumps deliver up to 1600 bar injection pressure and eliminate mechanical linkage adjustments. The new MCRS utilizes an electric priming pump which is integrated with the off-engine stage-1 fuel filter head and is controlled and powered by the engine ECM. The stage-2 fuel filters are mounted on-engine

CTT (Cummins Turbo Technologies) HX82/HX83 turbo-charging utilizes exhaust energy with greater efficiency for improved emissions and fuel consumption.

Low Temperature After-cooling - Two-pump Two-loop (2P2L)

Ferrous Cast Ductile Iron (FCD) Pistons - High strength design delivers superior durability.

G-Drive Integrated Design - Each component has been specifically developed and rigorously tested for G-Drive products, ensuring high performance, durability and reliability.

Service and Support - G-Drive products are backed by an uncompromising level of technical support and after sales service, delivered through a world class service network.

1500 rpm (50 Hz Ratings)

Gross Engine Output			Net Engine Output			Typical Generator Set Output					
Standby	Prime	Base	Standby	Prime	Base	Standby (ESP)		Prime (PRP)		Base (COP)	
kWm/BHP			kWm/BHP			kWe	kVA	kWe	kVA	kWe	kVA
1790/2399	1615/2165	1305/1749	1737/2329	1580/2119	1270/1703	1825	2000	1517	1825	1219	1524

1800 rpm (60 Hz Ratings)

Gross Engine Output			Net Engine Output			Typical Generator Set Output					
Standby	Prime	Base	Standby	Prime	Base	Standby (ESP)		Prime (PRP)		Base (COP)	
kWm/BHP			kWm/BHP			kWe	kVA	kWe	kVA	kWe	kVA
2180/2922	1975/2647	1740/2332	2120/2843	1937/2598	1702/2282	2000	2500	1825	2281	1633	2042



General Engine Data

Type	4 cycle, Turbocharged, After-cooled
Bore mm	159
Stroke mm	190
Displacement Litre	60.2
Cylinder Block	Cast iron, 16 cylinder
Battery Charging Alternator	55A
Starting Voltage	24V
Fuel System	Direct injection Cummins MCRS
Fuel Filter	Spin on fuel filters with water separator
Lube Oil Filter Type(s)	Spin on full flow filter
Lube Oil Capacity (l)	280
Flywheel Dimensions	SAE 0

Coolpac Performance Data

Cooling System Design	2 pump - 2 loop
Coolant Ratio	50% ethylene glycol; 50% water
Coolant Capacity (l)	Engine only – not applicable
Limiting Ambient Temp.**	
Fan Power	
Cooling System Air Flow (m ³ /s)**	
Air Cleaner Type	Dry replaceable element with restriction indicator

** @ 13 mm H₂O

Weight & Dimensions

Length mm	Width mm	Height mm	Weight (dry) kg
2781	1794	2155	7185

Fuel Consumption 1500 (50 Hz)

%	kWm	BHP	L/ph	US gal/ph
Standby Power				
100	1790	2399	415	109.5
Prime Power				
100	1615	2165	378	99.7
75	1211	1624	288	75.9
50	808	1083	200	52.9
25	404	541	115	30.3
Continuous Power				
100	1305	1749	309	81.6

Fuel Consumption 1800 (60 Hz)

%	kWm	BHP	L/ph	US gal/ph
Standby Power				
100	2180	2922	520	137.2
Prime Power				
100	1978	2647	471	124.2
75	1481	1985	360	95.1
50	987	1324	254	67.1
25	494	662	152	40.1
Continuous Power				
100	1740	2332	417	110

Ratings Definitions

Emergency Standby Power (ESP):

Applicable for supplying power to varying electrical load for the duration of power interruption of a reliable utility source. Emergency Standby Power (ESP) is in accordance with ISO 3046, AS 2789, DIN 6271 and BS 5514.

Limited-Time Running Power (LTP):

Applicable for supplying power to a constant electrical load for limited hours. Limited-Time Running Power (LTP) is in accordance with ISO 8528.

Prime Power (PRP):

Applicable for supplying power to varying electrical load for unlimited hours. Prime Power (PRP) is in accordance with ISO 8528. Ten percent overload capability is available in accordance with ISO 3046, AS 2789, DIN 6271 and BS 5514.

Base Load (Continuous) Power (COP):

Applicable for supplying power continuously to a constant electrical load for unlimited hours. Continuous Power (COP) in accordance with ISO 8528, ISO 3046, AS 2789, DIN6271 and BS 5514.

Cummins G-Drive Engines

Asia Pacific

10 Toh Guan Road
#07-01
TT International Tradepark
Singapore 608838
Phone 65 6417 2388
Fax 65 6417 2399

Europe, CIS, Middle East and Africa

Manston Park Columbus Ave
Manston Ramsgate
Kent CT12 5BF, UK
Phone 44 1843 255000
Fax 44 1843 255902

Latin America

Rua Jati, 310, Cumbica
Guarulhos, SP 07180-900
Brazil
Phone 55 11 2186 4552
Fax 55 11 2186 4729

Mexico

Cummins S. de R.L. de C.V.
Eje 122 No. 200 Zona Industrial
San Luis Potosi, S.L.P. 78090
Mexico
Phone 52 444 870 6700
Fax 52 444 870 6811

North America

1400 73rd Avenue N.E.
Minneapolis, MN 55432
USA
Phone 1 763 574 5000
USA Toll-free 1 877 769 7669
Fax 1 763 574 5298



PI734E - Technical Data Sheet

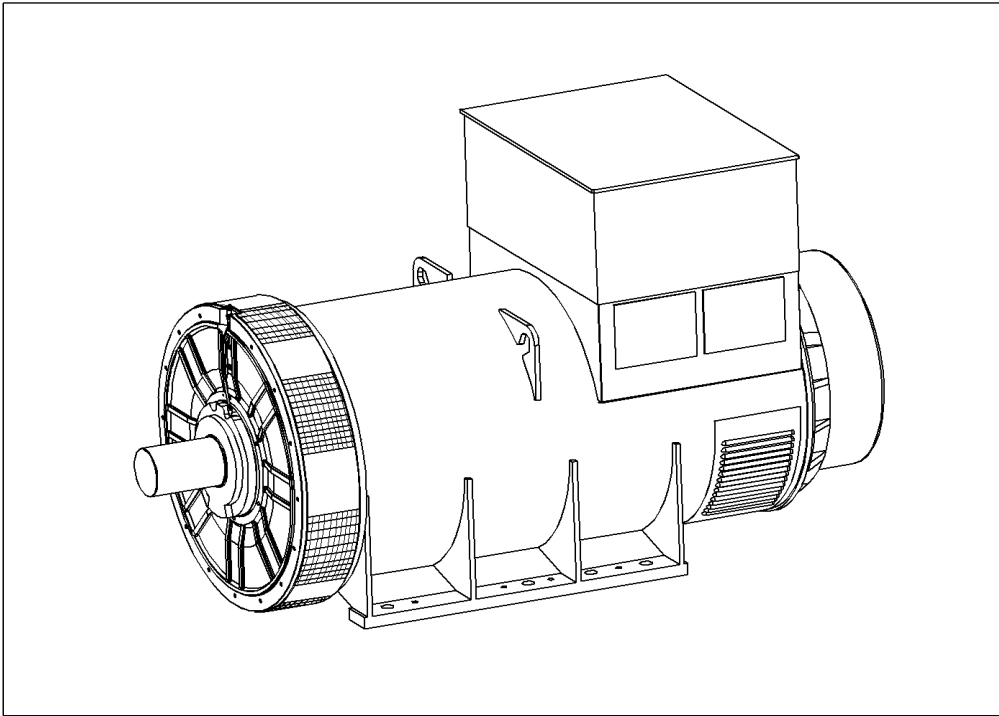

PI734E

SPECIFICATIONS & OPTIONS



STANDARDS

Newage Stamford industrial generators meet the requirements of BS EN 60034 and the relevant sections of other national and international standards such as BS5000, VDE 0530, NEMA MG1-32, IEC60034, CSA C22.2-100, AS1359.

Other standards and certifications can be considered on request.

DESCRIPTION

The STAMFORD PI range of synchronous ac generators are brushless with a rotating field. They are separately excited by the STAMFORD Permanent Magnet Generator (PMG). This is a shaft mounted, high frequency, pilot exciter which provides a constant supply of clean power via the Automatic Voltage Regulator (AVR) to the main exciter. The main exciter output is fed to the main rotor, through a full wave bridge rectifier, protected by surge suppression.

VOLTAGE REGULATORS

The PI range generators, complete with a PMG, are available with one of two AVRs. Each AVR has soft start voltage build up and built in protection against sustained over-excitation, which will de-excite the generator after a minimum of 8 seconds.

Underspeed protection (UFRO) is also provided on both AVRs. The UFRO will reduce the generator output voltage proportional to the speed of the generator below a pre-settable level.

The **MX341 AVR** is two phase sensed with a voltage regulation of $\pm 1\%$. (see the note on regulation).

The **MX321 AVR** is 3 phase rms sensed with a voltage regulation of 0.5% rms (see the note on regulation). The UFRO circuit has adjustable slope and dwell for controlled recovery from step loads. An over voltage protection circuit will shutdown the output device of the AVR, it can also trip an optional excitation circuit breaker if required. As an option, short circuit current limiting is available with the addition of current transformers.

Both the MX341 and the MX321 need a generator mounted current transformer to provide quadrature droop characteristics for load sharing during parallel operation. Provision is also made for the connection of the STAMFORD power factor controller, for embedded applications, and a remote voltage trimmer.

WINDINGS & ELECTRICAL PERFORMANCE

All generator stators are wound to 2/3 pitch. This eliminates triplen (3rd, 9th, 15th ...) harmonics on the voltage waveform and is found to be the optimum design for trouble-free supply of non-linear loads. The 2/3 pitch design avoids excessive neutral currents sometimes seen with higher winding pitches. A fully connected damper winding reduces oscillations during paralleling. This winding, with the 2/3 pitch and carefully selected pole and tooth designs, ensures very low levels of voltage waveform distortion.

TERMINALS & TERMINAL BOX

Standard generators feature a main stator with 6 ends brought out to the terminals, which are mounted on the frame at the non-drive end of the generator. A sheet steel terminal box contains the AVR and provides ample space for the customers' wiring and gland arrangements. It has removable panels for easy access.

SHAFT & KEYS

All generator rotors are dynamically balanced to better than BS6861:Part 1 Grade 2.5 for minimum vibration in operation. Two bearing generators are balanced with a half key.

INSULATION/IMPREGNATION

The insulation system is class 'H', and meets the requirements of UL1446.

All wound components are impregnated with materials and processes designed specifically to provide the high build required for static windings and the high mechanical strength required for rotating components.

QUALITY ASSURANCE

Generators are manufactured using production procedures having a quality assurance level to BS EN ISO 9001.

NOTE ON REGULATION

The stated voltage regulation may not be maintained in the presence of certain radio transmitted signals. Any change in performance will fall within the limits of Criteria 'B' of EN 61000-6-2:2001. At no time will the steady-state voltage regulation exceed 2%.

Note: Continuous development of our products entitles us to change specification details without notice, therefore they must not be regarded as binding.

Front cover drawing is typical of the product range.

PI734E
WINDING 312

CONTROL SYSTEM	SEPARATELY EXCITED BY P.M.G.		
A.V.R.	MX341	MX321	
VOLTAGE REGULATION	± 1 %	± 0.5 %	With 4% ENGINE GOVERNING
SUSTAINED SHORT CIRCUIT	REFER TO SHORT CIRCUIT DECREMENT CURVES (page 7)		

INSULATION SYSTEM	CLASS H
PROTECTION	IP23
RATED POWER FACTOR	0.8
STATOR WINDING	DOUBLE LAYER LAP
WINDING PITCH	TWO THIRDS
WINDING LEADS	6
MAIN STATOR RESISTANCE	0.00093 Ohms PER PHASE AT 22°C STAR CONNECTED
MAIN ROTOR RESISTANCE	2.17 Ohms at 22°C
EXCITER STATOR RESISTANCE	17.5 Ohms at 22°C
EXCITER ROTOR RESISTANCE	0.048 Ohms PER PHASE AT 22°C
R.F.I. SUPPRESSION	BS EN 61000-6-2 & BS EN 61000-6-4, VDE 0875G, VDE 0875N. refer to factory for others
WAVEFORM DISTORTION	NO LOAD < 1.5% NON-DISTORTING BALANCED LINEAR LOAD < 5.0%
MAXIMUM OVERSPEED	2250 Rev/Min
BEARING DRIVE END	BALL. 6228 C3
BEARING NON-DRIVE END	BALL. 6319 C3

	1 BEARING	2 BEARING
WEIGHT COMP. GENERATOR	3556 kg	3506 kg
WEIGHT WOUND STATOR	1747 kg	1747 kg
WEIGHT WOUND ROTOR	1494 kg	1432 kg
WR ² INERTIA	45.49 kgm ²	44.4891 kgm ²
SHIPPING WEIGHTS in a crate	3629kg	3575kg
PACKING CRATE SIZE	216 x 105 x 154(cm)	216 x 105 x 154(cm)

	50 Hz				60 Hz			
TELEPHONE INTERFERENCE	THF<2%				TIF<50			
COOLING AIR	2.69 m ³ /sec 5700 cfm				3.45 m ³ /sec 7300 cfm			
VOLTAGE STAR	380/220	400/231	415/240	440/254	416/240	440/254	460/266	480/277
KVA BASE RATING FOR REACTANCE VALUES	1845	1900	1900	1865	2070	2210	2255	2300
X _d DIR. AXIS SYNCHRONOUS	3.18	2.96	2.75	2.40	3.84	3.67	3.42	3.21
X' _d DIR. AXIS TRANSIENT	0.19	0.18	0.17	0.15	0.23	0.22	0.21	0.19
X'' _d DIR. AXIS SUBTRANSIENT	0.14	0.13	0.12	0.11	0.17	0.16	0.15	0.14
X _q QUAD. AXIS REACTANCE	2.04	1.90	1.76	1.54	2.47	2.36	2.20	2.06
X'' _q QUAD. AXIS SUBTRANSIENT	0.29	0.27	0.25	0.22	0.35	0.33	0.31	0.29
X _L LEAKAGE REACTANCE	0.04	0.03	0.03	0.03	0.04	0.04	0.04	0.04
X ₂ NEGATIVE SEQUENCE	0.20	0.19	0.17	0.15	0.24	0.23	0.22	0.20
X ₀ ZERO SEQUENCE	0.02	0.02	0.02	0.02	0.03	0.03	0.03	0.03

REACTANCES ARE SATURATED

VALUES ARE PER UNIT AT RATING AND VOLTAGE INDICATED

T' _d TRANSIENT TIME CONST.	0.149s
T'' _d SUB-TRANSTIME CONST.	0.02s
T' _{do} O.C. FIELD TIME CONST.	2.46s
T _a ARMATURE TIME CONST.	0.02s
SHORT CIRCUIT RATIO	1/X _d

**50
Hz**

PI734E
Winding 312



THREE PHASE EFFICIENCY CURVES

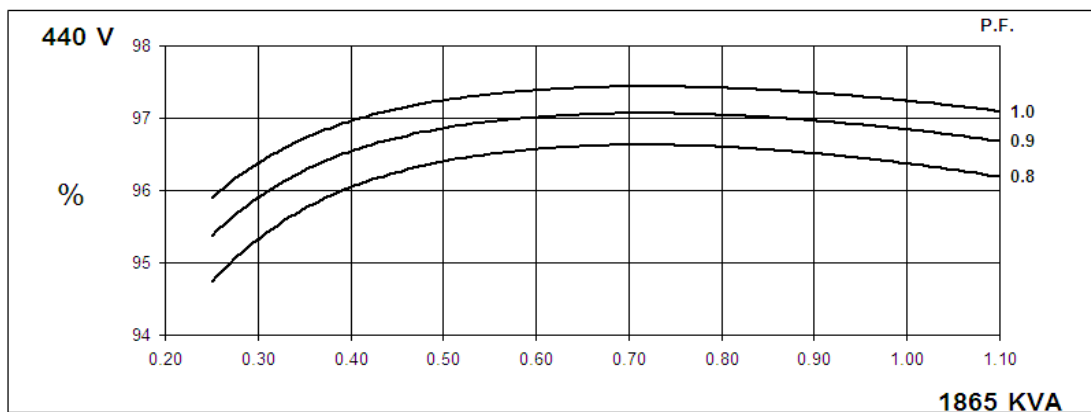
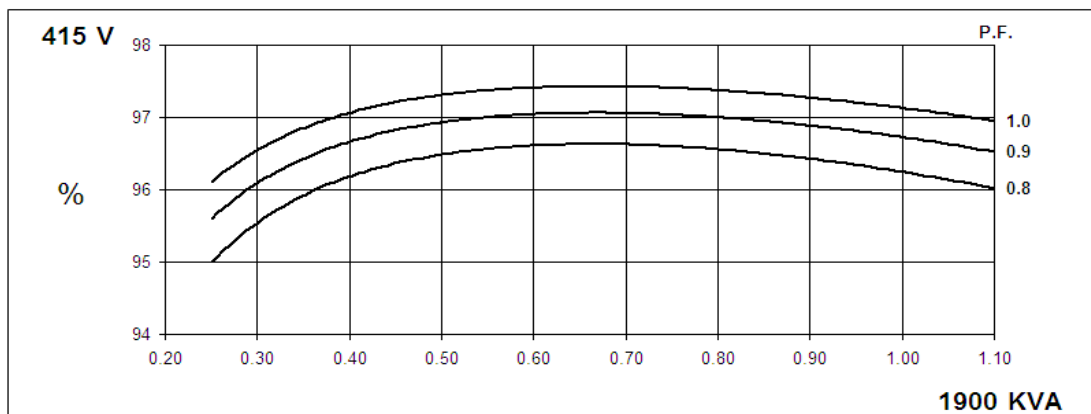
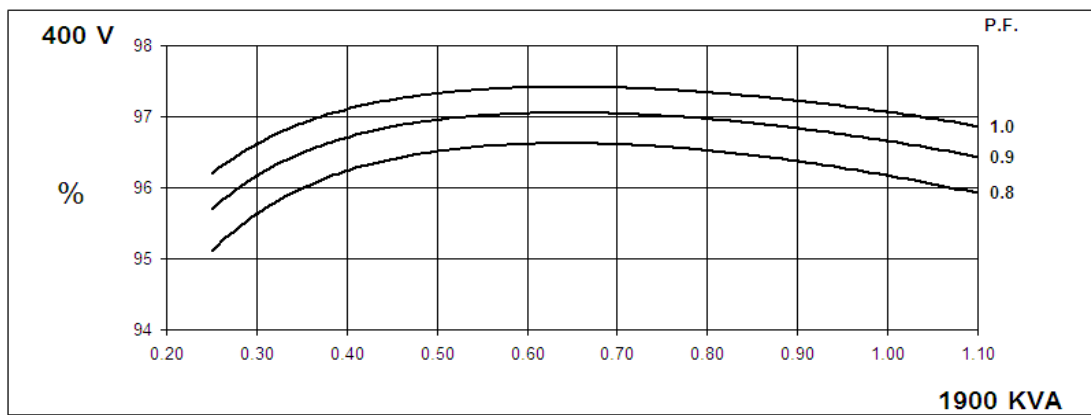
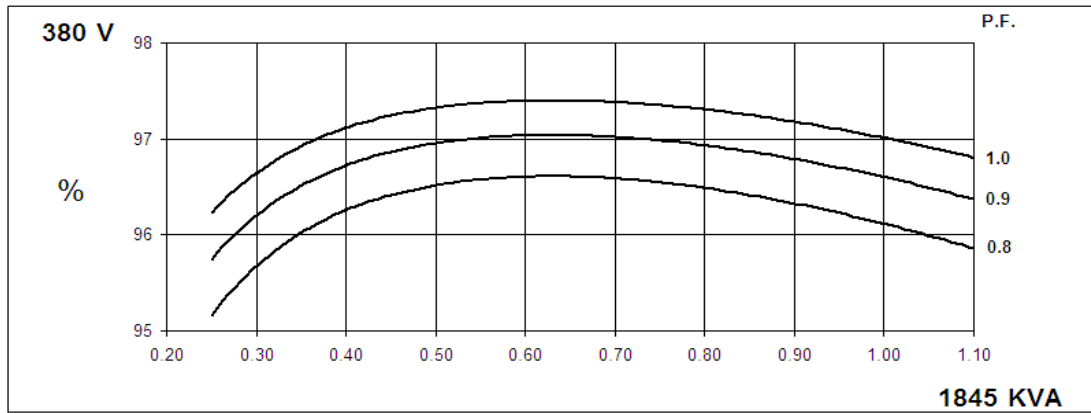

THREE PHASE EFFICIENCY CURVES

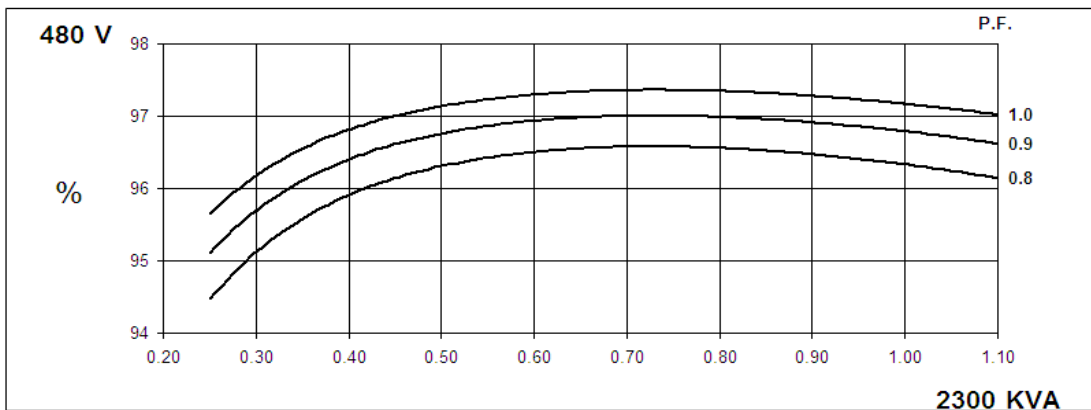
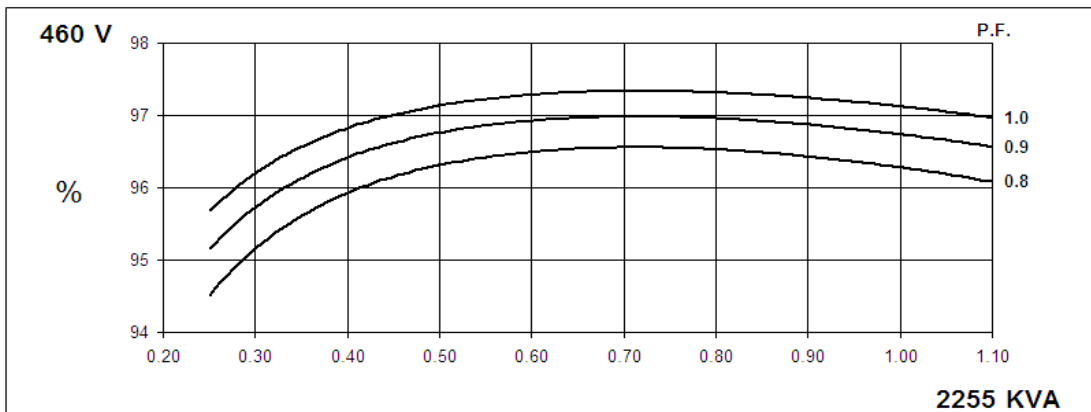
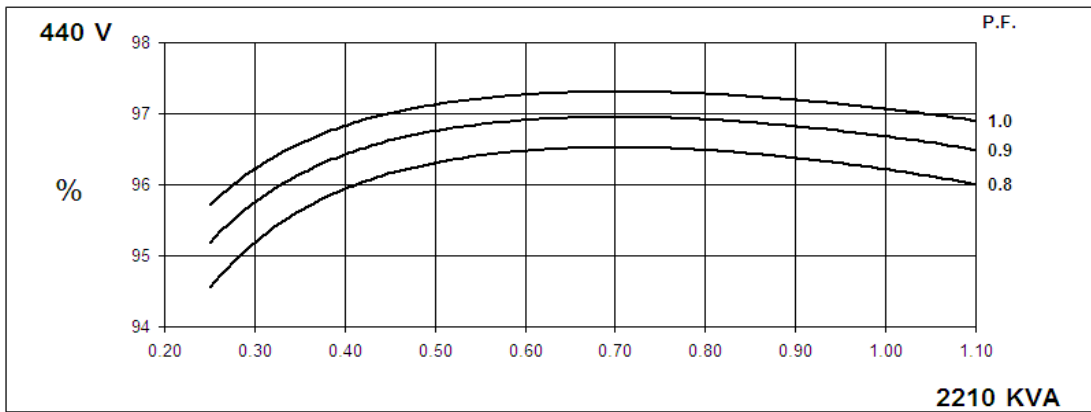
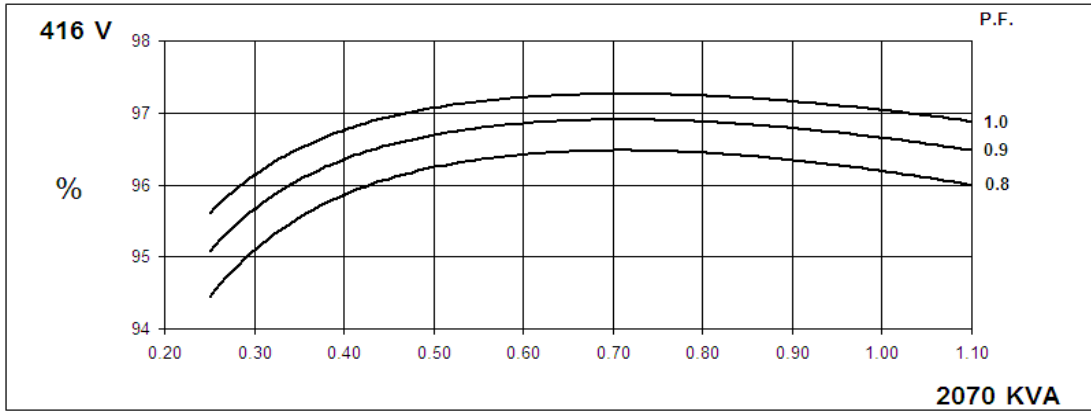

PI734E

Winding 312



Locked Rotor Motor Starting Curve

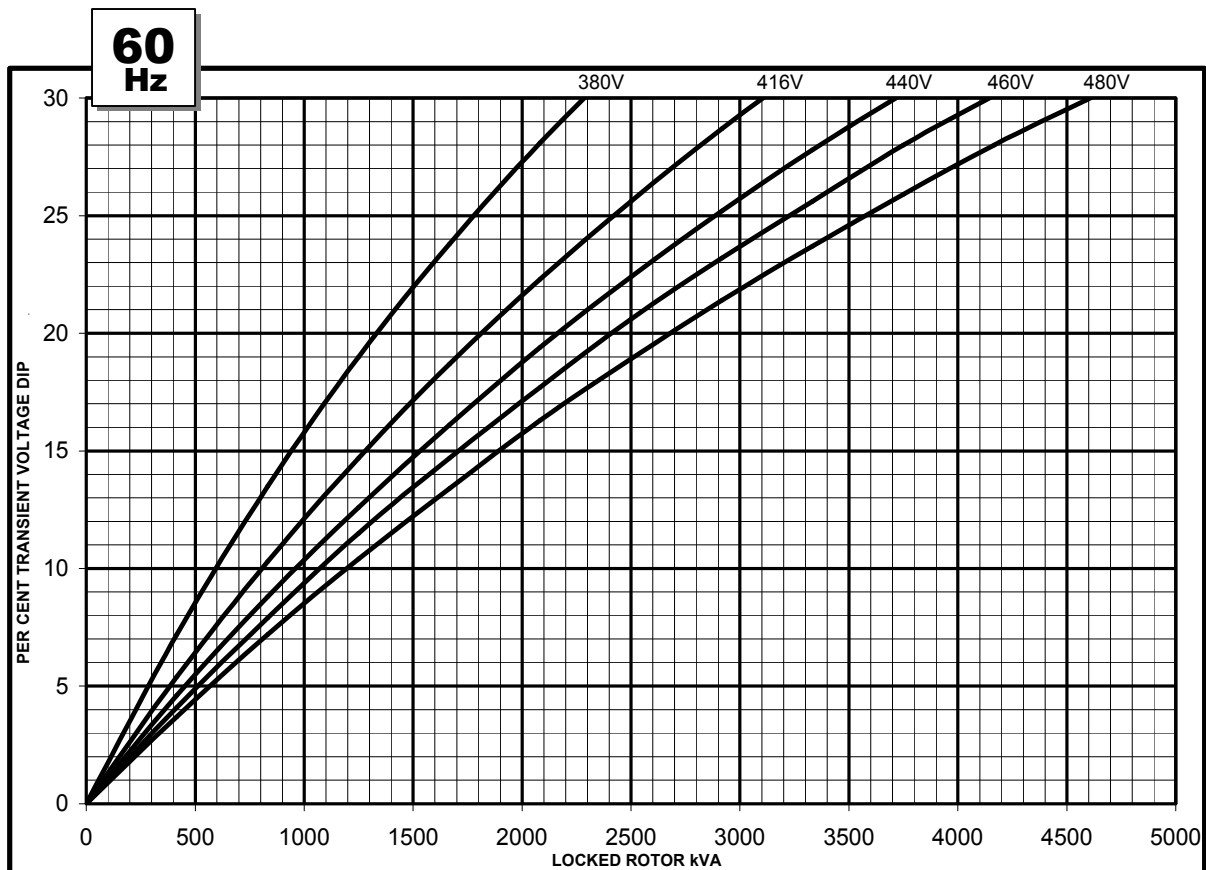
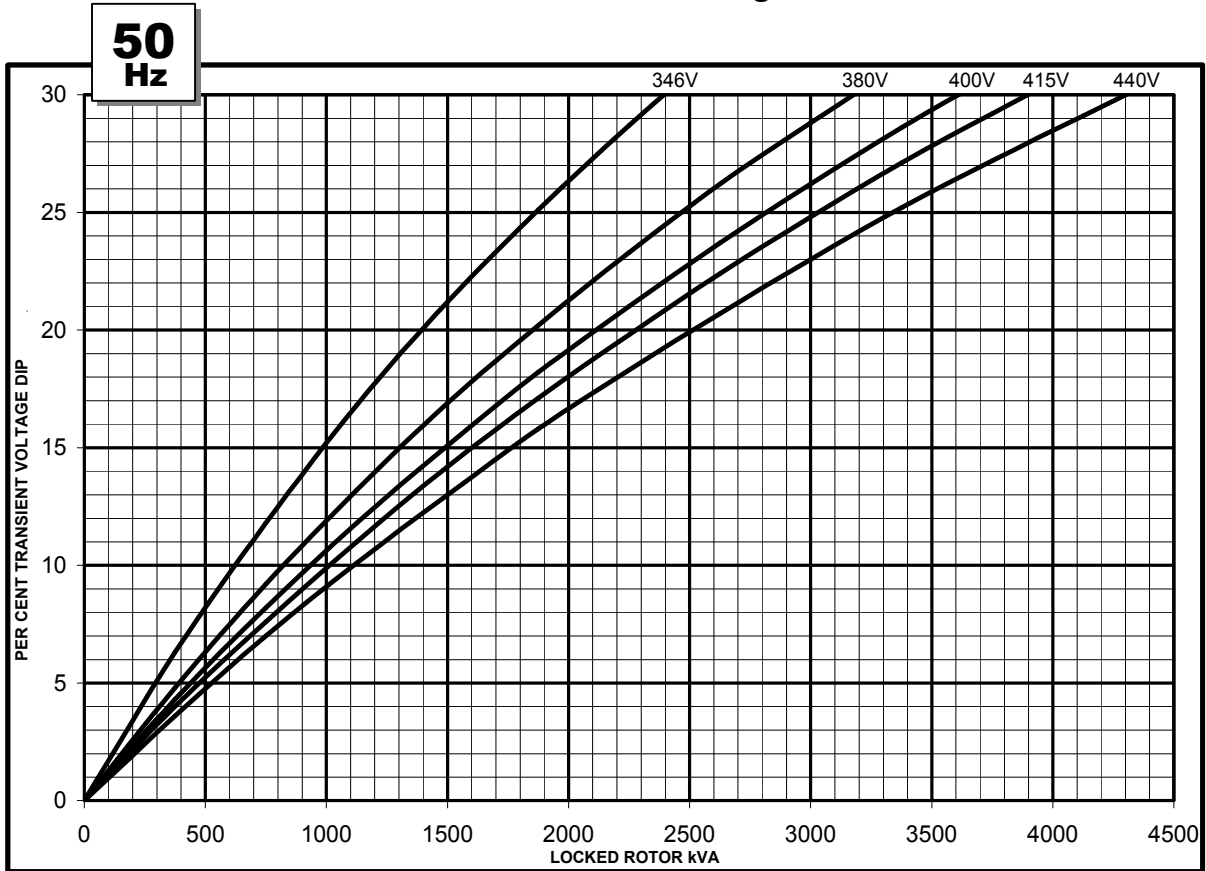

**Three-phase Short Circuit Decrement Curve. No-load Excitation at Rated Speed
Based on star (wye) connection.**

**50
Hz**

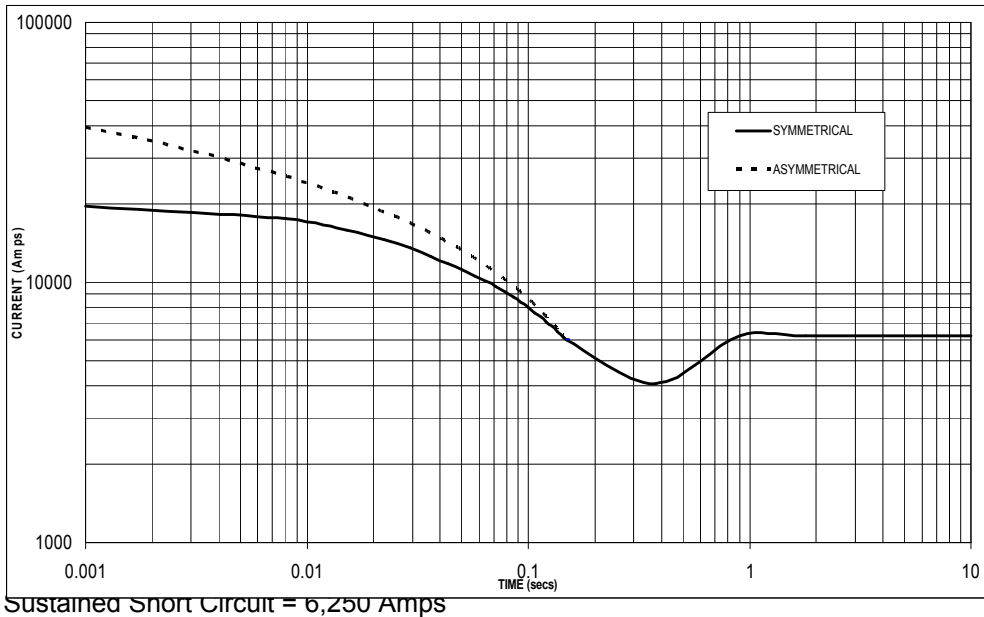

**60
Hz**

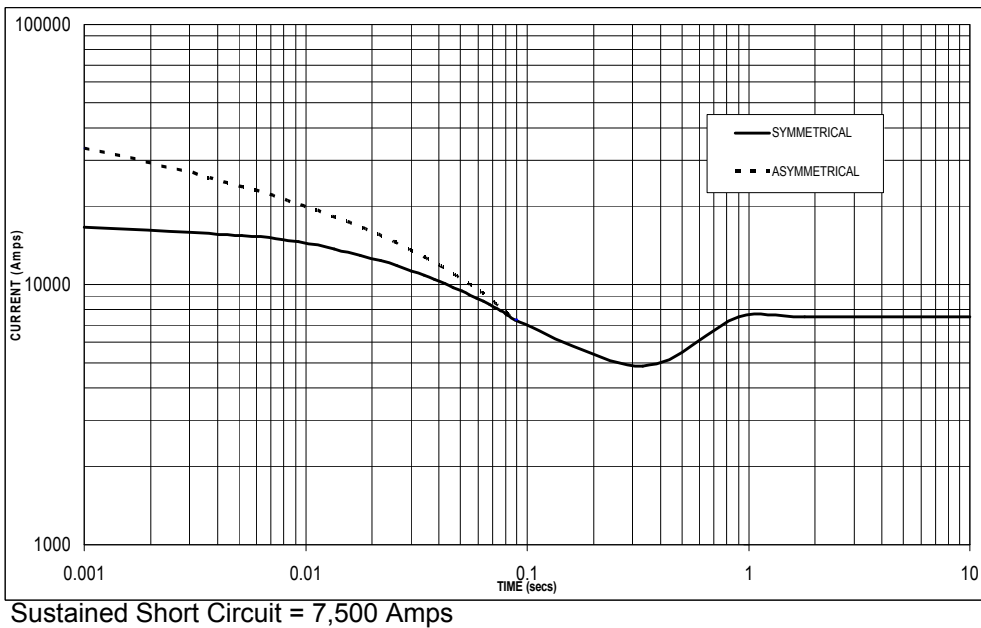

Note 1

The following multiplication factors should be used to adjust the values from curve between time 0.001 seconds and the minimum current point in respect of nominal operating voltage :

50Hz		60Hz	
Voltage	Factor	Voltage	Factor
380v	x 1.00	416v	x 1.00
400v	x 1.05	440v	x 1.06
415v	x 1.09	460v	x 1.10
440v	x 1.16	480v	x 1.15

The sustained current value is constant irrespective of voltage level

Note 2

The following multiplication factor should be used to convert the values calculated in accordance with NOTE 1 to those applicable to the various types of short circuit :

	3-phase	2-phase L-L	1-phase L-N
Instantaneous	x 1.00	x 0.87	x 1.30
Minimum	x 1.00	x 1.80	x 3.20
Sustained	x 1.00	x 1.50	x 2.50
Max. sustained duration	10 sec.	5 sec.	2 sec.

All other times are unchanged

Note 3

Curves are drawn for Star (Wye) connected machines.

PI734E

Winding 312 / 0.8 Power Factor



RATINGS

Class - Temp Rise		Cont. F - 105/40°C				Cont. H - 125/40°C				Standby - 150/40°C				Standby - 163/27°C			
50Hz	Star (V)	380	400	415	440	380	400	415	440	380	400	415	440	380	400	415	440
	kVA	1715	1770	1770	1735	1845	1900	1900	1865	1920	1980	1980	1940	1975	2035	2035	1995
	kW	1372	1416	1416	1388	1476	1520	1520	1492	1536	1584	1584	1552	1580	1628	1628	1596
	Efficiency (%)	96.3	96.3	96.4	96.5	96.1	96.2	96.2	96.4	96.0	96.1	96.2	96.3	95.9	96.0	96.1	96.2
	kW Input	1425	1470	1469	1438	1536	1580	1580	1548	1600	1648	1647	1612	1648	1696	1694	1659

60Hz	Star (V)	416	440	460	480	416	440	460	480	416	440	460	480	416	440	460	480
	kVA	1935	2055	2100	2140	2070	2210	2255	2300	2155	2300	2345	2395	2215	2365	2415	2465
	kW	1548	1644	1680	1712	1656	1768	1804	1840	1724	1840	1876	1916	1772	1892	1932	1972
	Efficiency (%)	96.3	96.3	96.4	96.4	96.2	96.2	96.3	96.3	96.1	96.1	96.2	96.3	96.1	96.1	96.1	96.2
	kW Input	1607	1707	1743	1776	1721	1838	1873	1911	1794	1915	1950	1990	1844	1969	2010	2050

DIMENSIONS

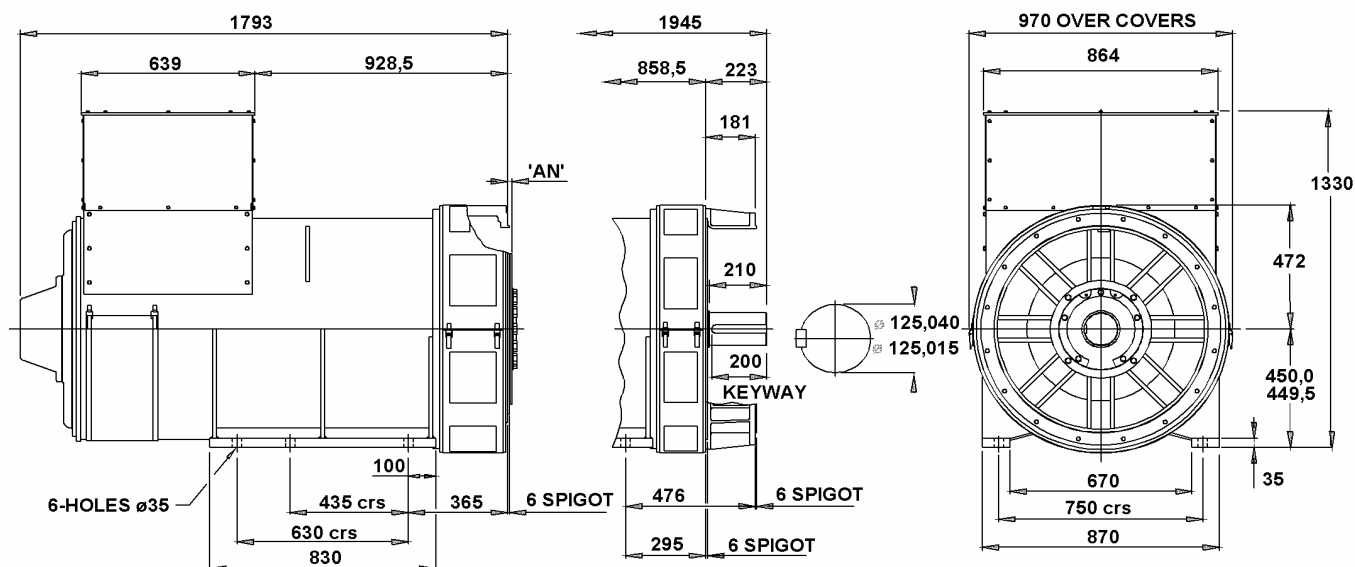

COUPLING DISC	'AN'
S.A.E No 18	15,7
S.A.E No 21	0
S.A.E No 24	0

1-BRG ADAPTORS
S.A.E No 0
S.A.E No 00

2-BRG ADAPTORS
S.A.E No 0
S.A.E No 00



Barnack Road • Stamford • Lincolnshire • PE9 2NB
Tel: 00 44 (0)1780 484000 • Fax: 00 44 (0)1780 484100

QSK60-G4

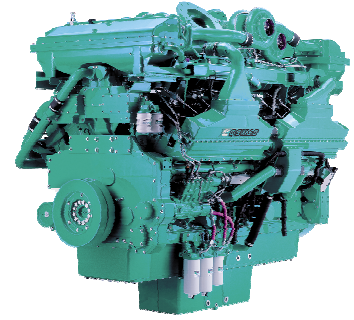

> Specification sheet

Our energy working for you.™



Description

The QSK60 is a V 16 cylinder engine with a 60 litre displacement. This Quantum series utilizes sophisticated electronics and premium engineering to provide outstanding performance levels, reliability and versatility for Standby, Prime and Continuous Power applications.



This engine has been built to comply with CE certification.



This engine has been designed in facilities certified to ISO9001 and manufactured in facilities certified to ISO9001 or ISO9002.

Features

Cummins High Pressure Injection (HPI) PT full authority electronic fuel system. The HPI PT fuel system is managed by a G-Drive Governor Control System (GCS) controller, which is provided for off-engine mounting in the genset control panel. The Quantum Control has a specific fuel system board to interface with the HPI-PT fuel system and provides an Engine Protection package giving greater customer flexibility and cost effective alternatives in the control design and the benefits of Full Authority electronic control.

CTT (Cummins Turbo Technologies) HX82/HX83 turbo-charging utilizes exhaust energy with greater efficiency for improved emissions and fuel consumption.

Low Temperature After-cooling - Two-pump Two-loop (2P2L)

Ferrous Cast Ductile Iron (FCD) Pistons - High strength design delivers superior durability.

G-Drive Integrated Design - Each component has been specifically developed and rigorously tested for G-Drive products, ensuring high performance, durability and reliability.

Service and Support - G-Drive products are backed by an uncompromising level of technical support and after sales service, delivered through a world class service network.

Coolpac Integrated Design - Products are supplied complete with cooling package and air cleaner kit for a complete power package. Each component has been specifically developed and rigorously tested for G-Drive products, ensuring high performance, durability and reliability.

1500 rpm (50 Hz Ratings)

Gross Engine Output			Net Engine Output			Typical Generator Set Output					
Standby	Prime	Base	Standby	Prime	Base	Standby (ESP)		Prime (PRP)		Base (COP)	
kWm/BHP			kWm/BHP			kWe	kVA	kWe	kVA	kWe	kVA
1915/2567	1730/2319	1415/1897	1861/2345	1695/2273	1380/1851	1800	2250	1636	2045	1325	1650



General Engine Data

Type	4 cycle, Turbocharged, After-cooled
Bore mm	159
Stroke mm	190
Displacement Litre	60.2
Cylinder Block	Cast iron, 16 cylinder
Battery Charging Alternator	55A
Starting Voltage	24V
Fuel System	Direct injection Cummins HPI
Fuel Filter	Spin on fuel filters with water separator
Lube Oil Filter Type(s)	Spin on full flow filter
Lube Oil Capacity (l)	280
Flywheel Dimensions	SAE 0

Coolpac Performance Data

Cooling System Design	2 pump - 2 loop
Coolant Ratio	50% ethylene glycol; 50% water
Coolant Capacity (l)	242.0
Limiting Ambient Temp.**	54.9
Fan Power	45.0
Cooling System Air Flow (m ³ /s)**	29.6
Air Cleaner Type	Dry replaceable element with restriction indicator

** @ 13 mm H₂O

Weight & Dimensions

Length	Width	Height	Weight (dry)
mm	mm	mm	kg
4123	2494	3296	9685

Fuel Consumption 1500 (50 Hz)

%	kWm	BHP	L/ph	US gal/ph
Standby Power				
100	1915	2567	437	115.3
Prime Power				
100	1730	2319	394	103.9
75	1298	1739	291	76.9
50	865	1160	200	52.7
25	433	580	114	30.1
Continuous Power				
100	1415	1897	320	84.4

Cummins G-Drive Engines

Asia Pacific

10 Toh Guan Road
#07-01
TT International Tradepark
Singapore 608838
Phone 65 6417 2388
Fax 65 6417 2399

Europe, CIS, Middle East and Africa

Manston Park Columbus Ave
Manston Ramsgate
Kent CT12 5BF, UK
Phone 44 1843 255000
Fax 44 1843 255902

Latin America

Rua Jati, 310, Cumbica
Guarulhos, SP 07180-900
Brazil
Phone 55 11 2186 4552
Fax 55 11 2186 4729

Mexico

Cummins S. de R.L. de C.V.
Eje 122 No. 200 Zona Industrial
San Luis Potosí, S.L.P. 78090
Mexico
Phone 52 444 870 6700
Fax 52 444 870 6811

North America

1400 73rd Avenue N.E.
Minneapolis, MN 55432
USA
Phone 1 763 574 5000
USA Toll-free 1 877 769 7669
Fax 1 763 574 5298

Ratings Definitions

Emergency Standby Power (ESP):

Applicable for supplying power to varying electrical load for the duration of power interruption of a reliable utility source. Emergency Standby Power (ESP) is in accordance with ISO 3046, AS 2789, DIN 6271 and BS 5514.

Limited-Time Running Power (LTP):

Applicable for supplying power to a constant electrical load for limited hours. Limited-Time Running Power (LTP) is in accordance with ISO 8528.

Prime Power (PRP):

Applicable for supplying power to varying electrical load for unlimited hours. Prime Power (PRP) is in accordance with ISO 8528. Ten percent overload capability is available in accordance with ISO 3046, AS 2789, DIN 6271 and BS 5514.

Base Load (Continuous) Power (COP):

Applicable for supplying power continuously to a constant electrical load for unlimited hours. Continuous Power (COP) in accordance with ISO 8528, ISO 3046, AS 2789, DIN6271 and BS 5514.



STAMFORD[®]

PI734F - Technical Data Sheet

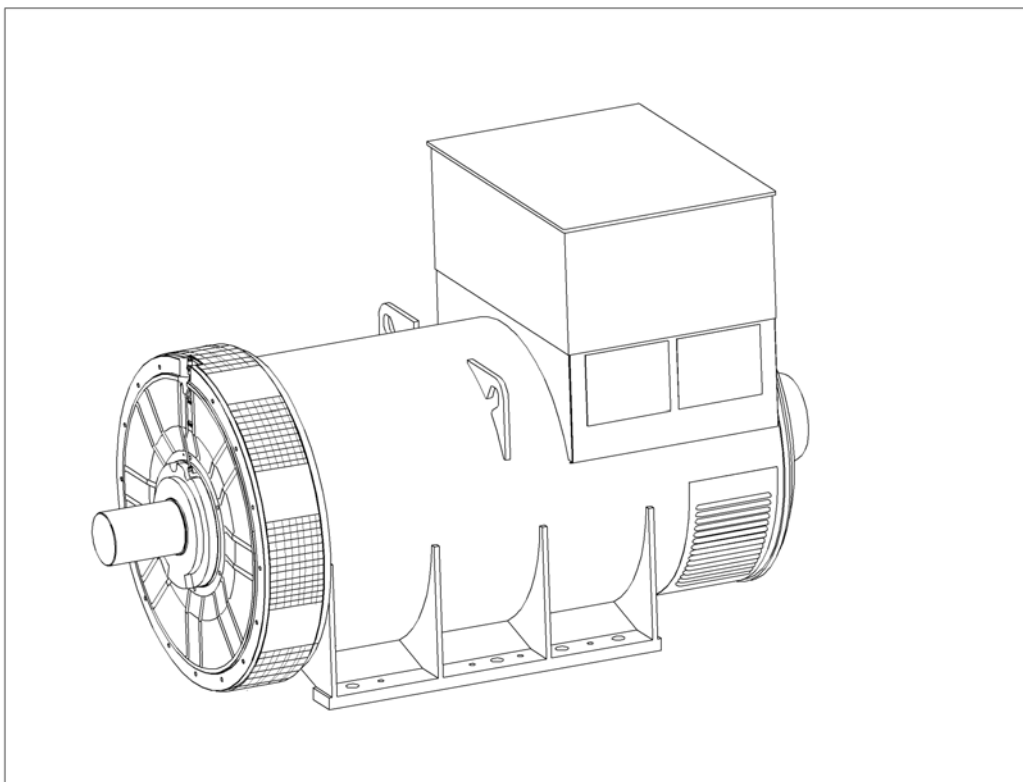

PI734F

SPECIFICATIONS & OPTIONS

STANDARDS

Newage Stamford industrial generators meet the requirements of BS EN 60034 and the relevant sections of other national and international standards such as BS5000, VDE 0530, NEMA MG1-32, IEC60034, CSA C22.2-100, AS1359.

Other standards and certifications can be considered on request.

DESCRIPTION

The STAMFORD PI range of synchronous ac generators are brushless with a rotating field. They are separately excited by the STAMFORD Permanent Magnet Generator (PMG). This is a shaft mounted, high frequency, pilot exciter which provides a constant supply of clean power via the Automatic Voltage Regulator (AVR) to the main exciter. The main exciter output is fed to the main rotor, through a full wave bridge rectifier, protected by surge suppression.

VOLTAGE REGULATORS

The PI range generators, complete with a PMG, are available with one of two AVRs. Each AVR has soft start voltage build up and built in protection against sustained over-excitation, which will de-excite the generator after a minimum of 8 seconds.

Underspeed protection (UFRO) is also provided on both AVRs. The UFRO will reduce the generator output voltage proportional to the speed of the generator below a pre-settable level.

The **MX341 AVR** is two phase sensed with a voltage regulation of $\pm 1\%$. (see the note on regulation).

The **MX321 AVR** is 3 phase rms sensed with a voltage regulation of 0.5% rms (see the note on regulation). The UFRO circuit has adjustable slope and dwell for controlled recovery from step loads. An over voltage protection circuit will shutdown the output device of the AVR, it can also trip an optional excitation circuit breaker if required. As an option, short circuit current limiting is available with the addition of current transformers.

Both the MX341 and the MX321 need a generator mounted current transformer to provide quadrature droop characteristics for load sharing during parallel operation. Provision is also made for the connection of the STAMFORD power factor controller, for embedded applications, and a remote voltage trimmer.

WINDINGS & ELECTRICAL PERFORMANCE

All generator stators are wound to 2/3 pitch. This eliminates triplen (3rd, 9th, 15th ...) harmonics on the voltage waveform and is found to be the optimum design for trouble-free supply of non-linear loads. The 2/3 pitch design avoids excessive neutral currents sometimes seen with higher winding pitches. A fully connected damper winding reduces oscillations during paralleling. This winding, with the 2/3 pitch and carefully selected pole and tooth designs, ensures very low levels of voltage waveform distortion.

TERMINALS & TERMINAL BOX

Standard generators feature a main stator with 6 ends brought out to the terminals, which are mounted on the frame at the non-drive end of the generator. A sheet steel terminal box contains the AVR and provides ample space for the customers' wiring and gland arrangements. It has removable panels for easy access.

SHAFT & KEYS

All generator rotors are dynamically balanced to better than BS6861:Part 1 Grade 2.5 for minimum vibration in operation. Two bearing generators are balanced with a half key.

INSULATION/IMPREGNATION

The insulation system is class 'H', and meets the requirements of UL1446.

All wound components are impregnated with materials and processes designed specifically to provide the high build required for static windings and the high mechanical strength required for rotating components.

QUALITY ASSURANCE

Generators are manufactured using production procedures having a quality assurance level to BS EN ISO 9001.

NOTE ON REGULATION

The stated voltage regulation may not be maintained in the presence of certain radio transmitted signals. Any change in performance will fall within the limits of Criteria 'B' of EN 61000-6-2:2001. At no time will the steady-state voltage regulation exceed 2%.

Note: Continuous development of our products entitles us to change specification details without notice, therefore they must not be regarded as binding.

Front cover drawing is typical of the product range.

PI734F

WINDING 312

STAMFORD

CONTROL SYSTEM	SEPARATELY EXCITED BY P.M.G.		
A.V.R.	MX341	MX321	
VOLTAGE REGULATION	± 1%	± 0.5 %	With 4% ENGINE GOVERNING
SUSTAINED SHORT CIRCUIT	REFER TO SHORT CIRCUIT DECREMENT CURVES (page 7)		

INSULATION SYSTEM	CLASS H							
PROTECTION	IP23							
RATED POWER FACTOR	0.8							
STATOR WINDING	DOUBLE LAYER LAP							
WINDING PITCH	TWO THIRDS							
WINDING LEADS	6							
MAIN STATOR RESISTANCE	0.00076 Ohms PER PHASE AT 22°C STAR CONNECTED							
MAIN ROTOR RESISTANCE	2.31 Ohms at 22°C							
EXCITER STATOR RESISTANCE	17.5 Ohms at 22°C							
EXCITER ROTOR RESISTANCE	0.063 Ohms PER PHASE AT 22°C							
R.F.I. SUPPRESSION	BS EN 61000-6-2 & BS EN 61000-6-4, VDE 0875G, VDE 0875N. refer to factory for others							
WAVEFORM DISTORTION	NO LOAD < 1.5% NON-DISTORTING BALANCED LINEAR LOAD < 5.0%							
MAXIMUM OVERSPEED	2250 Rev/Min							
BEARING DRIVE END	BALL. 6232 C3							
BEARING NON-DRIVE END	BALL. 6319 C3							
	1 BEARING			2 BEARING				
WEIGHT COMP. GENERATOR	3840 kg			3807 kg				
WEIGHT WOUND STATOR	1908 kg			1908 kg				
WEIGHT WOUND ROTOR	1609 kg			1565 kg				
WR ² INERTIA	49.3409 kgm ²			48.424 kgm ²				
SHIPPING WEIGHTS in a crate	3913kg			3876kg				
PACKING CRATE SIZE	216 x 105 x 154(cm)			216 x 105 x 154(cm)				
	50 Hz			60 Hz				
TELEPHONE INTERFERENCE	THF<2%			TIF<50				
COOLING AIR	2.69 m ³ /sec 5700 cfm			3.45 m ³ /sec 7300 cfm				
VOLTAGE STAR	380/220	400/231	415/240	440/254	416/240	440/254	460/266	480/277
kVA BASE RATING FOR REACTANCE VALUES	2020	2080	2080	2040	2340	2500	2550	2600
X _d DIR. AXIS SYNCHRONOUS	2.93	2.73	2.53	2.21	3.54	3.38	3.16	2.96
X' _d DIR. AXIS TRANSIENT	0.18	0.17	0.15	0.13	0.21	0.20	0.19	0.18
X'' _d DIR. AXIS SUBTRANSIENT	0.13	0.12	0.11	0.10	0.16	0.15	0.14	0.13
X _q QUAD. AXIS REACTANCE	1.89	1.75	1.63	1.42	2.28	2.18	2.03	1.90
X'' _q QUAD. AXIS SUBTRANSIENT	0.26	0.25	0.23	0.20	0.32	0.31	0.29	0.27
X _L LEAKAGE REACTANCE	0.03	0.03	0.03	0.03	0.04	0.04	0.04	0.03
X ₂ NEGATIVE SEQUENCE	0.19	0.17	0.16	0.14	0.23	0.22	0.20	0.19
X ₀ ZERO SEQUENCE	0.02	0.02	0.02	0.02	0.03	0.03	0.02	0.02
REACTANCES ARE SATURATED				VALUES ARE PER UNIT AT RATING AND VOLTAGE INDICATED				
T' _d TRANSIENT TIME CONST.	0.154s							
T'' _d SUB-TRANSTIME CONST.	0.02s							
T' _{do} O.C. FIELD TIME CONST.	2.54s							
T _a ARMATURE TIME CONST.	0.02s							
SHORT CIRCUIT RATIO	1/X _d							

50
Hz

PI734F
Winding 312

STAMFORD

THREE PHASE EFFICIENCY CURVES

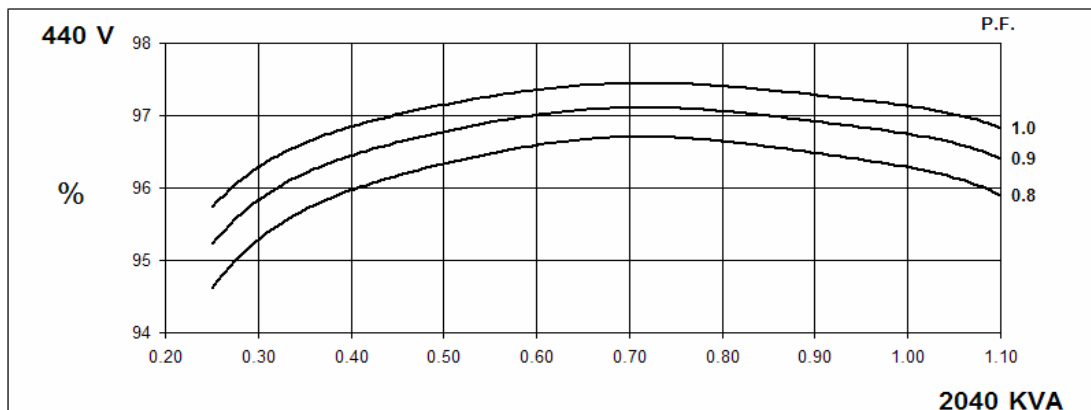
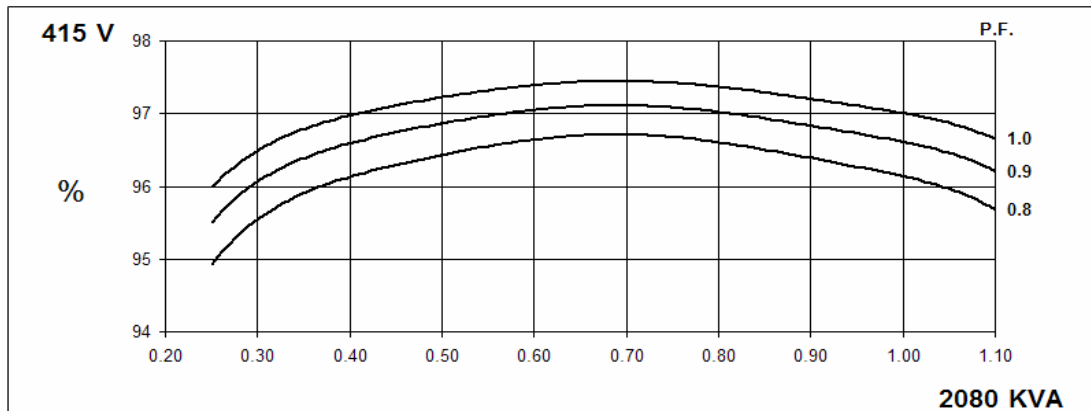
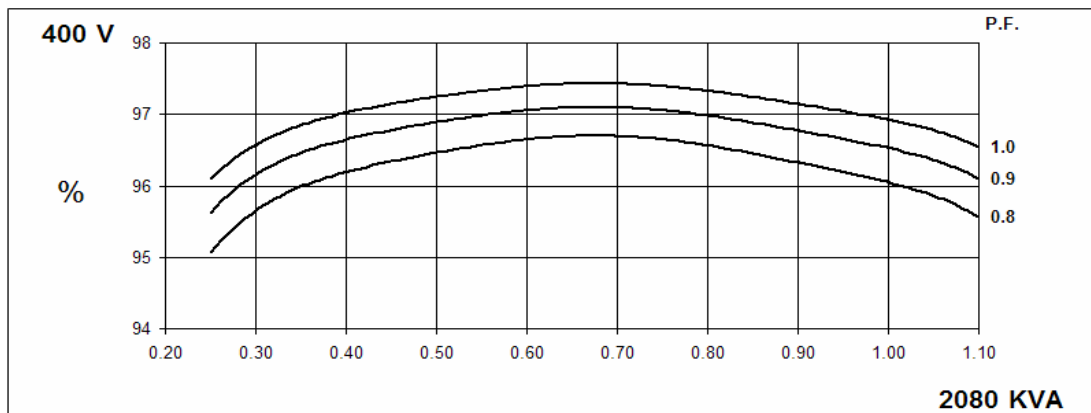
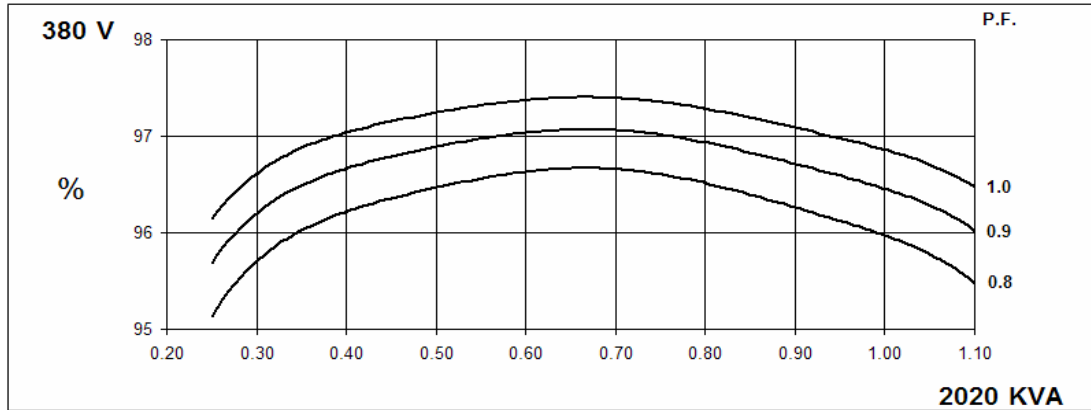

60
Hz

PI734F
Winding 312

STAMFORD

THREE PHASE EFFICIENCY CURVES

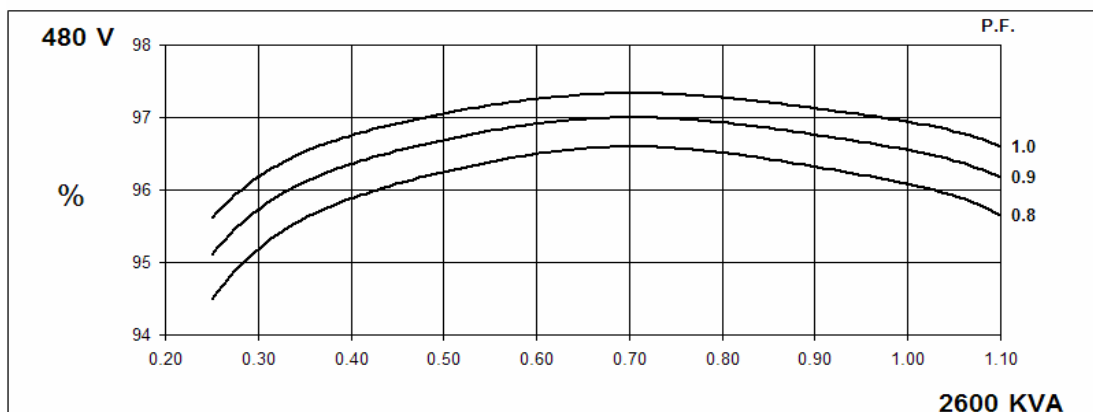
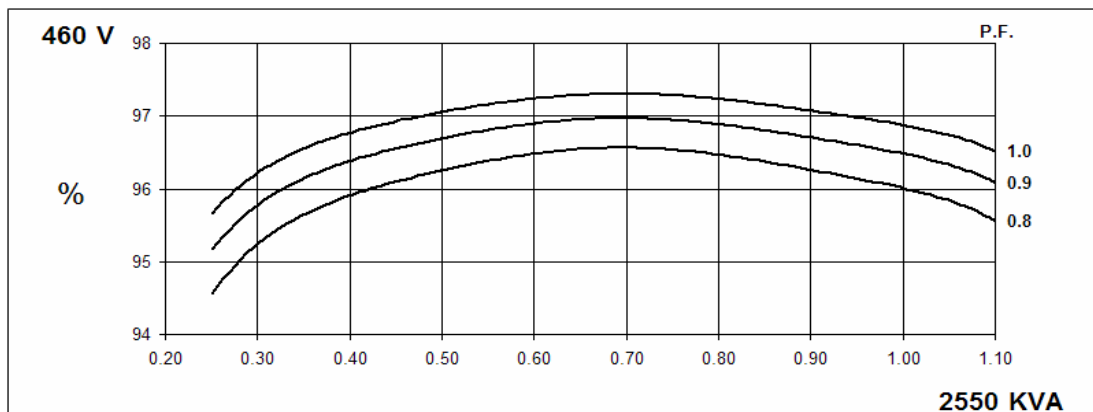
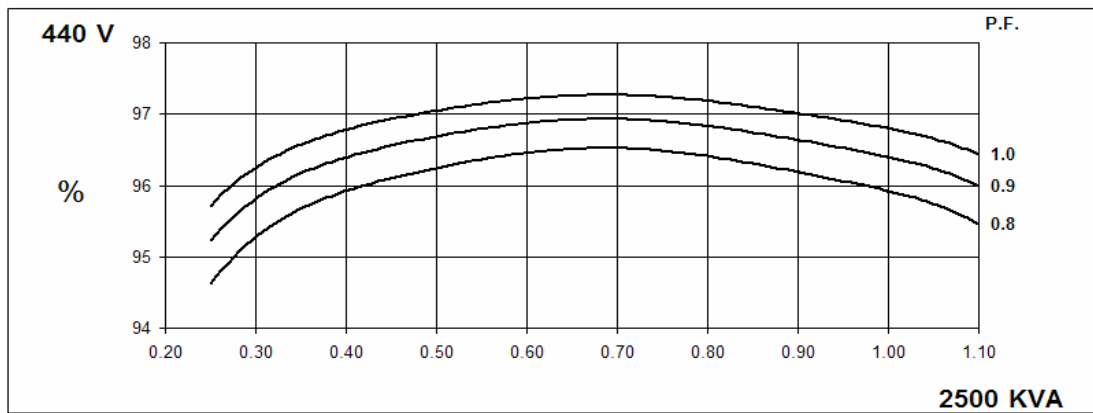
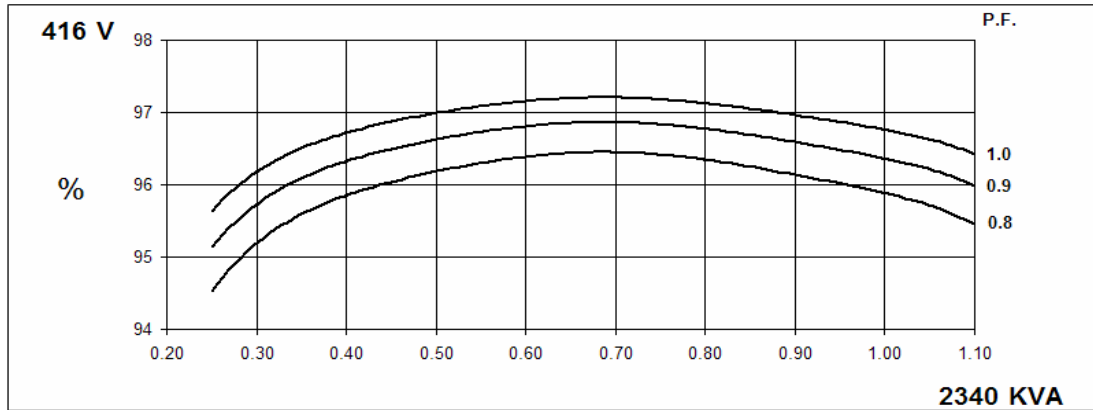

PI734F
Winding 312

STAMFORD

Locked Rotor Motor Starting Curve

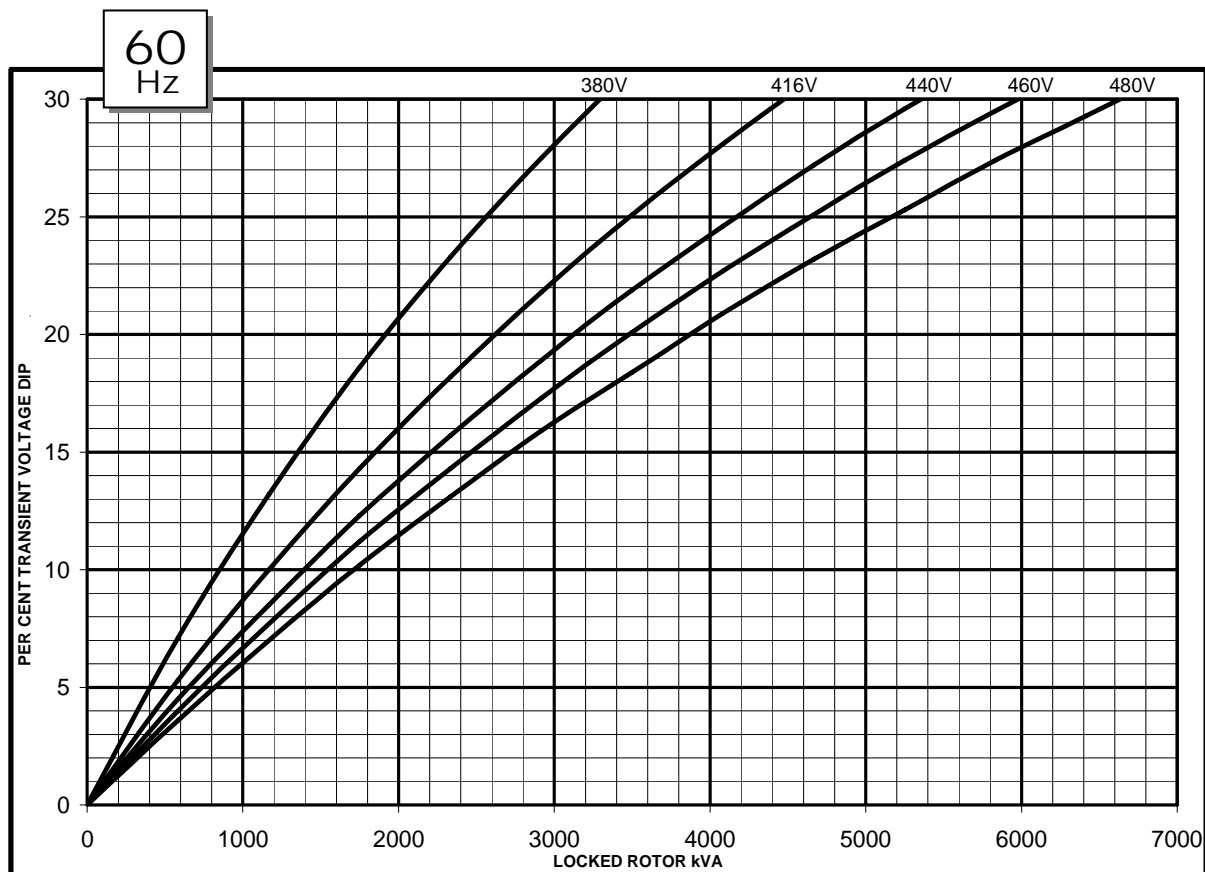
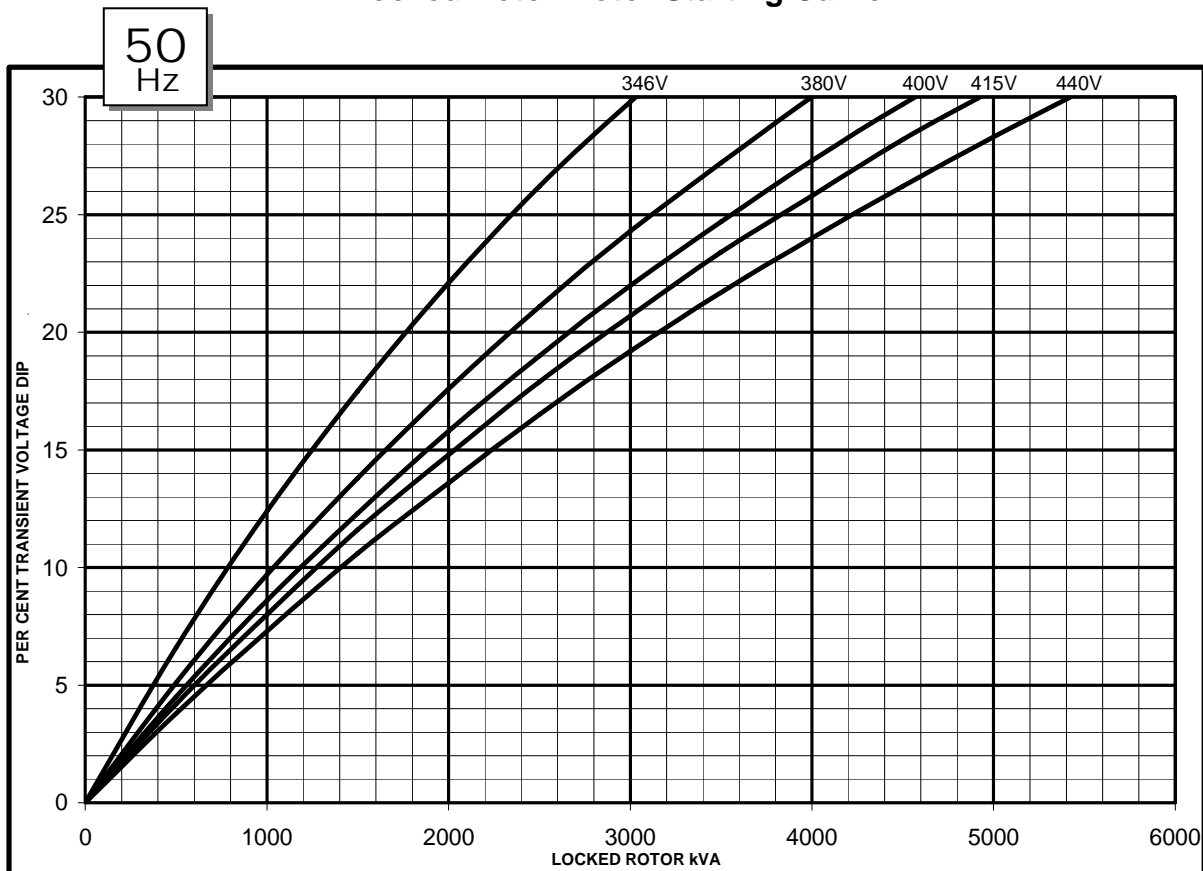

**Three-phase Short Circuit Decrement Curve. No-load Excitation at Rated Speed
Based on star (wye) connection.**

**50
Hz**

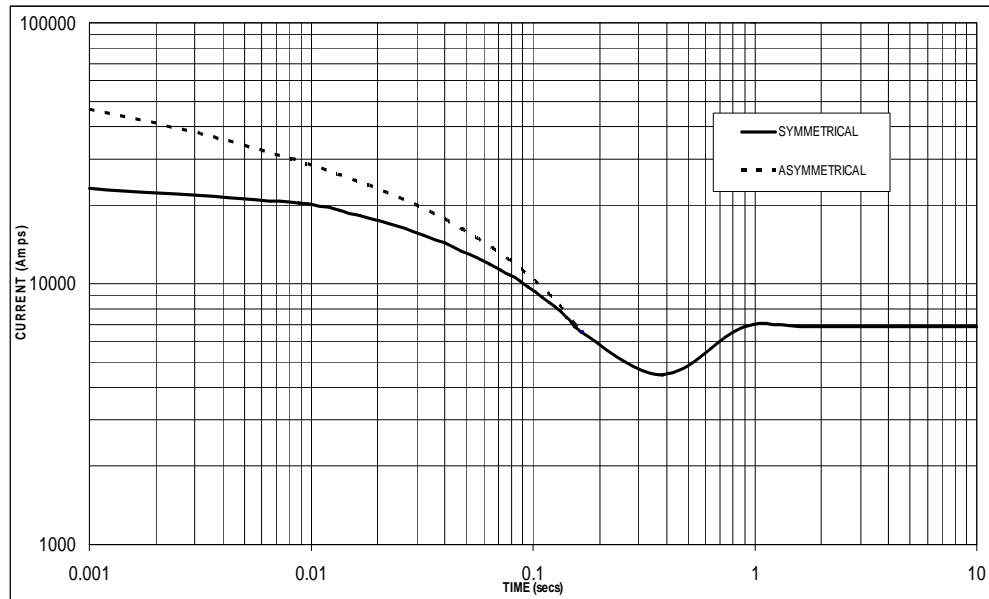

Sustained Short Circuit = 6,850 Amps

**60
Hz**

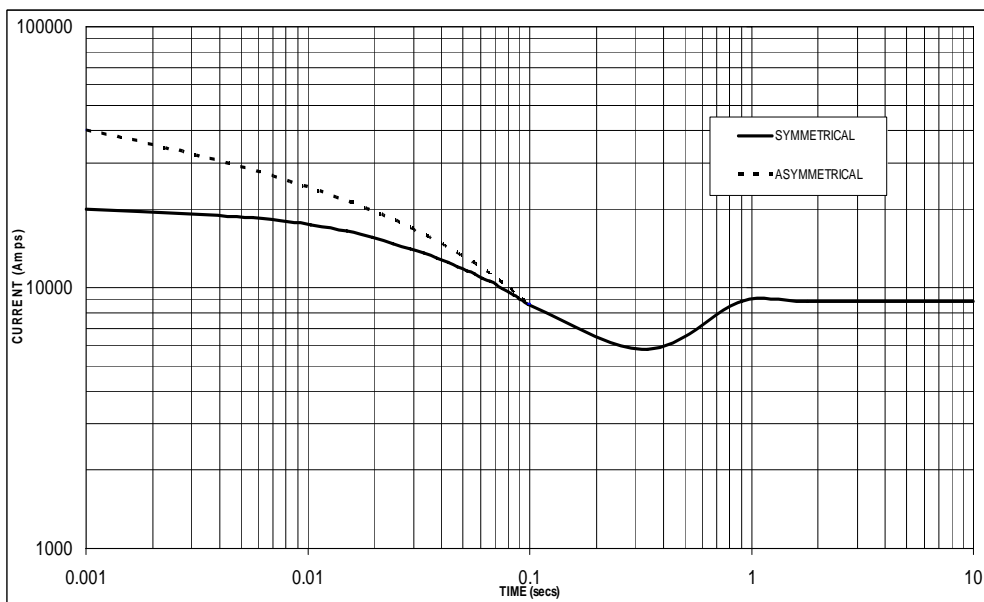

Sustained Short Circuit = 8,900 Amps

Note 1

The following multiplication factors should be used to adjust the values from curve between time 0.001 seconds and the minimum current point in respect of nominal operating voltage :

50Hz		60Hz	
Voltage	Factor	Voltage	Factor
380v	x 1.00	416v	x 1.00
400v	x 1.05	440v	x 1.06
415v	x 1.09	460v	x 1.10
440v	x 1.16	480v	x 1.15

The sustained current value is constant irrespective of voltage level

Note 2

The following multiplication factor should be used to convert the values calculated in accordance with NOTE 1 to those applicable to the various types of short circuit :

	3-phase	2-phase L-L	1-phase L-N
Instantaneous	x 1.00	x 0.87	x 1.30
Minimum	x 1.00	x 1.80	x 3.20
Sustained	x 1.00	x 1.50	x 2.50
Max. sustained duration	10 sec.	5 sec.	2 sec.

All other times are unchanged

Note 3

Curves are drawn for Star (Wye) connected machines.

PI734F
Winding 312 / 0.8 Power Factor

RATINGS

Class - Temp Rise		Cont. F - 105/40°C				Cont. H - 125/40°C				Standby - 150/40°C				Standby - 163/27°C			
50Hz	Star (V)	380	400	415	440	380	400	415	440	380	400	415	440	380	400	415	440
	kVA	1880	1935	1935	1900	2020	2080	2080	2040	2105	2170	2170	2125	2165	2230	2230	2185
	kW	1504	1548	1548	1520	1616	1664	1664	1632	1684	1736	1736	1700	1732	1784	1784	1748
	Efficiency (%)	96.1	96.2	96.3	96.4	96.0	96.0	96.1	96.3	95.9	95.9	96.0	96.2	95.8	95.9	96.0	96.2
	kW Input	1565	1609	1607	1577	1683	1733	1732	1695	1756	1810	1808	1767	1808	1860	1858	1817

60Hz	Star (V)	416	440	460	480	416	440	460	480	416	440	460	480	416	440	460	480
	kVA	2180	2325	2370	2420	2340	2500	2550	2600	2435	2600	2650	2705	2505	2675	2730	2785
	kW	1744	1860	1896	1936	1872	2000	2040	2080	1948	2080	2120	2164	2004	2140	2184	2228
	Efficiency (%)	96.0	96.1	96.1	96.2	95.9	95.9	96.0	96.1	95.8	95.8	95.9	96.0	95.7	95.8	95.9	95.9
	kW Input	1817	1935	1973	2012	1952	2086	2125	2164	2033	2171	2211	2254	2094	2234	2277	2323

DIMENSIONS

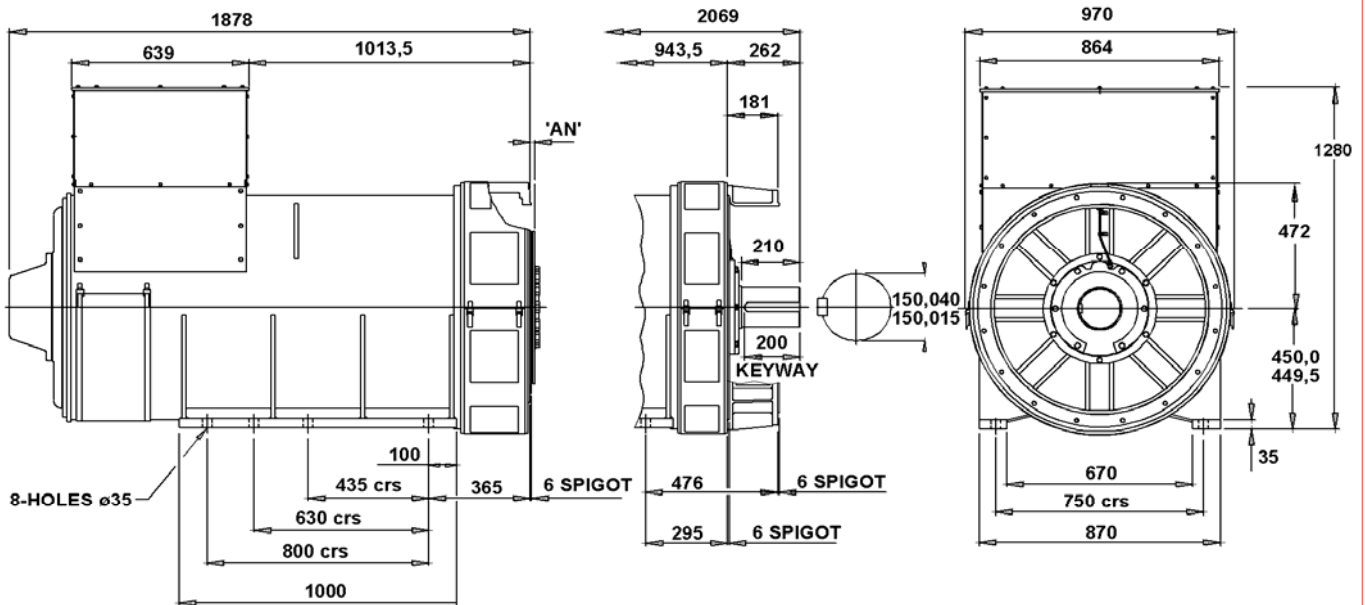

COUPLING DISC	'AN'
S.A.E No 18	15,7
S.A.E No 21	0
S.A.E No 24	0

1-BRG ADAPTORS
S.A.E No 0
S.A.E No 00

2-BRG ADAPTORS
S.A.E No 0
S.A.E No 00

QSK60-G3

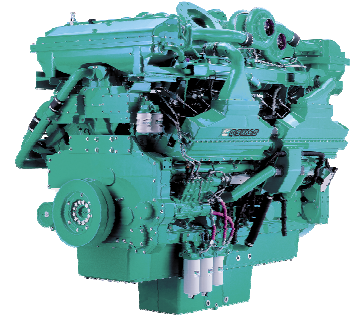

> Specification sheet

Our energy working for you.™



Description

The QSK60 is a V 16 cylinder engine with a 60 litre displacement. This Quantum series utilizes sophisticated electronics and premium engineering to provide outstanding performance levels, reliability and versatility for Standby, Prime and Continuous Power applications.



This engine has been built to comply with CE certification.



This engine has been designed in facilities certified to ISO9001 and manufactured in facilities certified to ISO9001 or ISO9002.

Features

Cummins High Pressure Injection (HPI) PT full authority electronic fuel system. The HPI PT fuel system is managed by a G-Drive Governor Control System (GCS) controller, which is provided for off-engine mounting in the genset control panel. The Quantum Control has a specific fuel system board to interface with the HPI-PT fuel system and provides an Engine Protection package giving greater customer flexibility and cost effective alternatives in the control design and the benefits of Full Authority electronic control.

CTT (Cummins Turbo Technologies) HX82/HX83 turbo-charging utilizes exhaust energy with greater efficiency for improved emissions and fuel consumption.

Low Temperature After-cooling - Two-pump Two-loop (2P2L)

Ferrous Cast Ductile Iron (FCD) Pistons - High strength design delivers superior durability.

G-Drive Integrated Design - Each component has been specifically developed and rigorously tested for G-Drive products, ensuring high performance, durability and reliability.

Service and Support - G-Drive products are backed by an uncompromising level of technical support and after sales service, delivered through a world class service network.

Coolpac Integrated Design - Products are supplied complete with cooling package and air cleaner kit for a complete power package. Each component has been specifically developed and rigorously tested for G-Drive products, ensuring high performance, durability and reliability.

1500 rpm (50 Hz Ratings)

Gross Engine Output			Net Engine Output			Typical Generator Set Output					
Standby	Prime	Base	Standby	Prime	Base	Standby (ESP)		Prime (PRP)		Base (COP)	
kWm/BHP			kWm/BHP			kWe	kVA	kWe	kVA	kWe	kVA
1790/2399	1615/2165	1305/1749	1737/2329	1580/2119	1270/1703	1600	2000	1500	1875	1219	1524



General Engine Data

Type	4 cycle, Turbocharged, After-cooled
Bore mm	159
Stroke mm	190
Displacement Litre	60.2
Cylinder Block	Cast iron, 16 cylinder
Battery Charging Alternator	55A
Starting Voltage	24V
Fuel System	Direct injection Cummins HPI
Fuel Filter	Spin on fuel filters with water separator
Lube Oil Filter Type(s)	Spin on full flow filter
Lube Oil Capacity (l)	280
Flywheel Dimensions	SAE 0

Coolpac Performance Data

Cooling System Design	2 pump - 2 loop
Coolant Ratio	50% ethylene glycol; 50% water
Coolant Capacity (l)	242.0
Limiting Ambient Temp.**	54.1
Fan Power	45.0
Cooling System Air Flow (m ³ /s)**	32.3
Air Cleaner Type	Dry replaceable element with restriction indicator

** @ 13 mm H₂O

Weight & Dimensions

Length	Width	Height	Weight (dry)
mm	mm	mm	kg
4123	2494	2995	9685

Fuel Consumption 1500 (50 Hz)

%	kWm	BHP	L/ph	US gal/ph
Standby Power				
100	1790	2399	408	107.8
Prime Power				
100	1615	2165	371	97.9
75	1211	1624	276	73.0
50	808	1082	196	51.7
25	404	541	114	30.0
Continuous Power				
100	1305	1749	299	78.8

Cummins G-Drive Engines

Asia Pacific

10 Toh Guan Road
#07-01
TT International Tradepark
Singapore 608838
Phone 65 6417 2388
Fax 65 6417 2399

Europe, CIS, Middle East and Africa

Manston Park Columbus Ave
Manston Ramsgate
Kent CT12 5BF, UK
Phone 44 1843 255000
Fax 44 1843 255902

Latin America

Rua Jati, 310, Cumbica
Guarulhos, SP 07180-900
Brazil
Phone 55 11 2186 4552
Fax 55 11 2186 4729

Mexico

Cummins S. de R.L. de C.V.
Eje 122 No. 200 Zona Industrial
San Luis Potosi, S.L.P. 78090
Mexico
Phone 52 444 870 6700
Fax 52 444 870 6811

North America

1400 73rd Avenue N.E.
Minneapolis, MN 55432
USA
Phone 1 763 574 5000
USA Toll-free 1 877 769 7669
Fax 1 763 574 5298

Ratings Definitions

Emergency Standby Power (ESP):

Applicable for supplying power to varying electrical load for the duration of power interruption of a reliable utility source. Emergency Standby Power (ESP) is in accordance with ISO 3046, AS 2789, DIN 6271 and BS 5514.

Limited-Time Running Power (LTP):

Applicable for supplying power to a constant electrical load for limited hours. Limited-Time Running Power (LTP) is in accordance with ISO 8528.

Prime Power (PRP):

Applicable for supplying power to varying electrical load for unlimited hours. Prime Power (PRP) is in accordance with ISO 8528. Ten percent overload capability is available in accordance with ISO 3046, AS 2789, DIN 6271 and BS 5514.

Base Load (Continuous) Power (COP):

Applicable for supplying power continuously to a constant electrical load for unlimited hours. Continuous Power (COP) in accordance with ISO 8528, ISO 3046, AS 2789, DIN6271 and BS 5514.



PI734E - Technical Data Sheet

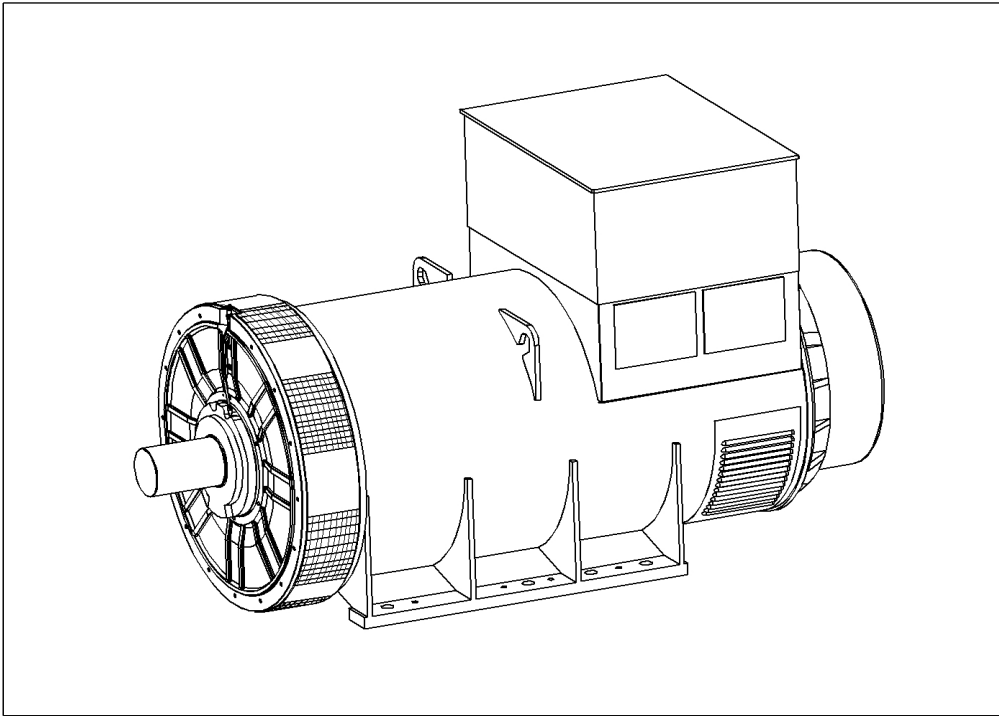

PI734E

SPECIFICATIONS & OPTIONS



STANDARDS

Newage Stamford industrial generators meet the requirements of BS EN 60034 and the relevant sections of other national and international standards such as BS5000, VDE 0530, NEMA MG1-32, IEC60034, CSA C22.2-100, AS1359.

Other standards and certifications can be considered on request.

DESCRIPTION

The STAMFORD PI range of synchronous ac generators are brushless with a rotating field. They are separately excited by the STAMFORD Permanent Magnet Generator (PMG). This is a shaft mounted, high frequency, pilot exciter which provides a constant supply of clean power via the Automatic Voltage Regulator (AVR) to the main exciter. The main exciter output is fed to the main rotor, through a full wave bridge rectifier, protected by surge suppression.

VOLTAGE REGULATORS

The PI range generators, complete with a PMG, are available with one of two AVRs. Each AVR has soft start voltage build up and built in protection against sustained over-excitation, which will de-excite the generator after a minimum of 8 seconds.

Underspeed protection (UFRO) is also provided on both AVRs. The UFRO will reduce the generator output voltage proportional to the speed of the generator below a pre-settable level.

The **MX341 AVR** is two phase sensed with a voltage regulation of $\pm 1\%$. (see the note on regulation).

The **MX321 AVR** is 3 phase rms sensed with a voltage regulation of 0.5% rms (see the note on regulation). The UFRO circuit has adjustable slope and dwell for controlled recovery from step loads. An over voltage protection circuit will shutdown the output device of the AVR, it can also trip an optional excitation circuit breaker if required. As an option, short circuit current limiting is available with the addition of current transformers.

Both the MX341 and the MX321 need a generator mounted current transformer to provide quadrature droop characteristics for load sharing during parallel operation. Provision is also made for the connection of the STAMFORD power factor controller, for embedded applications, and a remote voltage trimmer.

WINDINGS & ELECTRICAL PERFORMANCE

All generator stators are wound to 2/3 pitch. This eliminates triplen (3rd, 9th, 15th ...) harmonics on the voltage waveform and is found to be the optimum design for trouble-free supply of non-linear loads. The 2/3 pitch design avoids excessive neutral currents sometimes seen with higher winding pitches. A fully connected damper winding reduces oscillations during paralleling. This winding, with the 2/3 pitch and carefully selected pole and tooth designs, ensures very low levels of voltage waveform distortion.

TERMINALS & TERMINAL BOX

Standard generators feature a main stator with 6 ends brought out to the terminals, which are mounted on the frame at the non-drive end of the generator. A sheet steel terminal box contains the AVR and provides ample space for the customers' wiring and gland arrangements. It has removable panels for easy access.

SHAFT & KEYS

All generator rotors are dynamically balanced to better than BS6861:Part 1 Grade 2.5 for minimum vibration in operation. Two bearing generators are balanced with a half key.

INSULATION/IMPREGNATION

The insulation system is class 'H', and meets the requirements of UL1446.

All wound components are impregnated with materials and processes designed specifically to provide the high build required for static windings and the high mechanical strength required for rotating components.

QUALITY ASSURANCE

Generators are manufactured using production procedures having a quality assurance level to BS EN ISO 9001.

NOTE ON REGULATION

The stated voltage regulation may not be maintained in the presence of certain radio transmitted signals. Any change in performance will fall within the limits of Criteria 'B' of EN 61000-6-2:2001. At no time will the steady-state voltage regulation exceed 2%.

Note: Continuous development of our products entitles us to change specification details without notice, therefore they must not be regarded as binding.

Front cover drawing is typical of the product range.

PI734E
WINDING 312

CONTROL SYSTEM	SEPARATELY EXCITED BY P.M.G.		
A.V.R.	MX341	MX321	
VOLTAGE REGULATION	± 1 %	± 0.5 %	With 4% ENGINE GOVERNING
SUSTAINED SHORT CIRCUIT	REFER TO SHORT CIRCUIT DECREMENT CURVES (page 7)		

INSULATION SYSTEM	CLASS H
PROTECTION	IP23
RATED POWER FACTOR	0.8
STATOR WINDING	DOUBLE LAYER LAP
WINDING PITCH	TWO THIRDS
WINDING LEADS	6
MAIN STATOR RESISTANCE	0.00093 Ohms PER PHASE AT 22°C STAR CONNECTED
MAIN ROTOR RESISTANCE	2.17 Ohms at 22°C
EXCITER STATOR RESISTANCE	17.5 Ohms at 22°C
EXCITER ROTOR RESISTANCE	0.048 Ohms PER PHASE AT 22°C
R.F.I. SUPPRESSION	BS EN 61000-6-2 & BS EN 61000-6-4, VDE 0875G, VDE 0875N. refer to factory for others
WAVEFORM DISTORTION	NO LOAD < 1.5% NON-DISTORTING BALANCED LINEAR LOAD < 5.0%
MAXIMUM OVERSPEED	2250 Rev/Min
BEARING DRIVE END	BALL. 6228 C3
BEARING NON-DRIVE END	BALL. 6319 C3

	1 BEARING	2 BEARING
WEIGHT COMP. GENERATOR	3556 kg	3506 kg
WEIGHT WOUND STATOR	1747 kg	1747 kg
WEIGHT WOUND ROTOR	1494 kg	1432 kg
WR ² INERTIA	45.49 kgm ²	44.4891 kgm ²
SHIPPING WEIGHTS in a crate	3629kg	3575kg
PACKING CRATE SIZE	216 x 105 x 154(cm)	216 x 105 x 154(cm)

	50 Hz				60 Hz			
TELEPHONE INTERFERENCE	THF<2%				TIF<50			
COOLING AIR	2.69 m ³ /sec 5700 cfm				3.45 m ³ /sec 7300 cfm			
VOLTAGE STAR	380/220	400/231	415/240	440/254	416/240	440/254	460/266	480/277
KVA BASE RATING FOR REACTANCE VALUES	1845	1900	1900	1865	2070	2210	2255	2300
X _d DIR. AXIS SYNCHRONOUS	3.18	2.96	2.75	2.40	3.84	3.67	3.42	3.21
X' _d DIR. AXIS TRANSIENT	0.19	0.18	0.17	0.15	0.23	0.22	0.21	0.19
X'' _d DIR. AXIS SUBTRANSIENT	0.14	0.13	0.12	0.11	0.17	0.16	0.15	0.14
X _q QUAD. AXIS REACTANCE	2.04	1.90	1.76	1.54	2.47	2.36	2.20	2.06
X'' _q QUAD. AXIS SUBTRANSIENT	0.29	0.27	0.25	0.22	0.35	0.33	0.31	0.29
X _L LEAKAGE REACTANCE	0.04	0.03	0.03	0.03	0.04	0.04	0.04	0.04
X ₂ NEGATIVE SEQUENCE	0.20	0.19	0.17	0.15	0.24	0.23	0.22	0.20
X ₀ ZERO SEQUENCE	0.02	0.02	0.02	0.02	0.03	0.03	0.03	0.03

REACTANCES ARE SATURATED

VALUES ARE PER UNIT AT RATING AND VOLTAGE INDICATED

T' _d TRANSIENT TIME CONST.	0.149s
T'' _d SUB-TRANSTIME CONST.	0.02s
T' _{do} O.C. FIELD TIME CONST.	2.46s
T _a ARMATURE TIME CONST.	0.02s
SHORT CIRCUIT RATIO	1/X _d

**50
Hz**

PI734E
Winding 312



THREE PHASE EFFICIENCY CURVES

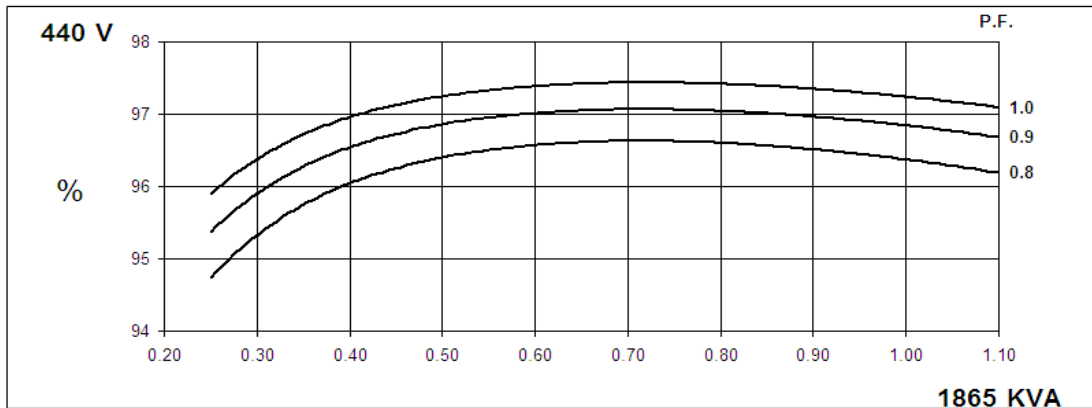
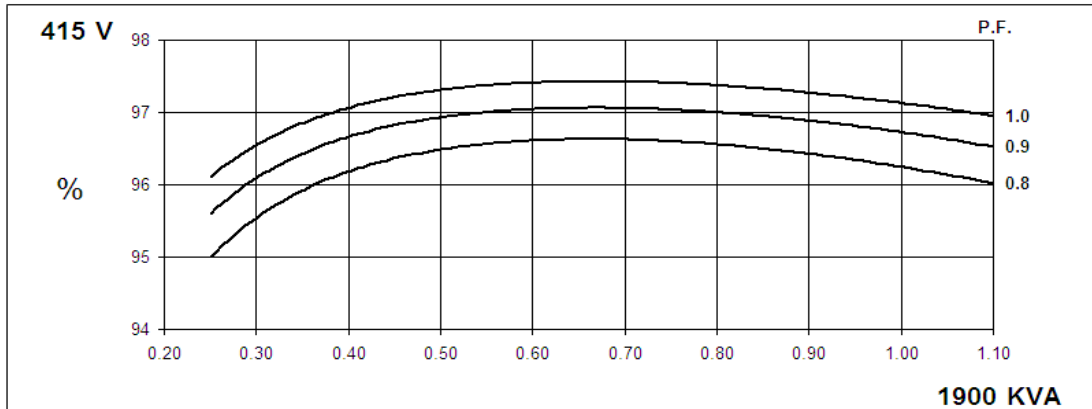
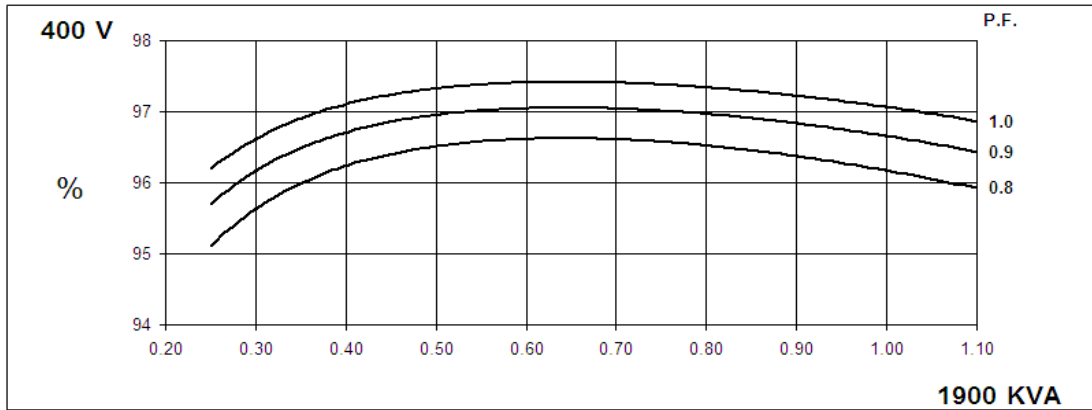
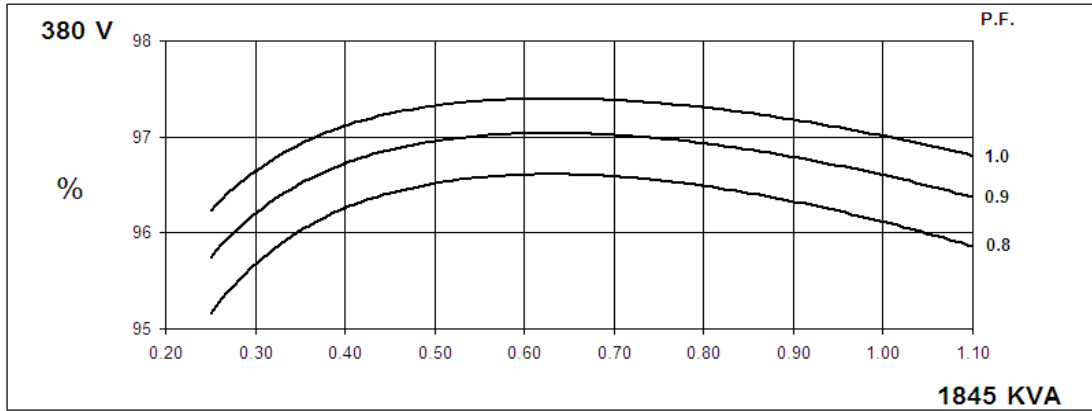

THREE PHASE EFFICIENCY CURVES

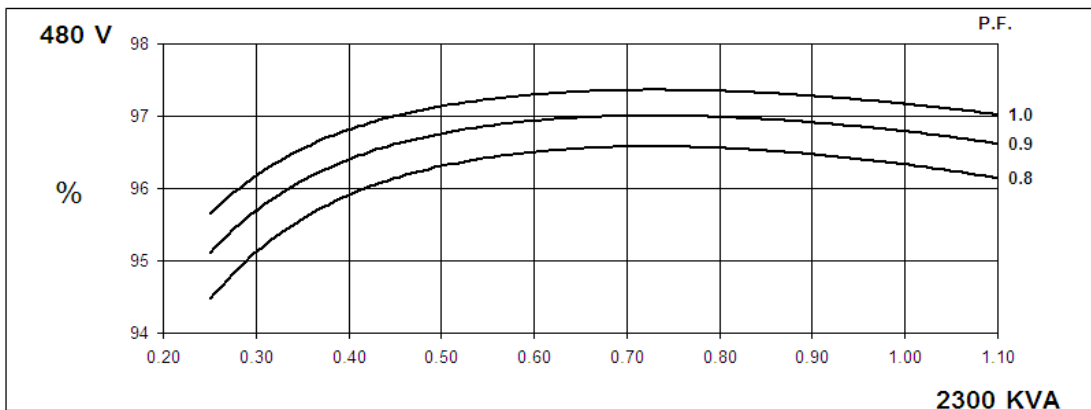
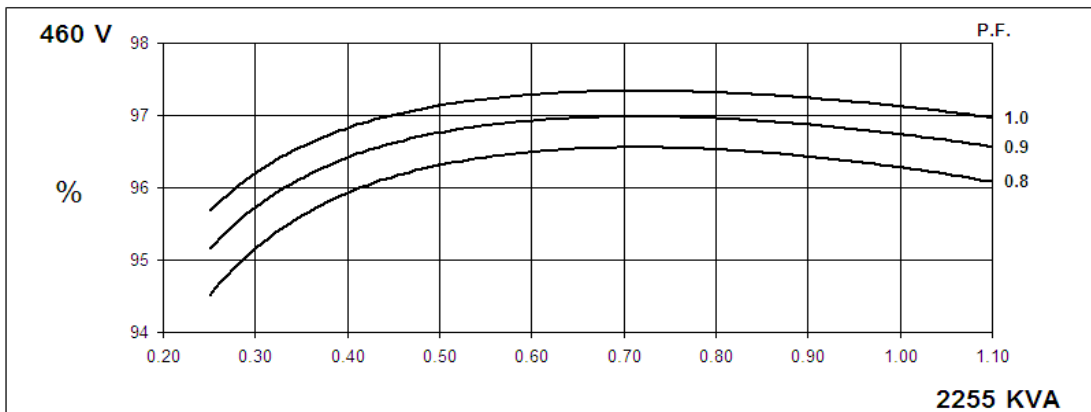
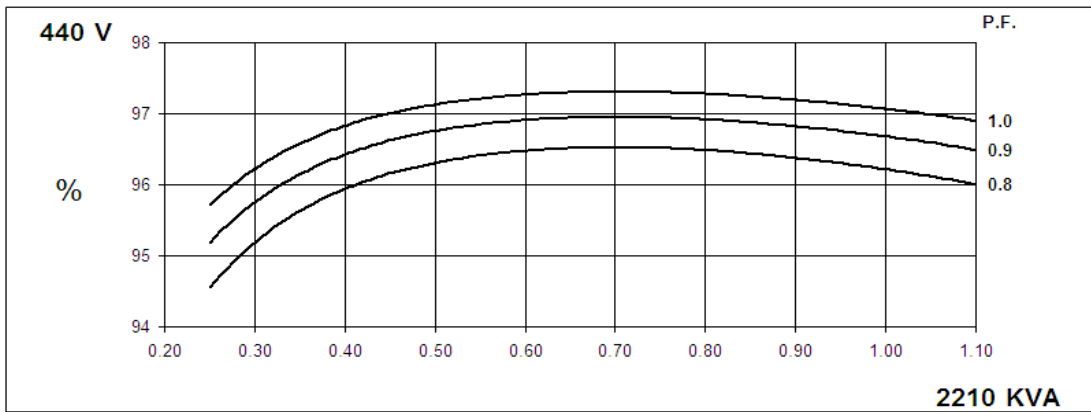
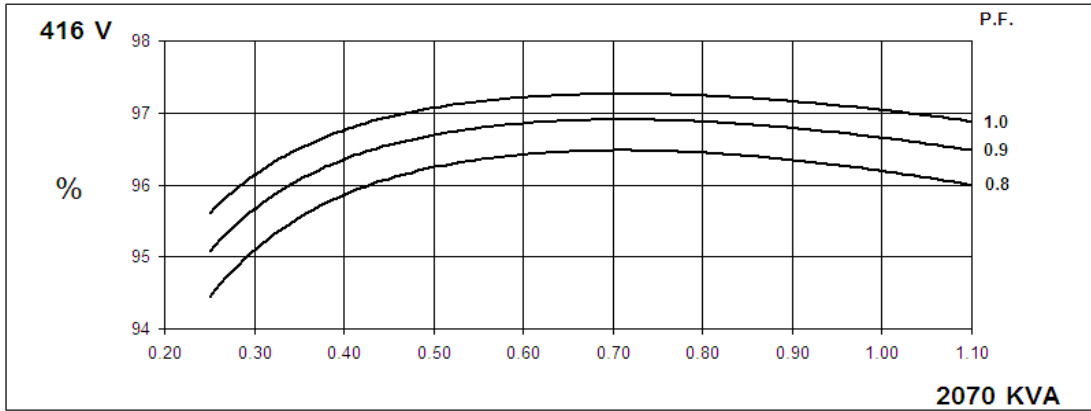

PI734E

Winding 312



Locked Rotor Motor Starting Curve

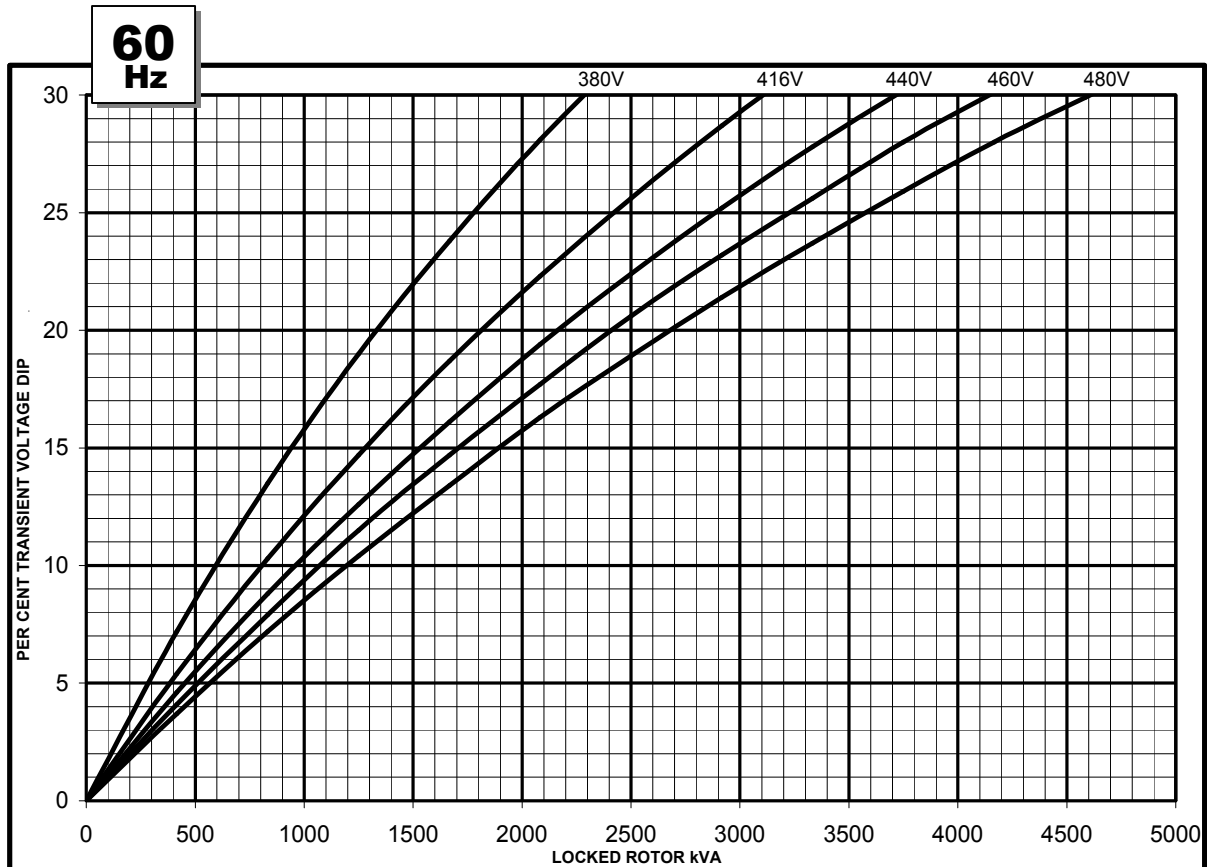
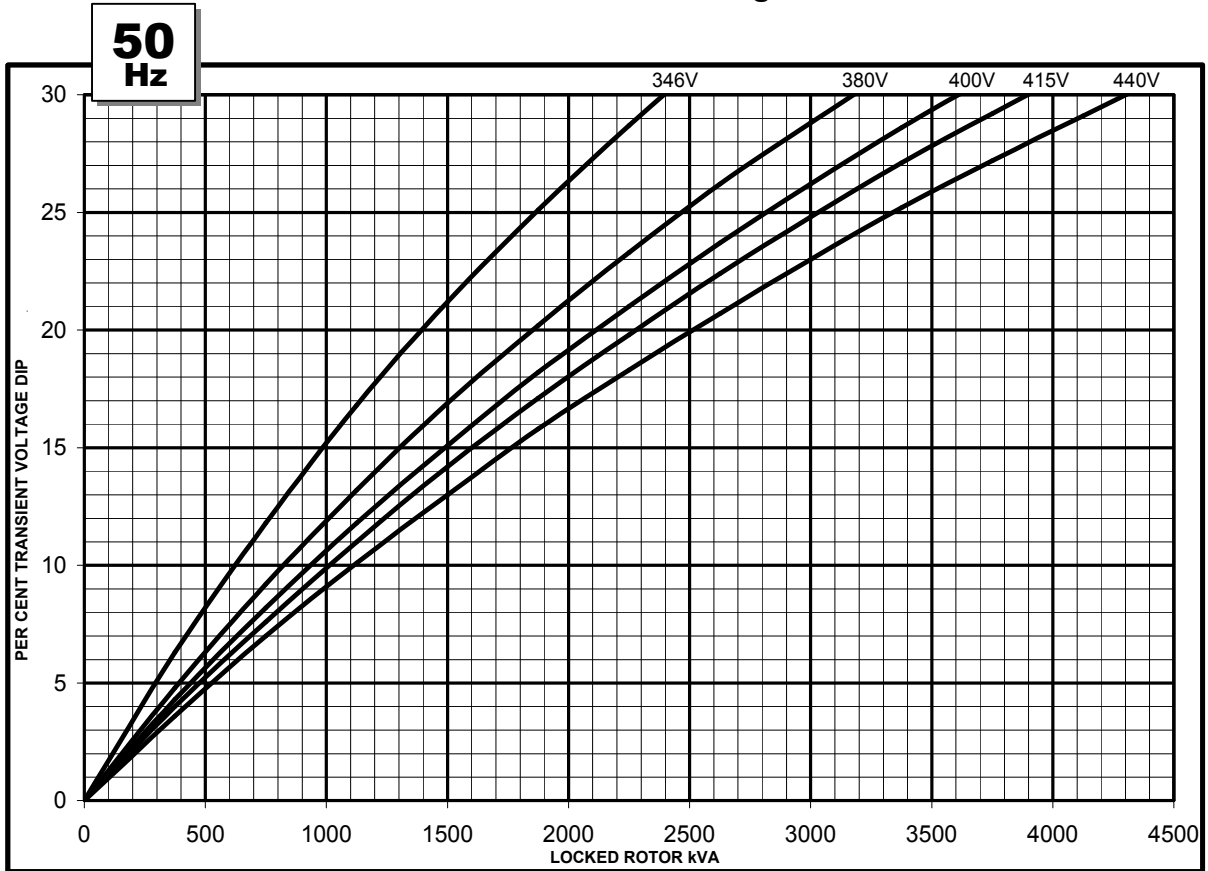

**Three-phase Short Circuit Decrement Curve. No-load Excitation at Rated Speed
Based on star (wye) connection.**

**50
Hz**

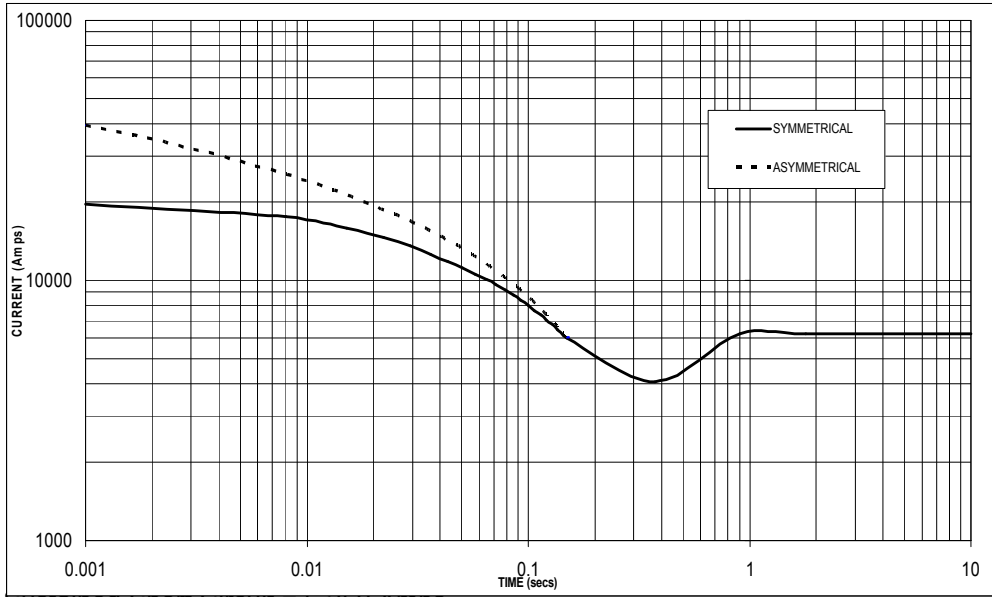

**60
Hz**

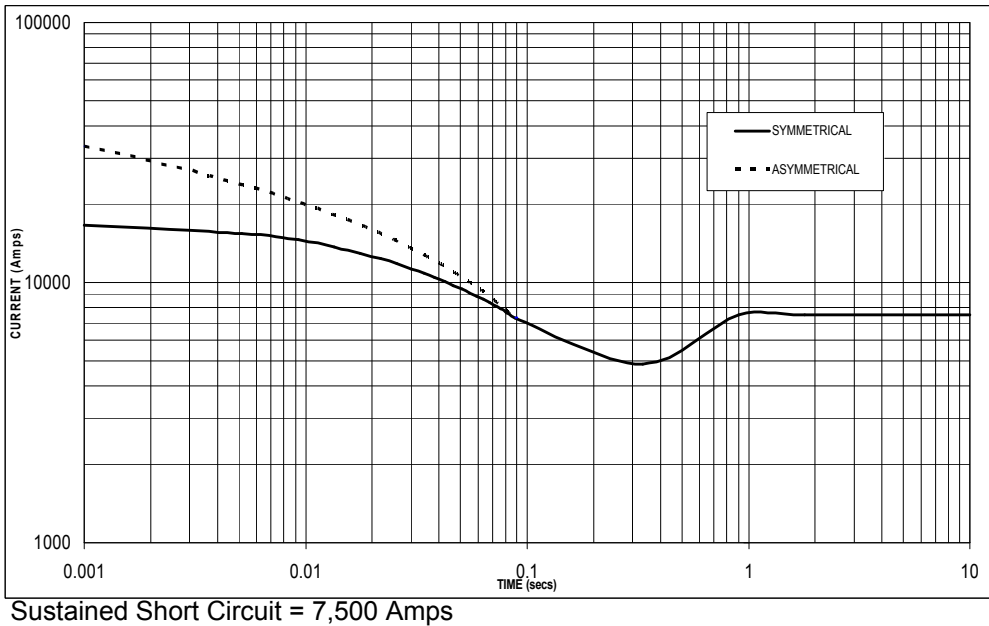

Note 1

The following multiplication factors should be used to adjust the values from curve between time 0.001 seconds and the minimum current point in respect of nominal operating voltage :

50Hz		60Hz	
Voltage	Factor	Voltage	Factor
380v	x 1.00	416v	x 1.00
400v	x 1.05	440v	x 1.06
415v	x 1.09	460v	x 1.10
440v	x 1.16	480v	x 1.15

The sustained current value is constant irrespective of voltage level

Note 2

The following multiplication factor should be used to convert the values calculated in accordance with NOTE 1 to those applicable to the various types of short circuit :

	3-phase	2-phase L-L	1-phase L-N
Instantaneous	x 1.00	x 0.87	x 1.30
Minimum	x 1.00	x 1.80	x 3.20
Sustained	x 1.00	x 1.50	x 2.50
Max. sustained duration	10 sec.	5 sec.	2 sec.

All other times are unchanged

Note 3

Curves are drawn for Star (Wye) connected machines.

PI734E

Winding 312 / 0.8 Power Factor



RATINGS

Class - Temp Rise		Cont. F - 105/40°C				Cont. H - 125/40°C				Standby - 150/40°C				Standby - 163/27°C			
50Hz	Star (V)	380	400	415	440	380	400	415	440	380	400	415	440	380	400	415	440
	kVA	1715	1770	1770	1735	1845	1900	1900	1865	1920	1980	1980	1940	1975	2035	2035	1995
	kW	1372	1416	1416	1388	1476	1520	1520	1492	1536	1584	1584	1552	1580	1628	1628	1596
	Efficiency (%)	96.3	96.3	96.4	96.5	96.1	96.2	96.2	96.4	96.0	96.1	96.2	96.3	95.9	96.0	96.1	96.2
	kW Input	1425	1470	1469	1438	1536	1580	1580	1548	1600	1648	1647	1612	1648	1696	1694	1659

60Hz	Star (V)	416	440	460	480	416	440	460	480	416	440	460	480	416	440	460	480
	kVA	1935	2055	2100	2140	2070	2210	2255	2300	2155	2300	2345	2395	2215	2365	2415	2465
	kW	1548	1644	1680	1712	1656	1768	1804	1840	1724	1840	1876	1916	1772	1892	1932	1972
	Efficiency (%)	96.3	96.3	96.4	96.4	96.2	96.2	96.3	96.3	96.1	96.1	96.2	96.3	96.1	96.1	96.1	96.2
	kW Input	1607	1707	1743	1776	1721	1838	1873	1911	1794	1915	1950	1990	1844	1969	2010	2050

DIMENSIONS

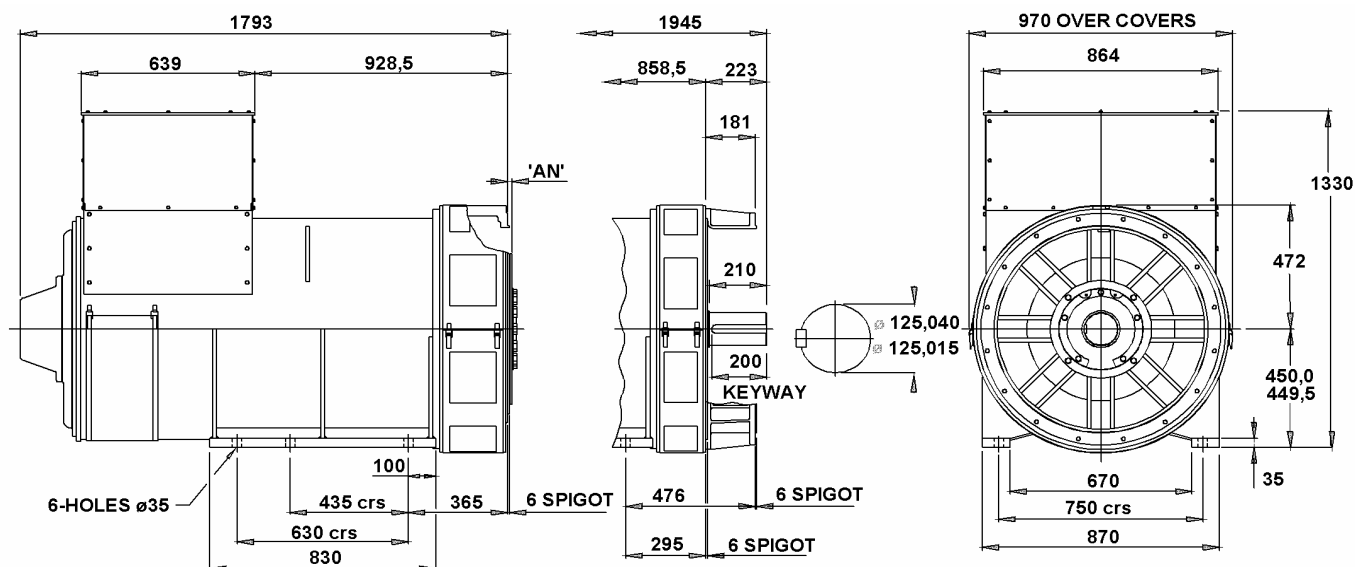

COUPLING DISC	'AN'
S.A.E No 18	15,7
S.A.E No 21	0
S.A.E No 24	0

1-BRG ADAPTORS
S.A.E No 0
S.A.E No 00

2-BRG ADAPTORS
S.A.E No 0
S.A.E No 00



Barnack Road • Stamford • Lincolnshire • PE9 2NB
Tel: 00 44 (0)1780 484000 • Fax: 00 44 (0)1780 484100

QSK23-G3



> Specification sheet

Our energy working for you.™



Description

The QSK23 is an in-line 6 cylinder engine with a 23 litre displacement. This Quantum series utilizes sophisticated electronics and premium engineering to provide outstanding performance levels, reliability and versatility for Standby, Prime and Continuous Power applications.



This engine has been built to comply with CE certification.



This engine has been designed in facilities certified to ISO9001 and manufactured in facilities certified to ISO9001 or ISO9002.

Features

The QSK23 uses the Cummins High Pressure Injection (HPI) PT full authority electronic fuel system. The HPI PT fuel system is managed by a G-Drive Governor Control System (GCS) controller, which is provided for off-engine mounting in the genset control panel. The Quantum Control has a specific fuel system board to interface with the HPI-PT fuel system and provides an Engine Protection package giving greater customer flexibility and cost effective alternatives in the control design and the benefits of Full Authority electronic control.

CTT (Cummins Turbo Technologies) HX82 turbo-charging utilizes exhaust energy with greater efficiency for improved emissions and fuel consumption.

Charge Air Cooling - QSK23 engine requires the use of an Air-to-Air heat exchanger or Charge-Air-Cooler (CAC) to reduce intake manifold temperature and to meet the lower emissions requirements.

CoolPac Integrated Design - Products are supplied complete with cooling package and air cleaner kit for a complete power package. Each component has been specifically developed and rigorously tested for G-Drive products, ensuring high performance, durability and reliability.

Service and Support - G-Drive products are backed by an uncompromising level of technical support and after sales service, delivered through a world class service network.

1500 rpm (50 Hz Ratings)

Gross Engine Output			Net Engine Output			Typical Generator Set Output					
Standby	Prime	Base	Standby	Prime	Base	Standby (ESP)		Prime (PRP)		Base (COP)	
kWm/BHP			kWm/BHP			kWe	kVA	kWe	kVA	kWe	kVA
768/1030	701/940	537/720	739/991	682/915	517/693	720	900	648	810	491	614

1800 rpm (60 Hz Ratings)

Gross Engine Output			Net Engine Output			Typical Generator Set Output					
Standby	Prime	Base	Standby	Prime	Base	Standby (ESP)		Prime (PRP)		Base (COP)	
kWm/BHP			kWm/BHP			kWe	kVA	kWe	kVA	kWe	kVA
895/1200	809/1085	652/875	857/1149	776/1041	621/833	800	1000	727	909	583	729



General Engine Data

Type	4 cycle, Turbocharged		
Bore mm	170		
Stroke mm	170		
Displacement Litre	23.1		
Cylinder Block	Cast iron, 6 cylinder		
Battery Charging Alternator	35A		
Starting Voltage	24V		
Fuel System	Direct injection Cummins HPI		
Fuel Filter	Spin on fuel filters with water separator		
Lube Oil Filter Type(s)	Spin on full flow filter		
Lube Oil Capacity (l)	103		
Flywheel Dimensions	SAE 0		

Coolpac Performance Data

Cooling System Design	Air-air charge cooled		
Coolant Ratio	50% ethylene glycol; 50% water		
Total Coolant Capacity (l)	110		
Limiting Ambient Temp (°C)**	50.9 (50Hz)	55.0 (60Hz)	
Fan Power (kWm)	14.4 (50Hz)	24.2 (60Hz)	
Cooling System Air Flow (m ³ /s)**	13.5 (50Hz)	16.6 (60Hz)	
Air Cleaner Type	Dry replaceable element with restriction indicator		

** @ 13 mm H²O

Ratings Definitions

Emergency Standby Power (ESP):

Applicable for supplying power to varying electrical load for the duration of power interruption of a reliable utility source. Emergency Standby Power (ESP) is in accordance with ISO 8528. Fuel Stop power in accordance with ISO 3046, AS 2789, DIN 6271 and BS 5514.

Limited-Time Running Power (LTP):

Applicable for supplying power to a constant electrical load for limited hours. Limited-Time Running Power (LTP) is in accordance with ISO 8528.

Prime Power (PRP):

Applicable for supplying power to varying electrical load for unlimited hours. Prime Power (PRP) is in accordance with ISO 8528. Ten percent overload capability is available in accordance with ISO 3046, AS 2789, DIN 6271 and BS 5514.

Base Load (Continuous) Power (COP):

Applicable for supplying power continuously to a constant electrical load for unlimited hours. Continuous Power (COP) in accordance with ISO 8528, ISO 3046, AS 2789, DIN6271 and BS 5514.

Weight & Dimensions

Length	Width	Height	Weight (dry)
mm	mm	mm	kg
2976	1656	1964	3245

Fuel Consumption 1500 (50 Hz)

%	kWm	BHP	L/ph	US gal/ph
Standby Power				
100	768	1030	178	46.9
Prime Power				
100	701	940	161	42.5
75	526	705	121	32.0
50	351	470	85	22.4
25	175	235	46	12.2
Continuous Power				
100	537	720	125	33.1

Fuel Consumption 1800 (60 Hz)

%	kWm	BHP	L/ph	US gal/ph
Standby Power				
100	895	1200	212	56.1
Prime Power				
100	809	1085	189	49.8
75	607	814	139	36.7
50	405	543	97	25.7
25	202	271	56	14.7
Continuous Power				
100	653	875	149	39.4

Cummins G-Drive Engines

Asia Pacific

10 Toh Guan Road
#07-01
TT International Tradepark
Singapore 608838
Phone 65 6417 2388
Fax 65 6417 2399

Europe, CIS, Middle East and Africa

Manston Park Columbus Ave
Manston Ramsgate
Kent CT12 5BF. UK
Phone 44 1843 255000
Fax 44 1843 255902

Latin America

Rua Jati, 310, Cumbica
Guarulhos, SP 07180-900
Brazil
Phone 55 11 2186 4552
Fax 55 11 2186 4729

Mexico

Cummins S. de R.L. de C.V.
Eje 122 No. 200 Zona Industrial
San Luis Potosí, S.L.P. 78090
Mexico
Phone 52 444 870 6700
Fax 52 444 870 6811

North America

1400 73rd Avenue N.E.
Minneapolis, MN 55432
USA
Phone 1 763 574 5000
USA Toll-free 1 877 769 7669
Fax 1 763 574 5298



STAMFORD[®]

HCI634G - Technical Data Sheet

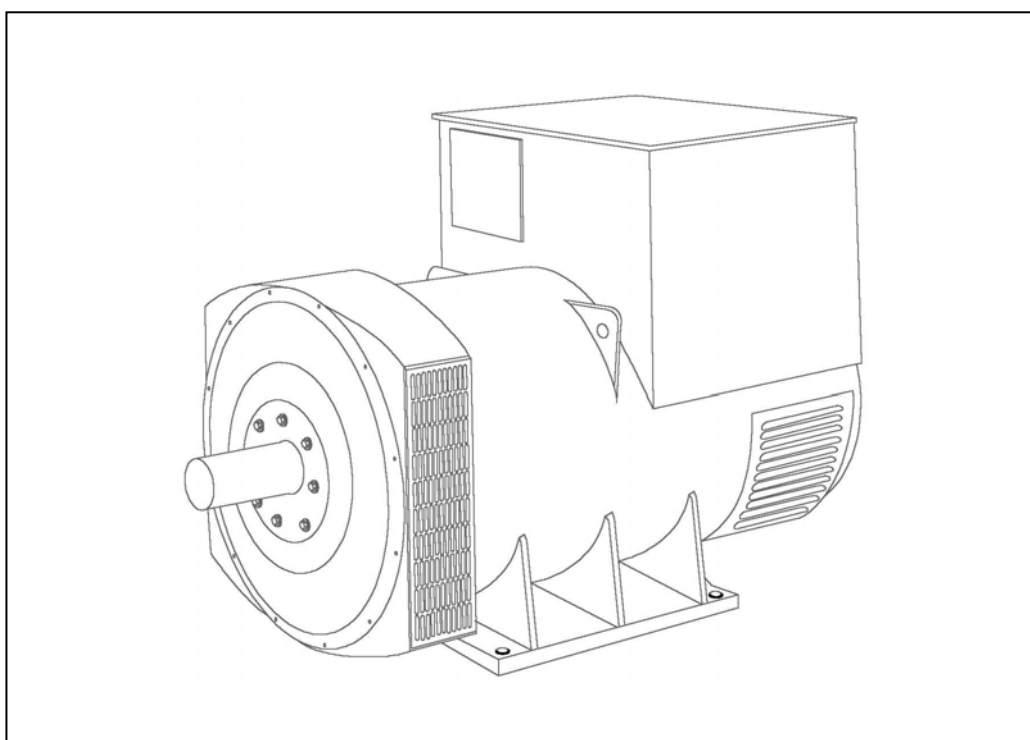

HCI634G

SPECIFICATIONS & OPTIONS

STAMFORD

STANDARDS

Newage Stamford industrial generators meet the requirements of BS EN 60034 and the relevant section of other international standards such as BS5000, VDE 0530, NEMA MG1-32, IEC34, CSA C22.2-100, AS1359.

Other standards and certifications can be considered on request.

VOLTAGE REGULATORS

MX321 AVR - STANDARD

This sophisticated Automatic Voltage Regulator (AVR) is incorporated into the Stamford Permanent Magnet Generator (PMG) system and is fitted as standard to generators of this type.

The PMG provides power via the AVR to the main exciter, giving a source of constant excitation power independent of generator output. The main exciter output is then fed to the main rotor, through a full wave bridge, protected by a surge suppressor. The AVR has in-built protection against sustained over-excitation, caused by internal or external faults. This de-excites the machine after a minimum of 5 seconds.

Over voltage protection is built-in and short circuit current level adjustments is an optional facility.

WINDINGS & ELECTRICAL PERFORMANCE

All generator stators are wound to 2/3 pitch. This eliminates triplen (3rd, 9th, 15th ...) harmonics on the voltage waveform and is found to be the optimum design for trouble-free supply of non-linear loads. The 2/3 pitch design avoids excessive neutral currents sometimes seen with higher winding pitches, when in parallel with the mains. A fully connected damper winding reduces oscillations during paralleling. This winding, with the 2/3 pitch and carefully selected pole and tooth designs, ensures very low waveform distortion.

TERMINALS & TERMINAL BOX

Standard generators feature a main stator with 6 ends brought out to the terminals, which are mounted on the frame at the non-drive end of the generator. A sheet steel terminal box contains the AVR and provides ample space for the customers' wiring and gland arrangements. It has removable panels for easy access.

SHAFT & KEYS

All generator rotors are dynamically balanced to better than BS6861:Part 1 Grade 2.5 for minimum vibration in operation. Two bearing generators are balanced with a half key.

INSULATION/IMPREGNATION

The insulation system is class 'H'.

All wound components are impregnated with materials and processes designed specifically to provide the high build required for static windings and the high mechanical strength required for rotating components.

QUALITY ASSURANCE

Generators are manufactured using production procedures having a quality assurance level to BS EN ISO 9001.

The stated voltage regulation may not be maintained in the presence of certain radio transmitted signals. Any change in performance will fall within the limits of Criteria 'B' of EN 61000-6-2:2001. At no time will the steady-state voltage regulation exceed 2%.

NB Continuous development of our products entitles us to change specification details without notice, therefore they must not be regarded as binding.

Front cover drawing typical of product range.

HCI634G WINDING 312

STAMFORD

CONTROL SYSTEM	SEPARATELY EXCITED BY P.M.G.		
A.V.R.	MX321		
VOLTAGE REGULATION	± 0.5 %	With 4% ENGINE GOVERNING	
SUSTAINED SHORT CIRCUIT	REFER TO SHORT CIRCUIT DECREMENT CURVES (page 7)		

INSULATION SYSTEM	CLASS H							
PROTECTION	IP23							
RATED POWER FACTOR	0.8							
STATOR WINDING	DOUBLE LAYER LAP							
WINDING PITCH	TWO THIRDS							
WINDING LEADS	6							
STATOR WDG. RESISTANCE	0.003 Ohms PER PHASE AT 22°C STAR CONNECTED							
ROTOR WDG. RESISTANCE	1.75 Ohms at 22°C							
EXCITER STATOR RESISTANCE	17 Ohms at 22°C							
EXCITER ROTOR RESISTANCE	0.079 Ohms PER PHASE AT 22°C							
R.F.I. SUPPRESSION	BS EN 61000-6-2 & BS EN 61000-6-4, VDE 0875G, VDE 0875N. refer to factory for others							
WAVEFORM DISTORTION	NO LOAD < 1.5% NON-DISTORTING BALANCED LINEAR LOAD < 5.0%							
MAXIMUM OVERSPEED	2250 Rev/Min							
BEARING DRIVE END	BALL. 6224 (ISO)							
BEARING NON-DRIVE END	BALL. 6317 (ISO)							
	1 BEARING				2 BEARING			
WEIGHT COMP. GENERATOR	1965 kg				1989 kg			
WEIGHT WOUND STATOR	934 kg				934 kg			
WEIGHT WOUND ROTOR	814 kg				766 kg			
WR ² INERTIA	18.3482 kgm ²				17.8009 kgm ²			
SHIPPING WEIGHTS in a crate	2023kg				2029kg			
PACKING CRATE SIZE	183 x 92 x 140(cm)				183 x 92 x 140(cm)			
	50 Hz				60 Hz			
TELEPHONE INTERFERENCE	THF<2%				TIF<50			
COOLING AIR	1.614 m ³ /sec 3420 cfm				1.961 m ³ /sec 4156 cfm			
VOLTAGE STAR	380/220	400/231	415/240	440/254	416/240	440/254	460/266	480/277
VOLTAGE DELTA	220	230	240	254	240	254	266	277
kVA BASE RATING FOR REACTANCE VALUES	800	800	800	800	875	925	963	1000
X _d DIR. AXIS SYNCHRONOUS	3.14	2.83	2.63	2.34	3.53	3.34	3.18	3.03
X' _d DIR. AXIS TRANSIENT	0.25	0.23	0.21	0.19	0.28	0.26	0.25	0.24
X'' _d DIR. AXIS SUBTRANSIENT	0.18	0.16	0.15	0.13	0.21	0.20	0.19	0.18
X _q QUAD. AXIS REACTANCE	1.88	1.70	1.58	1.40	2.10	1.98	1.89	1.80
X'' _q QUAD. AXIS SUBTRANSIENT	0.21	0.19	0.18	0.16	0.24	0.23	0.22	0.21
X _L LEAKAGE REACTANCE	0.10	0.09	0.08	0.07	0.12	0.11	0.10	0.10
X ₂ NEGATIVE SEQUENCE	0.22	0.20	0.19	0.17	0.24	0.23	0.22	0.21
X ₀ ZERO SEQUENCE	0.03	0.03	0.03	0.02	0.03	0.03	0.03	0.03
REACTANCES ARE SATURATED VALUES ARE PER UNIT AT RATING AND VOLTAGE INDICATED								
T' _d TRANSIENT TIME CONST.	0.185							
T'' _d SUB-TRANSTIME CONST.	0.025							
T' _{do} O.C. FIELD TIME CONST.	2.35							
T _a ARMATURE TIME CONST.	0.04							
SHORT CIRCUIT RATIO	1/X _d							

50
Hz

HCI634G
Winding 312

STAMFORD

THREE PHASE EFFICIENCY CURVES

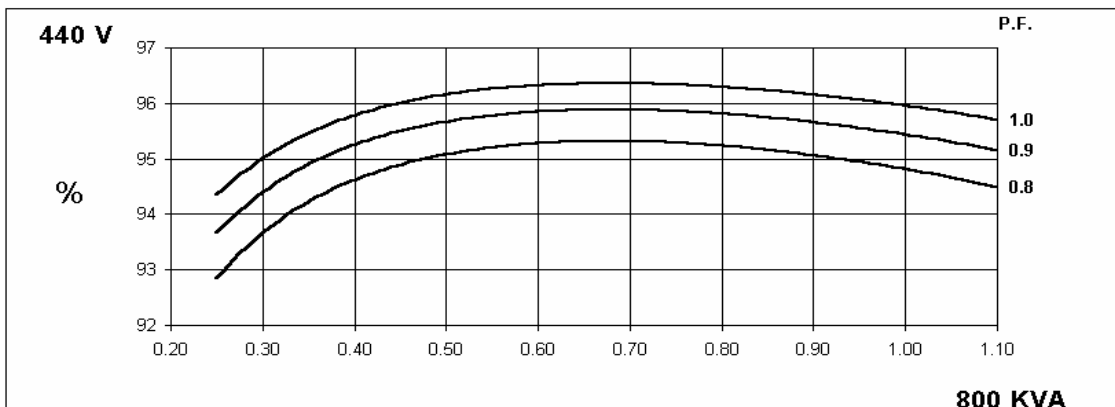
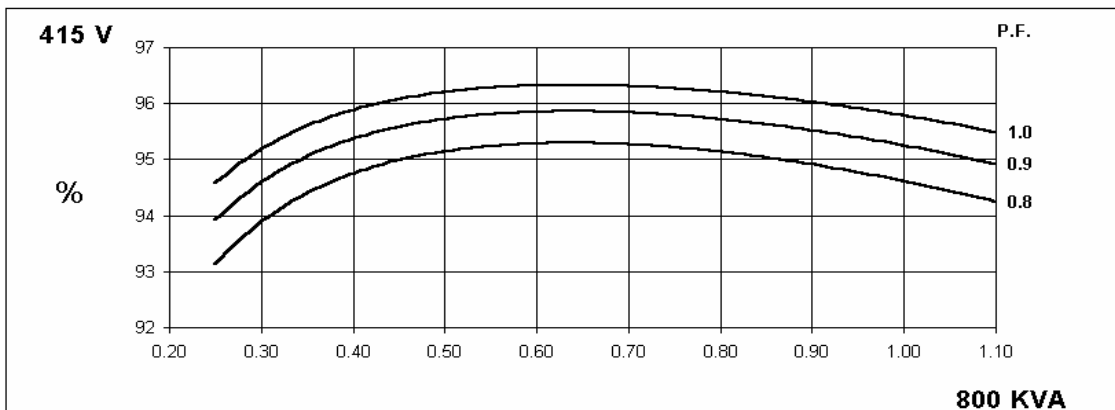
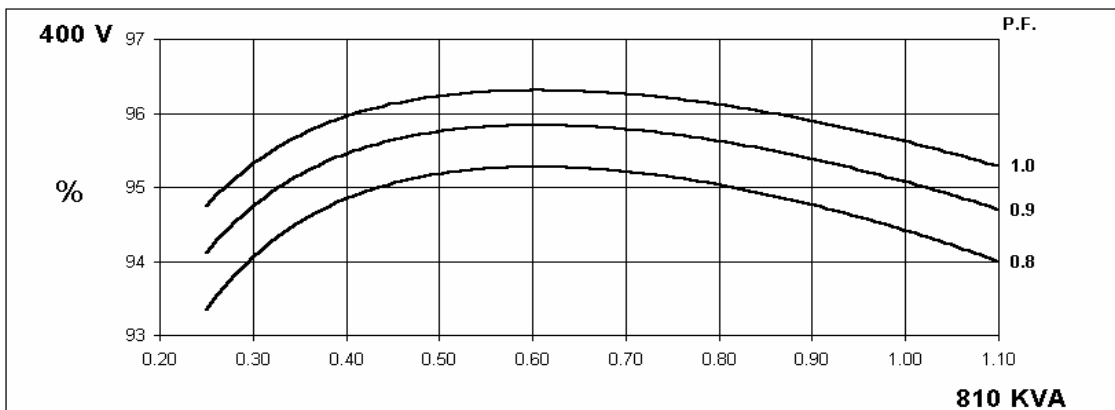
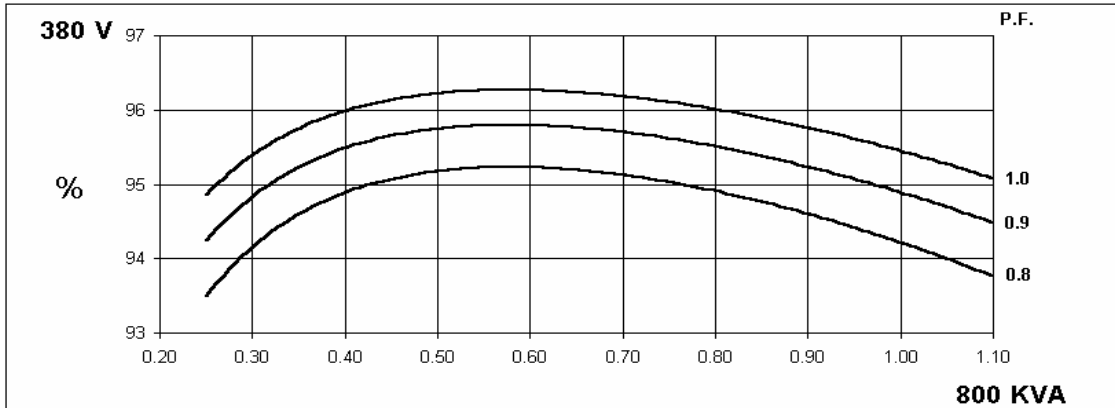

60
Hz

HCI634G
Winding 312

STAMFORD

THREE PHASE EFFICIENCY CURVES

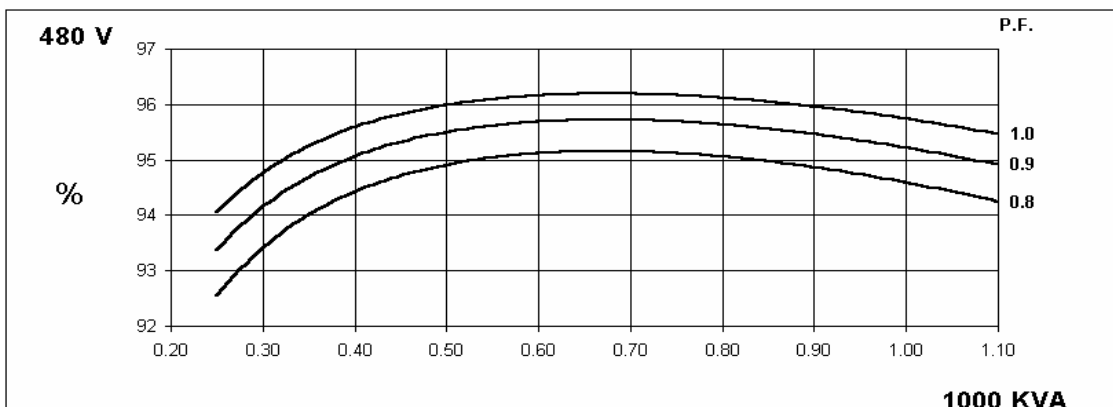
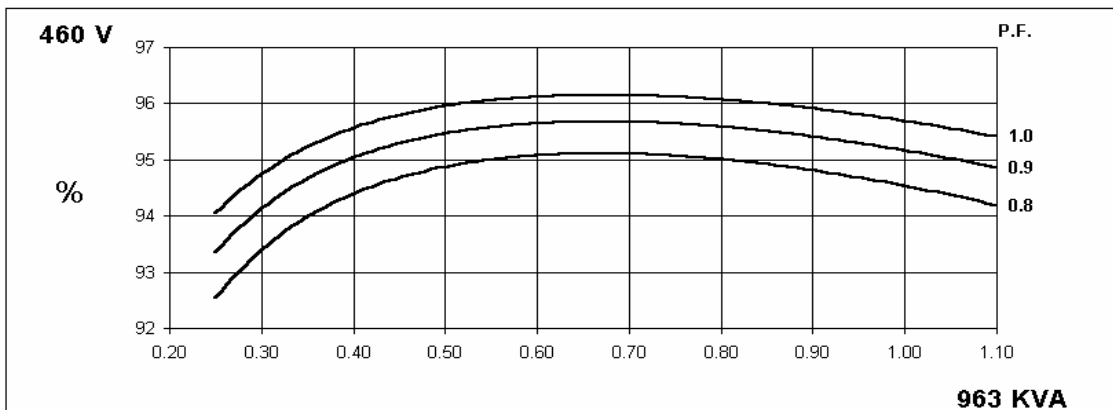
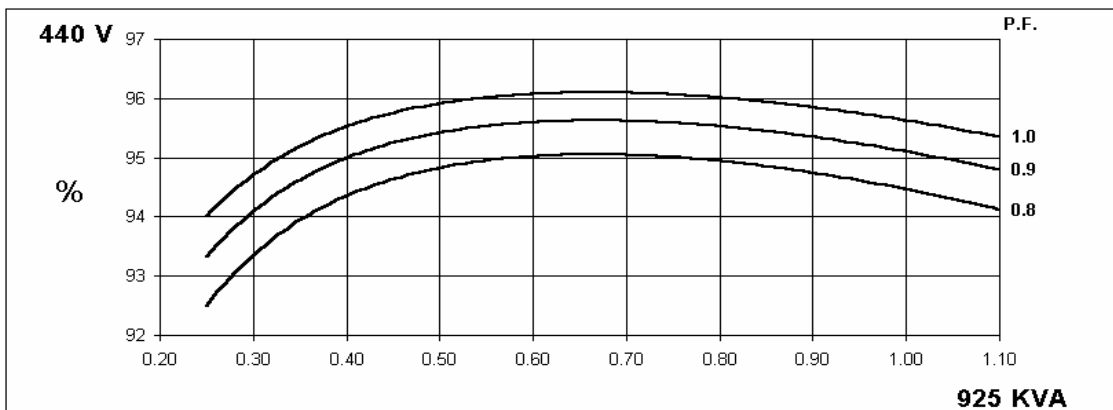
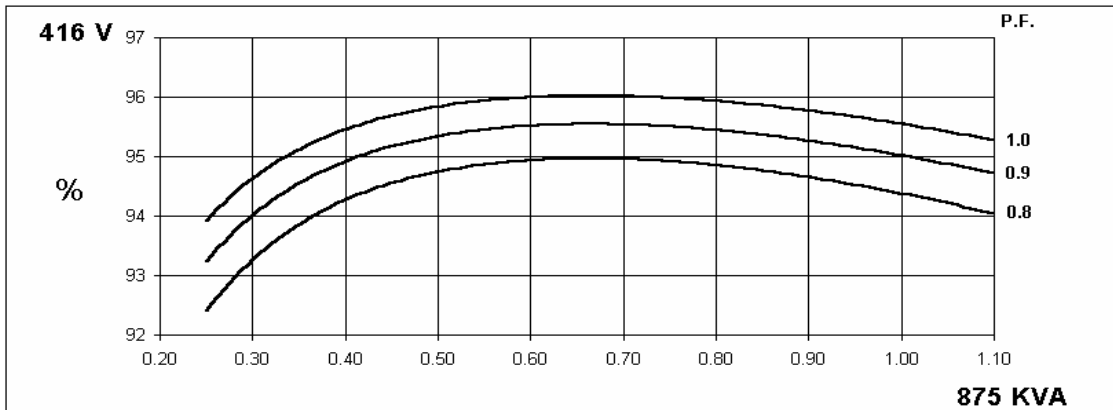

HCI634G
Winding 312

Locked Rotor Motor Starting Curve

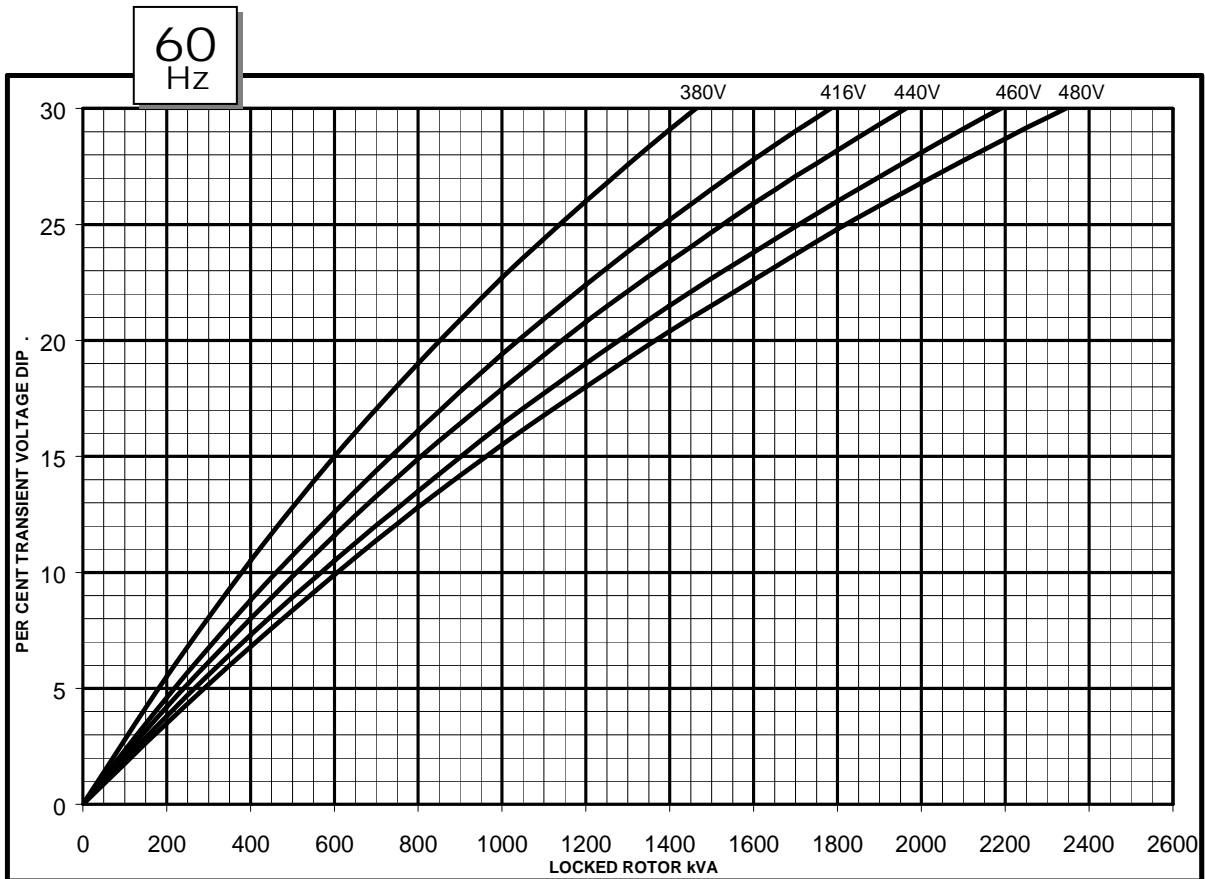
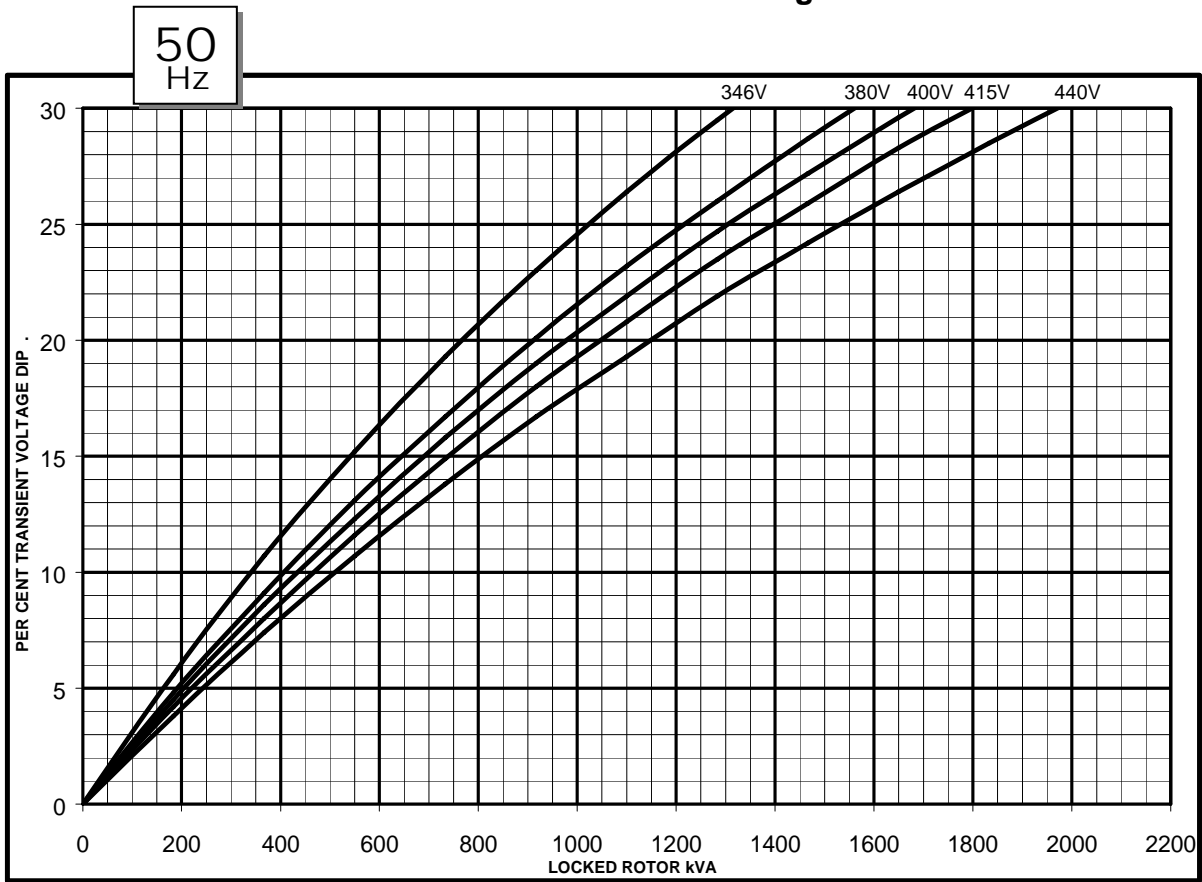

**Three-phase Short Circuit Decrement Curve. No-load Excitation at Rated Speed
Based on star (wye) connection.**

50
Hz

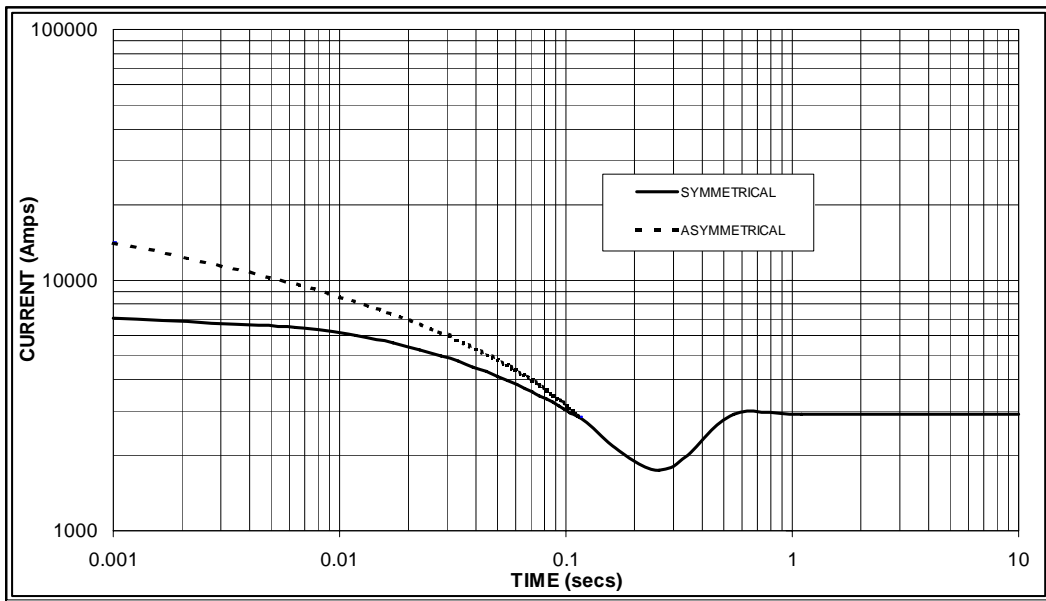

Sustained Short Circuit = 2,900 Amps

60
Hz

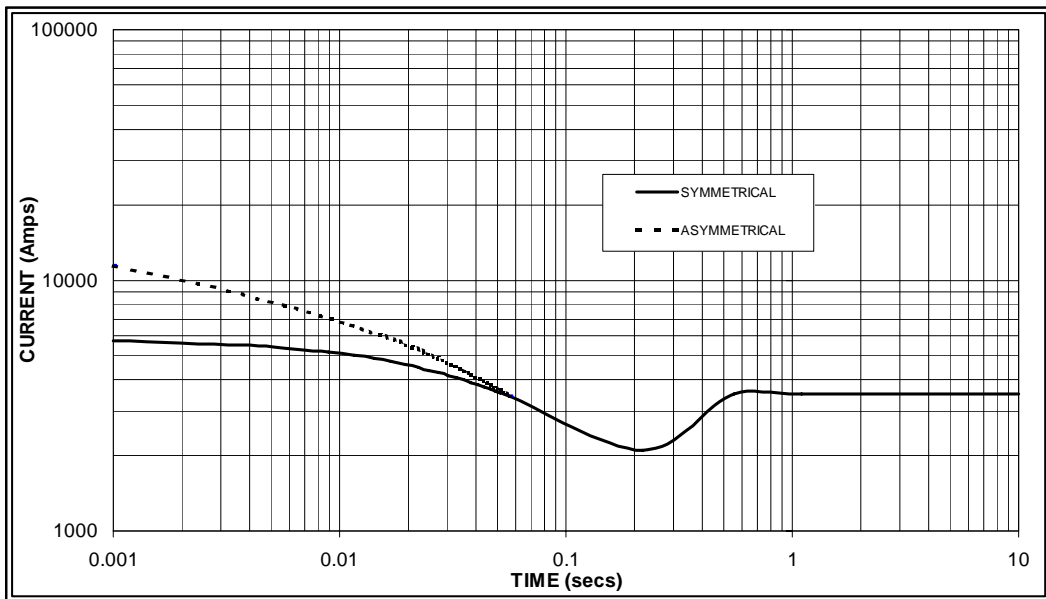

Sustained Short Circuit = 3,500 Amps

Note 1

The following multiplication factors should be used to adjust the values from curve between time 0.001 seconds and the minimum current point in respect of nominal operating voltage :

50Hz		60Hz	
Voltage	Factor	Voltage	Factor
380v	X 1.00	416v	x 1.00
400v	X 1.07	440v	x 1.06
415v	X 1.12	460v	x 1.12
440v	X 1.18	480v	x 1.17

The sustained current value is constant irrespective of voltage level

Note 2

The following multiplication factor should be used to convert the values calculated in accordance with NOTE 1 to those applicable to the various types of short circuit :

	3-phase	2-phase L-L	1-phase L-N
Instantaneous	x 1.00	x 0.87	x 1.30
Minimum	x 1.00	x 1.80	x 3.20
Sustained	x 1.00	x 1.50	x 2.50
Max. sustained duration	10 sec.	5 sec.	2 sec.

All other times are unchanged

Note 3

Curves are drawn for Star (Wye) connected machines. For Delta connection multiply the Curve current value by 1.732

HCI634G

Winding 312 0.8 Power Factor

RATINGS

Class - Temp Rise	Cont. F - 105/40°C				Cont. H - 125/40°C				Standby - 150/40°C				Standby - 163/27°C				
50Hz	Star (V)	380	400	415	440	380	400	415	440	380	400	415	440	380	400	415	440
	Delta (V)	220	230	240	254	220	230	240	254	220	230	240	254	220	230	240	254
	kVA	750	760	750	750	800	810	800	800	820	830	820	820	850	860	850	850
	kW	600	608	600	600	640	648	640	640	656	664	656	656	680	688	680	680
	Efficiency (%)	94.5	94.6	94.8	95.0	94.2	94.4	94.6	94.8	94.1	94.3	94.5	94.7	93.9	94.2	94.4	94.6
	kW Input	635	643	633	632	679	686	677	675	697	704	694	693	724	730	720	719

60Hz	Star (V)	416	440	460	480	416	440	460	480	416	440	460	480	416	440	460	480
	Delta (V)	240	254	266	277	240	254	266	277	240	254	266	277	240	254	266	277
	kVA	813	844	888	913	875	925	963	1000	913	969	1008	1046	950	1000	1044	1088
	kW	650	675	710	730	700	740	770	800	730	775	806	837	760	800	835	870
	Efficiency (%)	94.6	94.7	94.8	94.8	94.4	94.5	94.5	94.6	94.2	94.3	94.4	94.4	94.1	94.2	94.3	94.3
	kW Input	688	713	749	770	742	783	815	846	775	822	854	886	808	849	886	923

DIMENSIONS

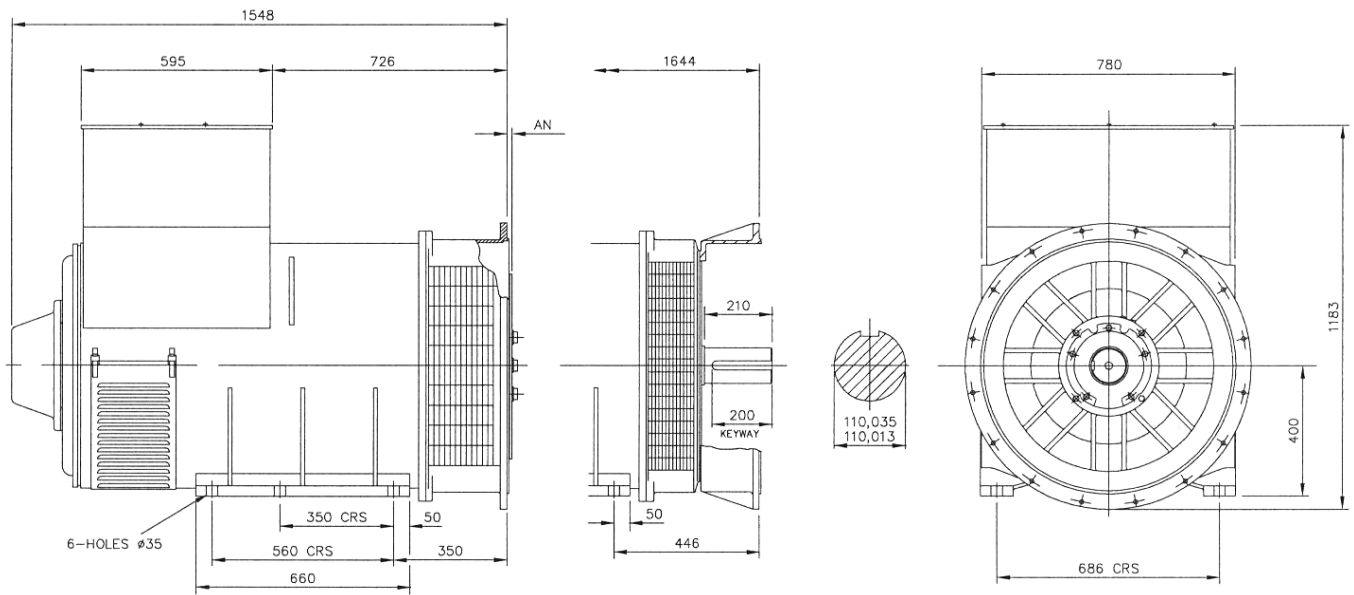

SAE	14	18	21	24
AN	25.4	15.87	0	0

NTA855-G4

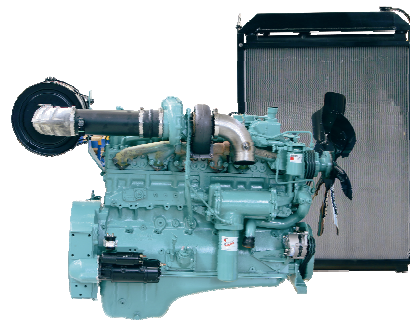

> Specification sheet

Our energy working for you.™



Description

The Cummins NT-Series engines have been service proven through millions of hours of operation in some of the world's most demanding applications. The 14 litre, six-cylinder NTA855 has been engineered to handle higher injection pressures, with redesigned overhead arrangement, pistons, crankshaft and camshaft. A gear train with high contact ratio spur gears also eliminates unwanted thrust loads and reduces noise.



This engine has been built to comply with CE certification.



This engine has been designed in facilities certified to ISO9001 and manufactured in facilities certified to ISO9001 or ISO9002.

Features

Cylinder Block - Alloy cast iron with removable wet liners.

Cylinder Heads - Alloy cast iron. Each head serves two cylinders. Drilled fuel supply and return lines. Valve seat inserts are replaceable and corrosion resistant. Valve and crosshead guides are replaceable.

Cylinder Liners - Replaceable wet liners dissipate heat faster than dry liners and are easily replaced without reboring the block.

Fuel System - Cummins PT™ self adjusting system. Integral dual flyweight governor provides overspeed protection independent of main governor. Camshaft actuated fuel injectors give accurate metering and timing. Dual spin-on fuel filters.

Coolpac Integrated Design - Products are supplied complete with cooling package and air cleaner kit for a complete power package. Each component has been specifically developed and rigorously tested for G-Drive products, ensuring high performance, durability and reliability.

Service and Support - G-Drive products are backed by an uncompromising level of technical support and after sales service, delivered through a world class service network.

1500 rpm (50 Hz Ratings)

Gross Engine Output			Net Engine Output			Typical Generator Set Output					
Standby	Prime	Base	Standby	Prime	Base	Standby (ESP)		Prime (PRP)		Base (COP)	
kWm/BHP			kWm/BHP			kWe	kVA	kWe	kVA	kWe	kVA
351/471	317/425	272/365	337/451	307/411	262/351	320	400	292	365	245	306

1800 rpm (60 Hz Ratings)

Gross Engine Output			Net Engine Output			Typical Generator Set Output					
Standby	Prime	Base	Standby	Prime	Base	Standby (ESP)		Prime (PRP)		Base (COP)	
kWm/BHP			kWm/BHP			kWe	kVA	kWe	kVA	kWe	kVA
N/A	N/A	N/A	N/A	N/A	N/A	N/A	N/A	N/A	N/A	N/A	N/A



General Engine Data

Type	4 cycle, in-line, Turbo Charged
Bore mm	140 mm (5.5 in.)
Stroke mm	152 mm (6.0 in.)
Displacement Litre	14.0 litre (855 in. ³)
Cylinder Block	Cast iron, 6 cylinder
Battery Charging Alternator	55 amps
Starting Voltage	24 volt, negative ground
Fuel System	Direct injection
Fuel Filter	Spin-on fuel filters with water separator
Lube Oil Filter Type(s)	Spin-on full flow filter
Lube Oil Capacity (l)	38.6
Flywheel Dimensions	1/14

Coolpac Performance Data

Cooling System Design	Jacket Water After Cooled
Coolant Ratio	50% ethylene glycol; 50% water
Coolant Capacity (l)	45.0
Limiting Ambient Temp.**	54.7
Fan Power	11.6
Cooling System Air Flow (m ³ /s)**	7.6
Air Cleaner Type	Dry replaceable element with restriction indicator

** @ 13 mm H₂O

Weight & Dimensions

Length mm	Width mm	Height mm	Weight (dry) kg
2055	990	1535	1410

Fuel Consumption 1500 (50 Hz)

%	kWm	BHP	L/ph	US gal/ph
Standby Power				
100	351	471	84	21.8
Prime Power				
100	317	425	76	19.8
75	238	319	57	14.8
50	159	213	39	10.1
25	79	106	21	5.5
Continuous Power				
100	272	365	65	16.9

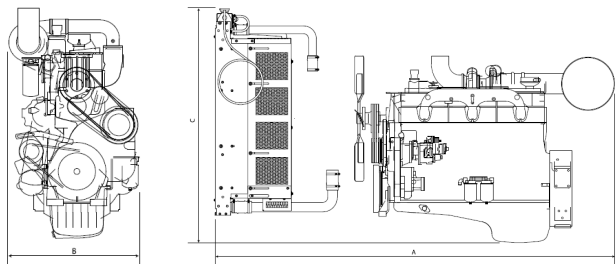

Fuel Consumption 1800 (60 Hz)

%	kWm	BHP	L/ph	US gal/ph
Standby Power				
100	N/A	N/A	N/A	0.0
Prime Power				
100	N/A	N/A	N/A	0.0
75	N/A	N/A	N/A	0.0
50	N/A	N/A	N/A	0.0
25	N/A	N/A	N/A	0.0
Continuous Power				
100	N/A	N/A	N/A	0.0

Ratings Definitions

Emergency Standby Power (ESP):

Applicable for supplying power to varying electrical load for the duration of power interruption of a reliable utility source. Emergency Standby Power (ESP) is in accordance with ISO 3046, AS 2789, DIN 6271 and BS 5514.

Limited-Time Running Power (LTP):

Applicable for supplying power to a constant electrical load for limited hours. Limited-Time Running Power (LTP) is in accordance with ISO 8528.

Prime Power (PRP):

Applicable for supplying power to varying electrical load for unlimited hours. Prime Power (PRP) is in accordance with ISO 8528. Ten percent overload capability is available in accordance with ISO 3046, AS 2789, DIN 6271 and BS 5514.

Base Load (Continuous) Power (COP):

Applicable for supplying power continuously to a constant electrical load for unlimited hours. Continuous Power (COP) in accordance with ISO 8528, ISO 3046, AS 2789, DIN6271 and BS 5514.

Cummins G-Drive Engines

Asia Pacific

10 Toh Guan Road
#07-01
TT International Tradepark
Singapore 608838
Phone 65 6417 2388
Fax 65 6417 2399

Europe, CIS, Middle East and Africa

Manston Park Columbus Ave
Manston Ramsgate
Kent CT12 5BF, UK
Phone 44 1843 255000
Fax 44 1843 255902

Latin America

Rua Jati, 310, Cumbica
Guarulhos, SP 07180-900
Brazil
Phone 55 11 2186 4552
Fax 55 11 2186 4729

Mexico

Cummins S. de R.L. de C.V.
Eje 122 No. 200 Zona Industrial
San Luis Potosi, S.L.P. 78090
Mexico
Phone 52 444 870 6700
Fax 52 444 870 6811

North America

1400 73rd Avenue N.E.
Minneapolis, MN 55432
USA
Phone 1 763 574 5000
USA Toll-free 1 877 769 7669
Fax 1 763 574 5298



STAMFORD®

HCI 434E/444E - Technical Data Sheet

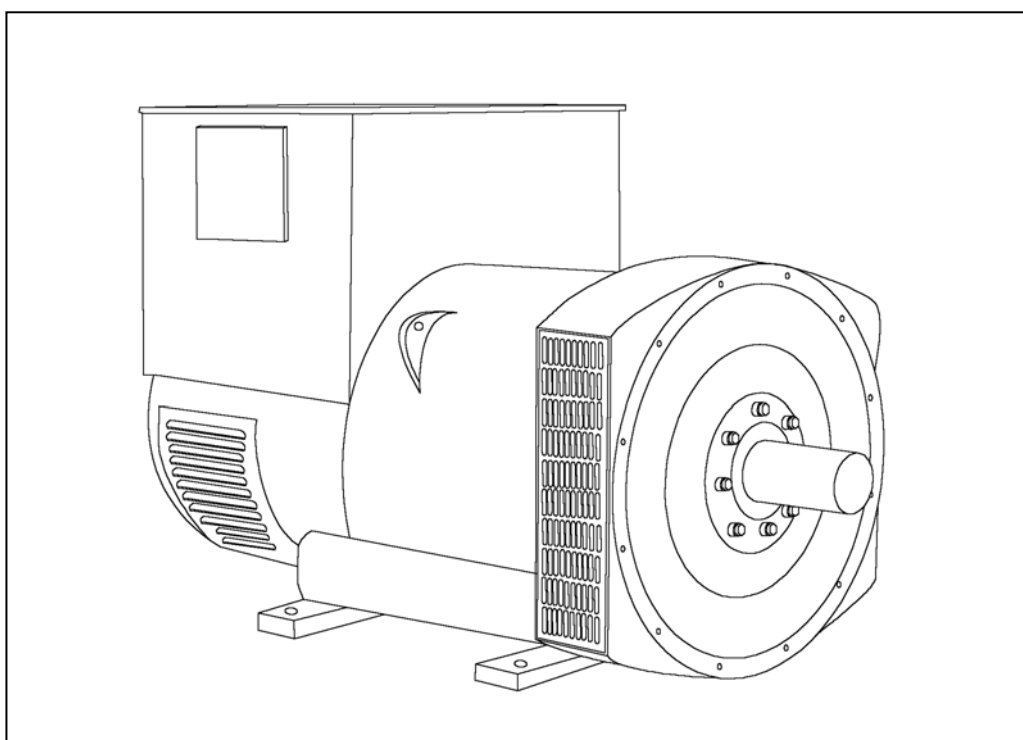

HCI434E/444E

SPECIFICATIONS & OPTIONS

STAMFORD

STANDARDS

Newage Stamford industrial generators meet the requirements of BS EN 60034 and the relevant section of other international standards such as BS5000, VDE 0530, NEMA MG1-32, IEC34, CSA C22.2-100, AS1359. Other standards and certifications can be considered on request.

VOLTAGE REGULATORS

AS440 AVR - STANDARD

With this self-excited system the main stator provides power via the Automatic Voltage Regulator (AVR) to the exciter stator. The high efficiency semi-conductors of the AVR ensure positive build-up from initial low levels of residual voltage.

The exciter rotor output is fed to the main rotor through a three-phase full-wave bridge rectifier. The rectifier is protected by a surge suppressor against surges caused, for example, by short circuit or out-of-phase paralleling.

The AS440 will support a range of electronic accessories, including a 'droop' Current Transformer (CT) to permit parallel operation with other ac generators.

MX341 AVR

This sophisticated AVR is incorporated into the Stamford Permanent Magnet Generator (PMG) control system.

The PMG provides power via the AVR to the main exciter, giving a source of constant excitation power independent of generator output. The main exciter output is then fed to the main rotor, through a full wave bridge, protected by a surge suppressor. The AVR has in-built protection against sustained over-excitation, caused by internal or external faults. This de-excites the machine after a minimum of 5 seconds.

An engine relief load acceptance feature can enable full load to be applied to the generator in a single step.

If three-phase sensing is required with the PMG system the MX321 AVR must be used.

We recommend three-phase sensing for applications with greatly unbalanced or highly non-linear loads.

MX321 AVR

The most sophisticated of all our AVRs combines all the features of the MX341 with, additionally, three-phase rms sensing, for improved regulation and performance. Over voltage protection is built-in and short circuit current level adjustments is an optional facility.

WINDINGS & ELECTRICAL PERFORMANCE

All generator stators are wound to 2/3 pitch. This eliminates triplen (3rd, 9th, 15th ...) harmonics on the voltage waveform and is found to be the optimum design for trouble-free supply of non-linear loads. The 2/3 pitch design avoids excessive neutral currents sometimes seen with higher winding pitches, when in parallel with the mains. A fully connected damper winding reduces oscillations during paralleling. This winding, with the 2/3 pitch and carefully selected pole and tooth designs, ensures very low waveform distortion.

TERMINALS & TERMINAL BOX

Standard generators are 3-phase reconnectable with 12 ends brought out to the terminals, which are mounted on a cover at the non-drive end of the generator. A sheet steel terminal box contains the AVR and provides ample space for the customers' wiring and gland arrangements. It has removable panels for easy access.

SHAFT & KEYS

All generator rotors are dynamically balanced to better than BS6861:Part 1 Grade 2.5 for minimum vibration in operation. Two bearing generators are balanced with a half key.

INSULATION/IMPREGNATION

The insulation system is class 'H'.

All wound components are impregnated with materials and processes designed specifically to provide the high build required for static windings and the high mechanical strength required for rotating components.

QUALITY ASSURANCE

Generators are manufactured using production procedures having a quality assurance level to BS EN ISO 9001.

The stated voltage regulation may not be maintained in the presence of certain radio transmitted signals. Any change in performance will fall within the limits of Criteria 'B' of EN 61000-6-2:2001. At no time will the steady-state voltage regulation exceed 2%.

NB Continuous development of our products entitles us to change specification details without notice, therefore they must not be regarded as binding.

Front cover drawing typical of product range.

HCI434E/444E



WINDING 311

CONTROL SYSTEM	SEPARATELY EXCITED BY P.M.G.							
A.V.R.	MX321	MX341						
VOLTAGE REGULATION	± 0.5 %	± 1.0 %	With 4% ENGINE GOVERNING					
SUSTAINED SHORT CIRCUIT	REFER TO SHORT CIRCUIT DECREMENT CURVES (page 7)							
CONTROL SYSTEM	SELF EXCITED							
A.V.R.	AS440							
VOLTAGE REGULATION	± 1.0 %	With 4% ENGINE GOVERNING						
SUSTAINED SHORT CIRCUIT	WILL NOT SUSTAIN A SHORT CIRCUIT							
INSULATION SYSTEM	CLASS H							
PROTECTION	IP23							
RATED POWER FACTOR	0.8							
STATOR WINDING	DOUBLE LAYER LAP							
WINDING PITCH	TWO THIRDS							
WINDING LEADS	12							
STATOR WDG. RESISTANCE	0.009 Ohms PER PHASE AT 22°C SERIES STAR CONNECTED							
ROTOR WDG. RESISTANCE	1.19 Ohms at 22°C							
EXCITER STATOR RESISTANCE	18 Ohms at 22°C							
EXCITER ROTOR RESISTANCE	0.068 Ohms PER PHASE AT 22°C							
R.F.I. SUPPRESSION	BS EN 61000-6-2 & BS EN 61000-6-4, VDE 0875G, VDE 0875N. refer to factory for others							
WAVEFORM DISTORTION	NO LOAD < 1.5% NON-DISTORTING BALANCED LINEAR LOAD < 5.0%							
MAXIMUM OVERSPEED	2250 Rev/Min							
BEARING DRIVE END	BALL. 6317 (ISO)							
BEARING NON-DRIVE END	BALL. 6314 (ISO)							
	1 BEARING				2 BEARING			
WEIGHT COMP. GENERATOR	1024 kg				1030 kg			
WEIGHT WOUND STATOR	470 kg				470 kg			
WEIGHT WOUND ROTOR	400 kg				377 kg			
WR ² INERTIA	4.6331 kgm ²				4.4343 kgm ²			
SHIPPING WEIGHTS in a crate	1095 kg				1100 kg			
PACKING CRATE SIZE	155 x 87 x 107(cm)				155 x 87 x 107(cm)			
	50 Hz				60 Hz			
TELEPHONE INTERFERENCE	THF<2%				TIF<50			
COOLING AIR	0.8 m ³ /sec 1700 cfm				0.99 m ³ /sec 2100 cfm			
VOLTAGE SERIES STAR	380/220	400/231	415/240	440/254	416/240	440/254	460/266	480/277
VOLTAGE PARALLEL STAR	190/110	200/115	208/120	220/127	208/120	220/127	230/133	240/138
VOLTAGE SERIES DELTA	220/110	230/115	240/120	254/127	240/120	254/127	266/133	277/138
KVA BASE RATING FOR REACTANCE VALUES	350	350	350	350	400	420	440	440
X _d DIR. AXIS SYNCHRONOUS	3.01	2.71	2.52	2.24	3.47	3.26	3.12	2.87
X' _d DIR. AXIS TRANSIENT	0.20	0.18	0.17	0.15	0.21	0.20	0.19	0.17
X'' _d DIR. AXIS SUBTRANSIENT	0.14	0.13	0.12	0.11	0.15	0.14	0.13	0.12
X _q QUAD. AXIS REACTANCE	2.58	2.33	2.16	1.92	2.92	2.74	2.63	2.41
X'' _q QUAD. AXIS SUBTRANSIENT	0.36	0.32	0.30	0.27	0.41	0.38	0.37	0.34
X _L LEAKAGE REACTANCE	0.07	0.06	0.06	0.05	0.08	0.08	0.07	0.07
X ₂ NEGATIVE SEQUENCE	0.24	0.22	0.20	0.18	0.28	0.26	0.25	0.23
X ₀ ZERO SEQUENCE	0.10	0.09	0.08	0.07	0.10	0.09	0.09	0.08
REACTANCES ARE SATURATED				VALUES ARE PER UNIT AT RATING AND VOLTAGE INDICATED				
T' _d TRANSIENT TIME CONST.	0.08s							
T'' _d SUB-TRANSTIME CONST.	0.019s							
T' _{do} O.C. FIELD TIME CONST.	1.7s							
T _a ARMATURE TIME CONST.	0.018s							
SHORT CIRCUIT RATIO	1/X _d							

50
Hz

HCI434E/444E

STAMFORD

Winding 311

THREE PHASE EFFICIENCY CURVES

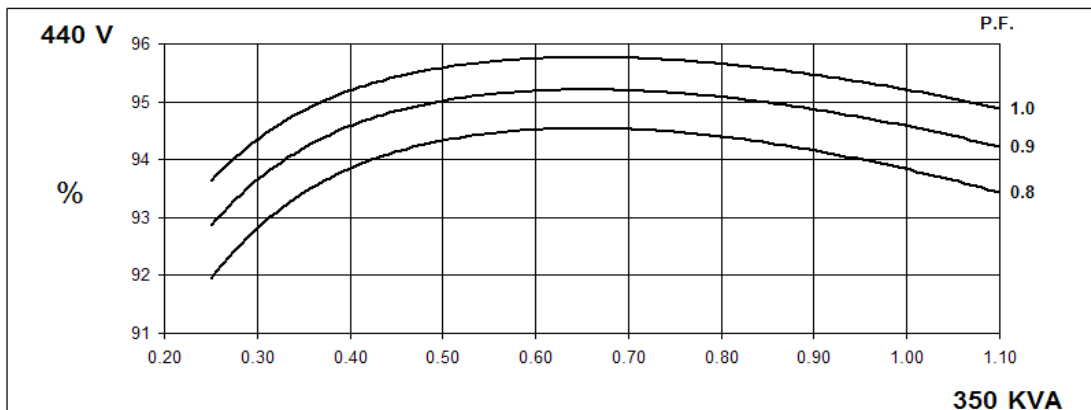
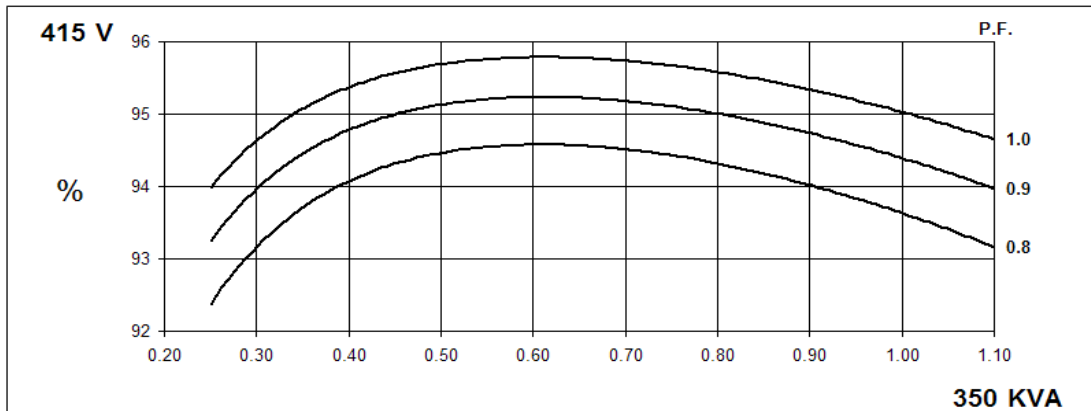
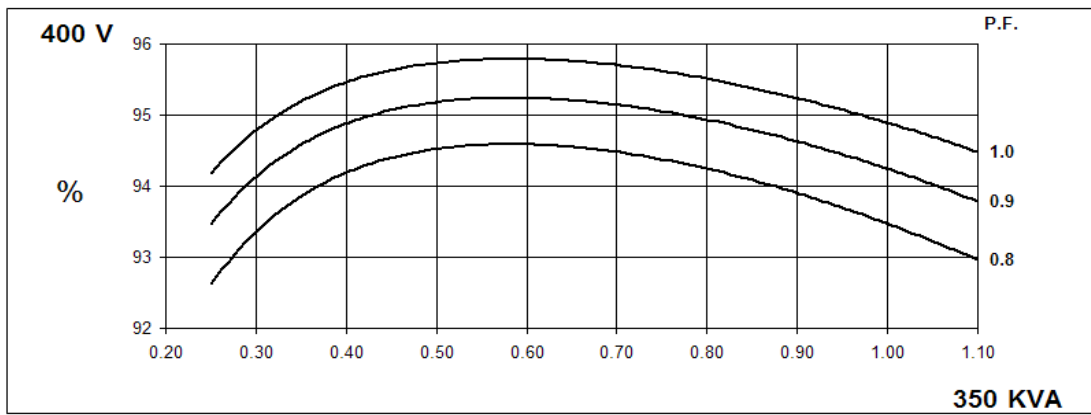
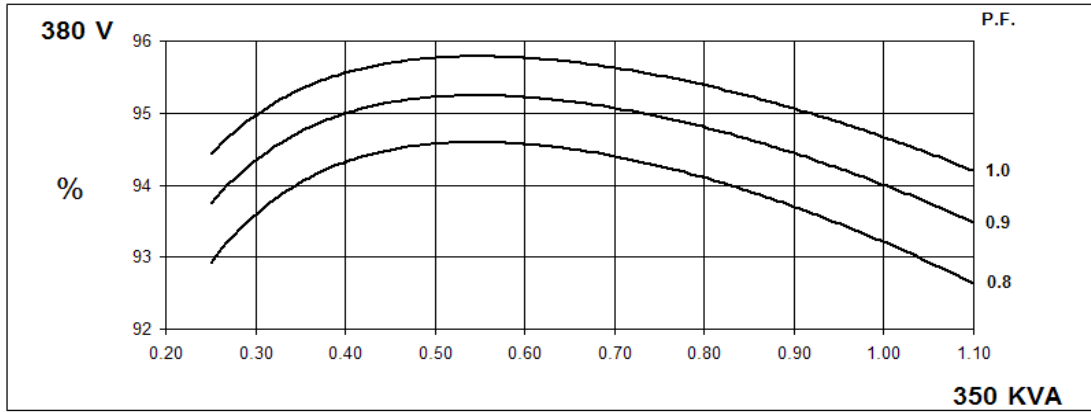

60
Hz

HCI434E/444E

STAMFORD

Winding 311

THREE PHASE EFFICIENCY CURVES

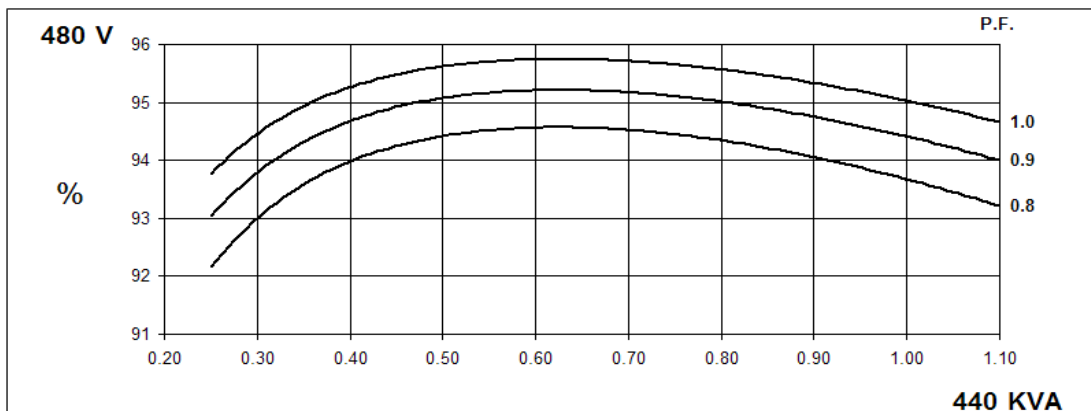
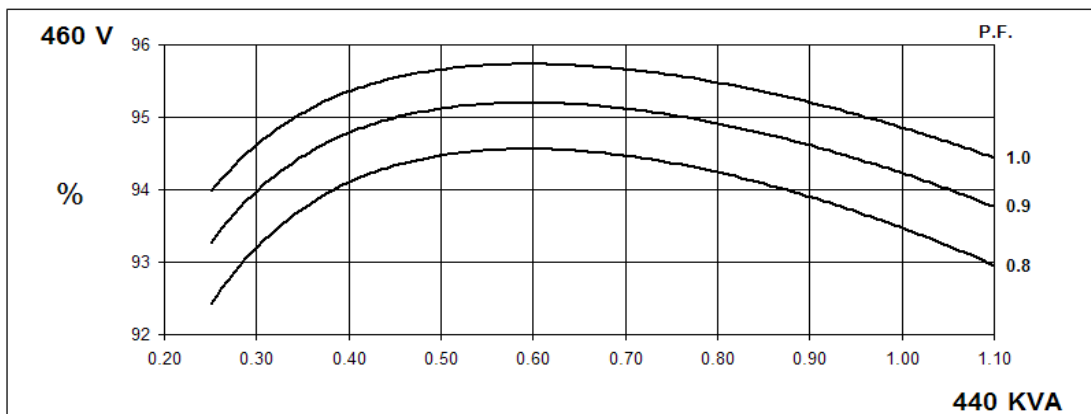
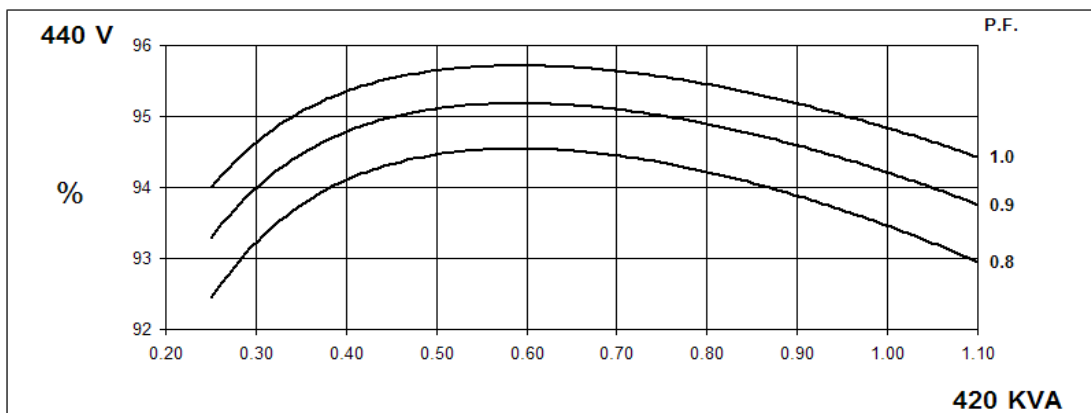
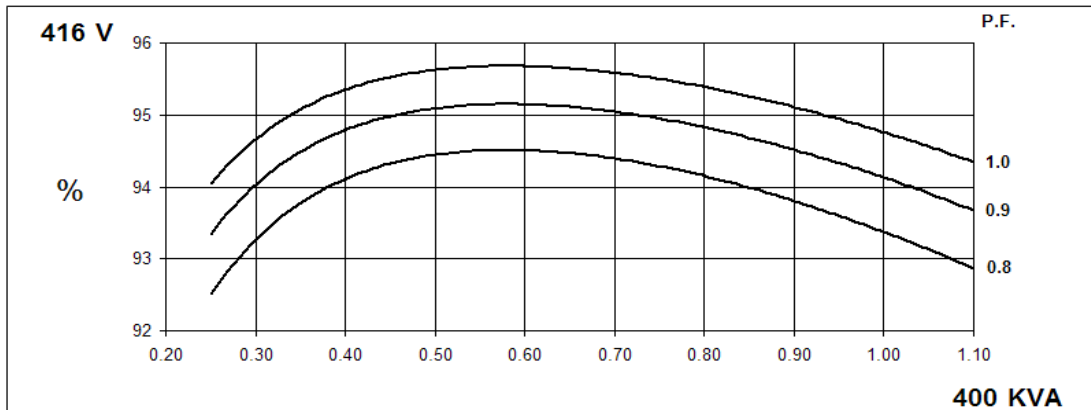

Locked Rotor Motor Starting Curve

50
Hz

MX

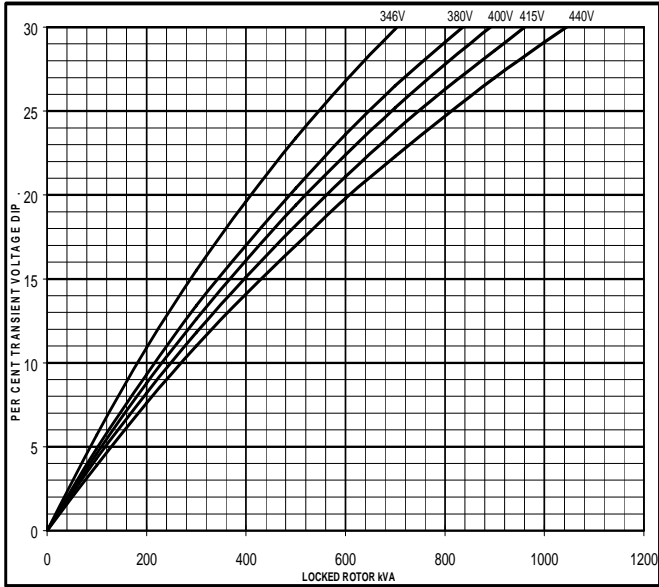

SX

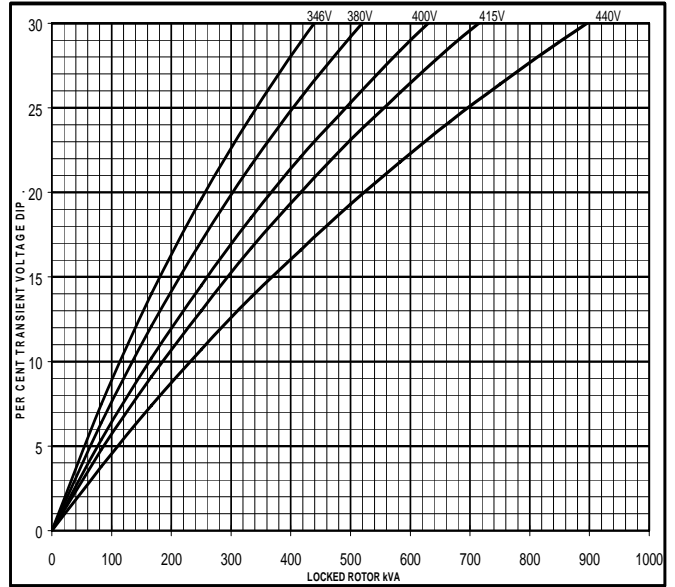

60
Hz

MX

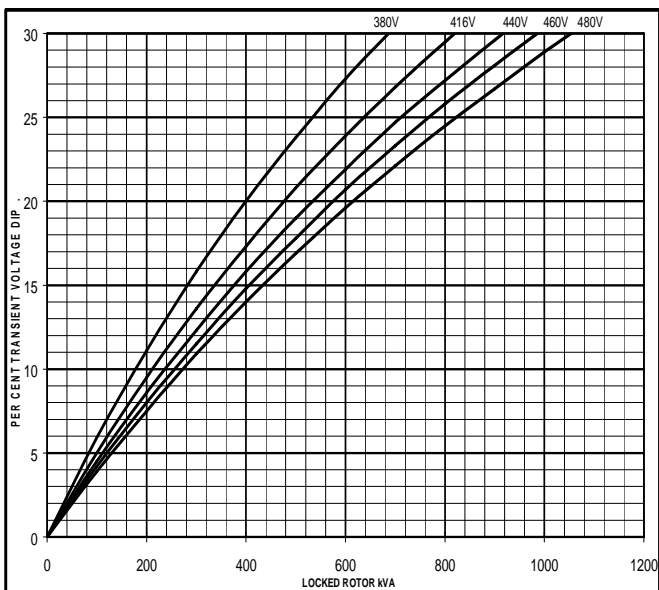

SX

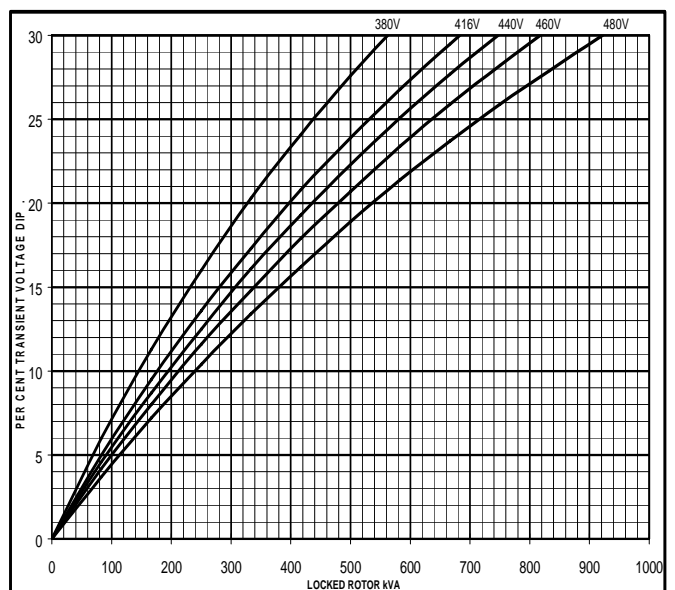

**Three-phase Short Circuit Decrement Curve. No-load Excitation at Rated Speed
Based on star (wye) connection.**

**50
Hz**

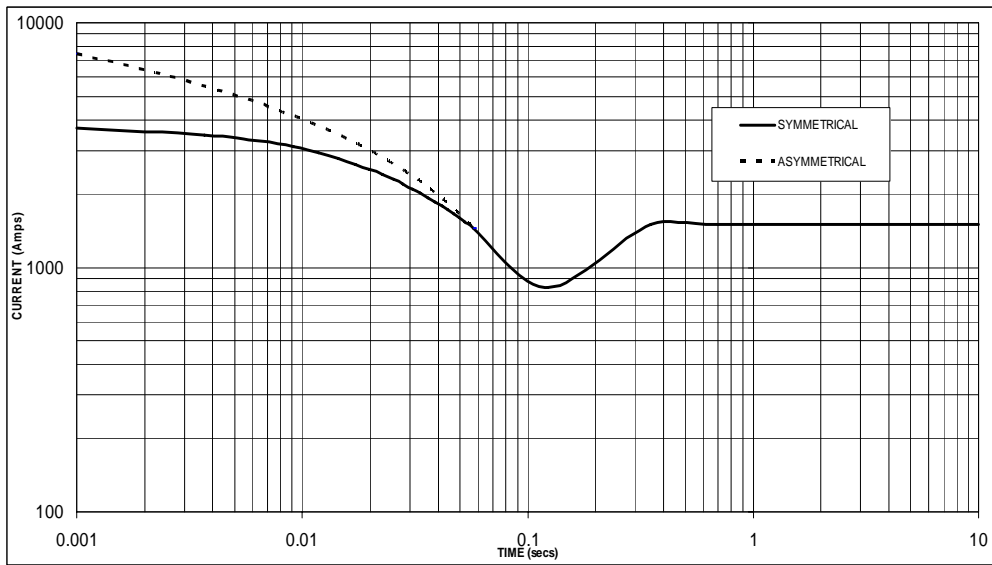

Sustained Short Circuit = 1,500 Amps

**60
Hz**

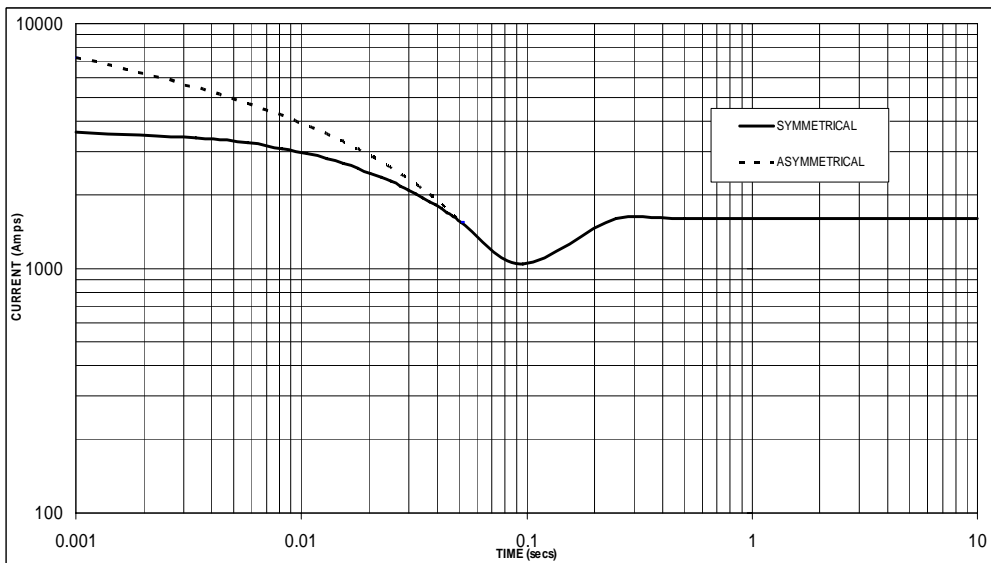

Sustained Short Circuit = 1,600 Amps

Note 1

The following multiplication factors should be used to adjust the values from curve between time 0.001 seconds and the minimum current point in respect of nominal operating voltage :

50Hz		60Hz	
Voltage	Factor	Voltage	Factor
380v	X 1.00	416v	X 1.00
400v	X 1.05	440v	X 1.06
415v	X 1.10	460v	X 1.10
440v	X 1.16	480v	X 1.15

The sustained current value is constant irrespective of voltage level

Note 2

The following multiplication factor should be used to convert the values calculated in accordance with NOTE 1 to those applicable to the various types of short circuit :

	3-phase	2-phase L-L	1-phase L-N
Instantaneous	x 1.00	x 0.87	x 1.30
Minimum	x 1.00	x 1.80	x 3.20
Sustained	x 1.00	x 1.50	x 2.50
Max. sustained duration	10 sec.	5 sec.	2 sec.

All other times are unchanged

Note 3

Curves are drawn for Star (Wye) connected machines. For other connection the following multipliers should be applied to current values as shown :

HCI434E/444E

Winding 311 / 0.8 Power Factor

STAMFORD

RATINGS

Class - Temp Rise	Cont. F - 105/40°C				Cont. H - 125/40°C				Standby - 150/40°C				Standby - 163/27°C				
50 Hz	Series Star (V)	380	400	415	440	380	400	415	440	380	400	415	440	380	400	415	440
	Parallel Star (V)	190	200	208	220	190	200	208	220	190	200	208	220	190	200	208	220
	Series Delta (V)	220	230	240	254	220	230	240	254	220	230	240	254	220	230	240	254
kVA	320	320	320	320	350	350	350	350	370	370	370	370	380	400	380	380	
kW	256	256	256	256	280	280	280	280	296	296	296	296	304	320	304	304	
Efficiency (%)	93.6	93.8	94.0	94.1	93.2	93.5	93.6	93.8	92.9	93.2	93.4	93.6	92.7	92.7	93.2	93.5	
kW Input	274	273	272	272	300	299	299	299	319	318	317	316	328	345	326	325	

60 Hz	Series Star (V)	416	440	460	480	416	440	460	480	416	440	460	480	416	440	460	480
	Parallel Star (V)	208	220	230	240	208	220	230	240	208	220	230	240	208	220	230	240
	Series Delta (V)	240	254	266	277	240	254	266	277	240	254	266	277	240	254	266	277
kVA	365	385	400	400	400	420	440	440	420	445	460	460	435	455	475	475	
kW	292	308	320	320	320	336	352	352	336	356	368	368	348	364	380	380	
Efficiency (%)	93.8	93.8	93.9	94.0	93.4	93.5	93.5	93.7	93.1	93.2	93.2	93.5	92.9	93.0	93.1	93.3	
kW Input	311	328	341	340	343	359	376	376	361	382	395	394	375	391	408	407	

DIMENSIONS

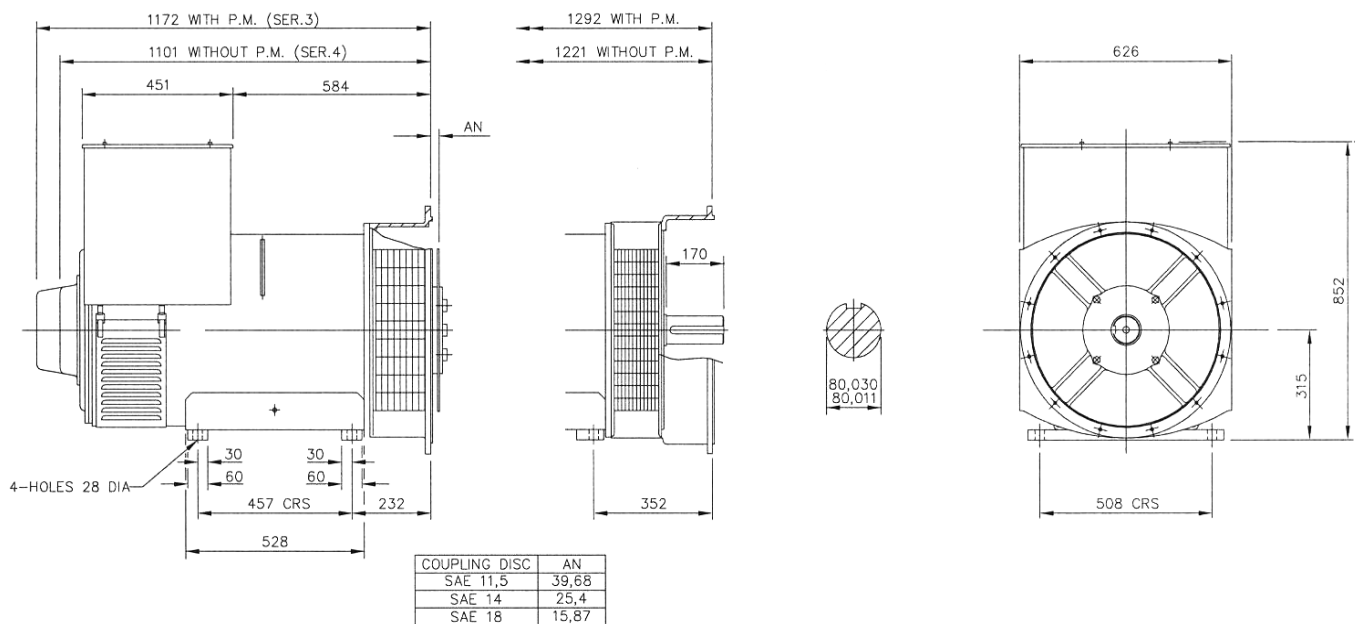

STAMFORD

Barnack Road • Stamford • Lincolnshire • PE9 2NB
Tel: 00 44 (0)1780 484000 • Fax: 00 44 (0)1780 484100

NT855-G6

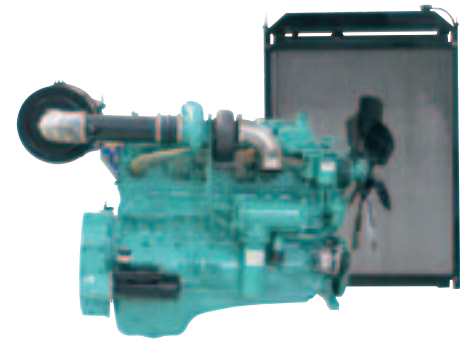

> Specification sheet

Our energy working for you.™



Description

The Cummins NT-Series engines have been service proven through millions of hours of operation in some of the world's most demanding applications. The 14 litre, six-cylinder NT855 has been engineered to handle higher injection pressures, with redesigned overhead arrangement, pistons, crankshaft and camshaft. A gear train with high contact ratio spur gears also eliminates unwanted thrust loads and reduces noise.



This engine has been built to comply with CE certification.



This engine has been designed in facilities certified to ISO9001 and manufactured in facilities certified to ISO9001 or ISO9002.

Features

Cylinder Block - Alloy cast iron with removable wet liners.

Cylinder Heads - Alloy cast iron. Each head serves two cylinders. Drilled fuel supply and return lines. Valve seat inserts are replaceable and corrosion resistant. Valve and crosshead guides are replaceable.

Cylinder Liners - Replaceable wet liners dissipate heat faster than dry liners and are easily replaced without reborring the block.

Fuel System - Cummins PT™ self adjusting system. Integral dual flyweight governor provides overspeed protection independent of main governor. Camshaft actuated fuel injectors give accurate metering and timing. Dual spin-on fuel filters.

Coolpac Integrated Design - products are supplied complete with cooling package and air cleaner kit for a complete power package. Each component has been specifically developed and rigorously tested for G-Drive products, ensuring high performance, durability and reliability.

Service and Support - G-Drive products are backed by an uncompromising level of technical support and after sales service, delivered through a world class service network.

1500 rpm (50 Hz) Ratings

Gross Engine Output			Net Engine Output			Typical Generator Set Output					
Standby	Prime	Base	Standby	Prime	Base	Standby (ESP)		Prime (PRP)		Base (COP)	
kWm/BHP			kWm/BHP			kWe	kVA	kWe	kVA	kWe	kVA
310/416	280/375	231/310	310/415	280/375	231/309	280	350	256	320	207	259

1800 rpm (60 Hz) Ratings

Gross Engine Output			Net Engine Output			Typical Generator Set Output					
Standby	Prime	Base	Standby	Prime	Base	Standby (ESP)		Prime (PRP)		Base (COP)	
kWm/BHP			kWm/BHP			kWe	kVA	kWe	kVA	kWe	kVA
325/436	295/396	254/341	311/417	281/377	240/322	285	356	260	325	222	277

General Engine Data

Type	4 cycle, in-line, Turbo Charged
Bore mm	140 mm (5.5 in.)
Stroke mm	152 mm (6.0 in.)
Displacement Litre	14.0 litre (855 in. ³)
Cylinder Block	Cast iron, 6 cylinder
Battery Charging Alternator	55 amps
Starting Voltage	24 volt, negative ground
Fuel System	Direct injection
Fuel Filter	Spin-on fuel filters with water separator
Lube Oil Filter Type(s)	Spin-on full flow filter
Lube Oil Capacity (l)	38.6
Flywheel Dimensions	1/14

Coolpac Performance Data

Cooling System Design	Jacket Water
Coolant Ratio	50% ethylene glycol; 50% water
Coolant Capacity (l)	45.0
Limiting Ambient Temp.**	58.0
Fan Power	11.6
Cooling system air flow (m ³ /s)**	7.6
Air Cleaner Type	Dry replaceable element with restriction indicator

** @ 13 mm H₂O

Weights & Dimension

Length	Width	Height	Weight (dry)
mm	mm	mm	kg
2055	990	1535	1410

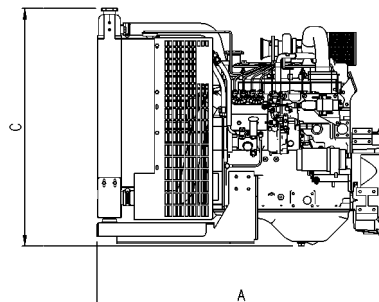
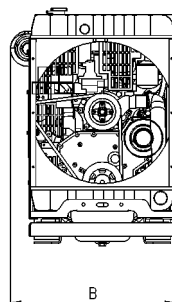

Fuel Consumption 1500 (50 Hz)

%	kWm	BHP	L/ph	US gal/ph
Standby Power				
100	310	416	76	19.8
Prime Power				
100	280	375	69	17.9
75	210	282	52	13.5
50	140	188	36	9.4
25	70	94	20	5.2
Continuous Power				
100	231	310	57	14.8

Fuel Consumption 1800 (60 Hz)

%	kWm	BHP	L/ph	US gal/ph
Standby Power				
100	325	436	82	21.3
Prime Power				
100	295	396	74	19.2
75	221	297	56	14.6
50	148	198	40	10.4
25	74	99	23	6.0
Continuous Power				
100	254	341	64	16.6

Cummins G-Drive Engines

Asia Pacific

10 Toh Guan Road
#07-01
TT International Tradepark
Singapore 608838
Phone 65 6417 2388
Fax 65 6417 2399

Europe, CIS, Middle

East and Africa
Manston Park Columbus Ave
Manston Ramsgate
Kent CT12 5BF. UK
Phone 44 1843 255000
Fax 44 1843 255902

Latin America

Rua Jati, 310, Cumbica
Guarulhos, SP 07180-900
Brazil
Phone 55 11 2186 4552
Fax 55 11 2186 4729

Mexico

Cummins S. de R.L. de C.V.
Eje 122 No. 200 Zona Industrial
San Luis Potosí, S.L.P. 78090
Mexico
Phone 52 444 870 6700
Fax 52 444 870 6811

North America

1400 73rd Avenue N.E.
Minneapolis, MN 55432
USA
Phone 1 763 574 5000
USA Toll-free 1 877 769 7669
Fax 1 763 574 5298

Ratings Definitions

Emergency Standby Power (ESP):

Applicable for supplying power to varying electrical load for the duration of power interruption of a reliable utility source. Emergency Standby Power (ESP) is in accordance with ISO 8528. Fuel Stop power in accordance with ISO 3046, AS 2789, DIN 6271 and BS 5514.

Limited-Time Running Power (LTP):

Applicable for supplying power to a constant electrical load for limited hours. Limited-Time Running Power (LTP) is in accordance with ISO 8528.

Prime Power (PRP):

Applicable for supplying power to varying electrical load for unlimited hours. Prime Power (PRP) is in accordance with ISO 8528. Ten percent overload capability is available in accordance with ISO 3046, AS 2789, DIN 6271 and BS 5514.

Base Load (Continuous) Power (COP):

Applicable for supplying power continuously to a constant electrical load for unlimited hours. Continuous Power (COP) in accordance with ISO 8528, ISO 3046, AS 2789, DIN6271 and BS 5514.

STAMFORD®

HCI 434E/444E - Technical Data Sheet

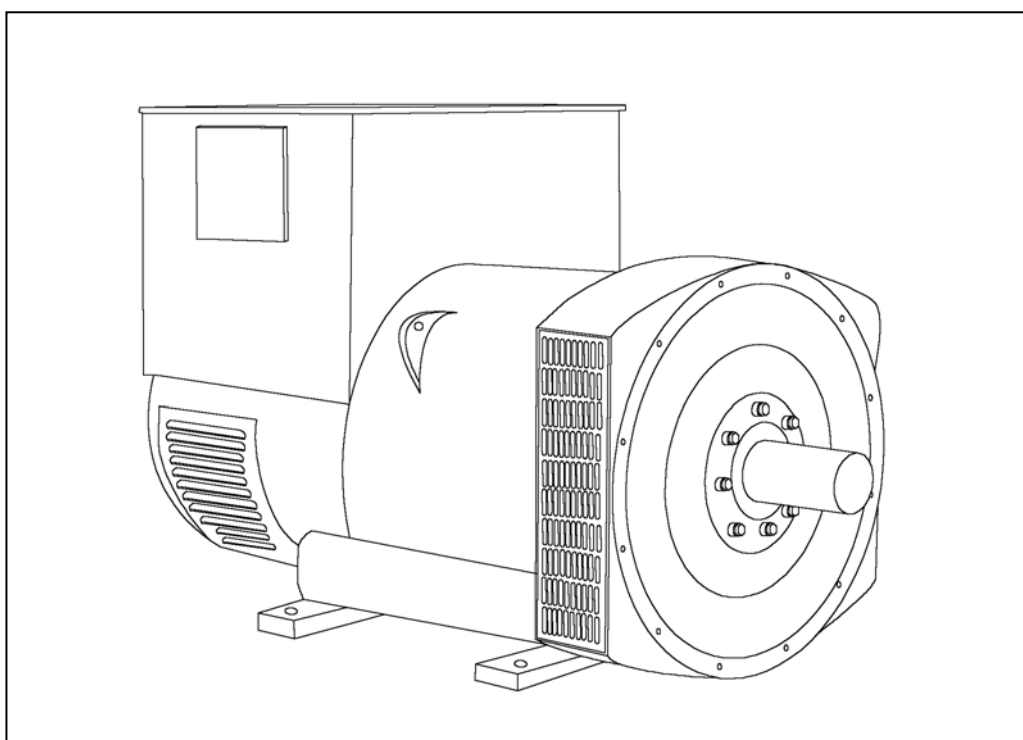

HCI434E/444E

SPECIFICATIONS & OPTIONS

STAMFORD

STANDARDS

Newage Stamford industrial generators meet the requirements of BS EN 60034 and the relevant section of other international standards such as BS5000, VDE 0530, NEMA MG1-32, IEC34, CSA C22.2-100, AS1359. Other standards and certifications can be considered on request.

VOLTAGE REGULATORS

AS440 AVR - STANDARD

With this self-excited system the main stator provides power via the Automatic Voltage Regulator (AVR) to the exciter stator. The high efficiency semi-conductors of the AVR ensure positive build-up from initial low levels of residual voltage.

The exciter rotor output is fed to the main rotor through a three-phase full-wave bridge rectifier. The rectifier is protected by a surge suppressor against surges caused, for example, by short circuit or out-of-phase paralleling.

The AS440 will support a range of electronic accessories, including a 'droop' Current Transformer (CT) to permit parallel operation with other ac generators.

MX341 AVR

This sophisticated AVR is incorporated into the Stamford Permanent Magnet Generator (PMG) control system.

The PMG provides power via the AVR to the main exciter, giving a source of constant excitation power independent of generator output. The main exciter output is then fed to the main rotor, through a full wave bridge, protected by a surge suppressor. The AVR has in-built protection against sustained over-excitation, caused by internal or external faults. This de-excites the machine after a minimum of 5 seconds.

An engine relief load acceptance feature can enable full load to be applied to the generator in a single step.

If three-phase sensing is required with the PMG system the MX321 AVR must be used.

We recommend three-phase sensing for applications with greatly unbalanced or highly non-linear loads.

MX321 AVR

The most sophisticated of all our AVRs combines all the features of the MX341 with, additionally, three-phase rms sensing, for improved regulation and performance. Over voltage protection is built-in and short circuit current level adjustments is an optional facility.

WINDINGS & ELECTRICAL PERFORMANCE

All generator stators are wound to 2/3 pitch. This eliminates triplen (3rd, 9th, 15th ...) harmonics on the voltage waveform and is found to be the optimum design for trouble-free supply of non-linear loads. The 2/3 pitch design avoids excessive neutral currents sometimes seen with higher winding pitches, when in parallel with the mains. A fully connected damper winding reduces oscillations during paralleling. This winding, with the 2/3 pitch and carefully selected pole and tooth designs, ensures very low waveform distortion.

TERMINALS & TERMINAL BOX

Standard generators are 3-phase reconnectable with 12 ends brought out to the terminals, which are mounted on a cover at the non-drive end of the generator. A sheet steel terminal box contains the AVR and provides ample space for the customers' wiring and gland arrangements. It has removable panels for easy access.

SHAFT & KEYS

All generator rotors are dynamically balanced to better than BS6861:Part 1 Grade 2.5 for minimum vibration in operation. Two bearing generators are balanced with a half key.

INSULATION/IMPREGNATION

The insulation system is class 'H'.

All wound components are impregnated with materials and processes designed specifically to provide the high build required for static windings and the high mechanical strength required for rotating components.

QUALITY ASSURANCE

Generators are manufactured using production procedures having a quality assurance level to BS EN ISO 9001.

The stated voltage regulation may not be maintained in the presence of certain radio transmitted signals. Any change in performance will fall within the limits of Criteria 'B' of EN 61000-6-2:2001. At no time will the steady-state voltage regulation exceed 2%.

NB Continuous development of our products entitles us to change specification details without notice, therefore they must not be regarded as binding.

Front cover drawing typical of product range.

HCI434E/444E



WINDING 311

CONTROL SYSTEM	SEPARATELY EXCITED BY P.M.G.							
A.V.R.	MX321	MX341						
VOLTAGE REGULATION	± 0.5 %	± 1.0 %	With 4% ENGINE GOVERNING					
SUSTAINED SHORT CIRCUIT	REFER TO SHORT CIRCUIT DECREMENT CURVES (page 7)							
CONTROL SYSTEM	SELF EXCITED							
A.V.R.	AS440							
VOLTAGE REGULATION	± 1.0 %	With 4% ENGINE GOVERNING						
SUSTAINED SHORT CIRCUIT	WILL NOT SUSTAIN A SHORT CIRCUIT							
INSULATION SYSTEM	CLASS H							
PROTECTION	IP23							
RATED POWER FACTOR	0.8							
STATOR WINDING	DOUBLE LAYER LAP							
WINDING PITCH	TWO THIRDS							
WINDING LEADS	12							
STATOR WDG. RESISTANCE	0.009 Ohms PER PHASE AT 22°C SERIES STAR CONNECTED							
ROTOR WDG. RESISTANCE	1.19 Ohms at 22°C							
EXCITER STATOR RESISTANCE	18 Ohms at 22°C							
EXCITER ROTOR RESISTANCE	0.068 Ohms PER PHASE AT 22°C							
R.F.I. SUPPRESSION	BS EN 61000-6-2 & BS EN 61000-6-4, VDE 0875G, VDE 0875N. refer to factory for others							
WAVEFORM DISTORTION	NO LOAD < 1.5% NON-DISTORTING BALANCED LINEAR LOAD < 5.0%							
MAXIMUM OVERSPEED	2250 Rev/Min							
BEARING DRIVE END	BALL. 6317 (ISO)							
BEARING NON-DRIVE END	BALL. 6314 (ISO)							
	1 BEARING				2 BEARING			
WEIGHT COMP. GENERATOR	1024 kg				1030 kg			
WEIGHT WOUND STATOR	470 kg				470 kg			
WEIGHT WOUND ROTOR	400 kg				377 kg			
WR ² INERTIA	4.6331 kgm ²				4.4343 kgm ²			
SHIPPING WEIGHTS in a crate	1095 kg				1100 kg			
PACKING CRATE SIZE	155 x 87 x 107(cm)				155 x 87 x 107(cm)			
	50 Hz				60 Hz			
TELEPHONE INTERFERENCE	THF<2%				TIF<50			
COOLING AIR	0.8 m ³ /sec 1700 cfm				0.99 m ³ /sec 2100 cfm			
VOLTAGE SERIES STAR	380/220	400/231	415/240	440/254	416/240	440/254	460/266	480/277
VOLTAGE PARALLEL STAR	190/110	200/115	208/120	220/127	208/120	220/127	230/133	240/138
VOLTAGE SERIES DELTA	220/110	230/115	240/120	254/127	240/120	254/127	266/133	277/138
KVA BASE RATING FOR REACTANCE VALUES	350	350	350	350	400	420	440	440
X _d DIR. AXIS SYNCHRONOUS	3.01	2.71	2.52	2.24	3.47	3.26	3.12	2.87
X' _d DIR. AXIS TRANSIENT	0.20	0.18	0.17	0.15	0.21	0.20	0.19	0.17
X'' _d DIR. AXIS SUBTRANSIENT	0.14	0.13	0.12	0.11	0.15	0.14	0.13	0.12
X _q QUAD. AXIS REACTANCE	2.58	2.33	2.16	1.92	2.92	2.74	2.63	2.41
X'' _q QUAD. AXIS SUBTRANSIENT	0.36	0.32	0.30	0.27	0.41	0.38	0.37	0.34
X _L LEAKAGE REACTANCE	0.07	0.06	0.06	0.05	0.08	0.08	0.07	0.07
X ₂ NEGATIVE SEQUENCE	0.24	0.22	0.20	0.18	0.28	0.26	0.25	0.23
X ₀ ZERO SEQUENCE	0.10	0.09	0.08	0.07	0.10	0.09	0.09	0.08
REACTANCES ARE SATURATED				VALUES ARE PER UNIT AT RATING AND VOLTAGE INDICATED				
T' _d TRANSIENT TIME CONST.	0.08s							
T'' _d SUB-TRANSTIME CONST.	0.019s							
T' _{do} O.C. FIELD TIME CONST.	1.7s							
T _a ARMATURE TIME CONST.	0.018s							
SHORT CIRCUIT RATIO	1/X _d							

50
Hz

HCI434E/444E

STAMFORD

Winding 311

THREE PHASE EFFICIENCY CURVES

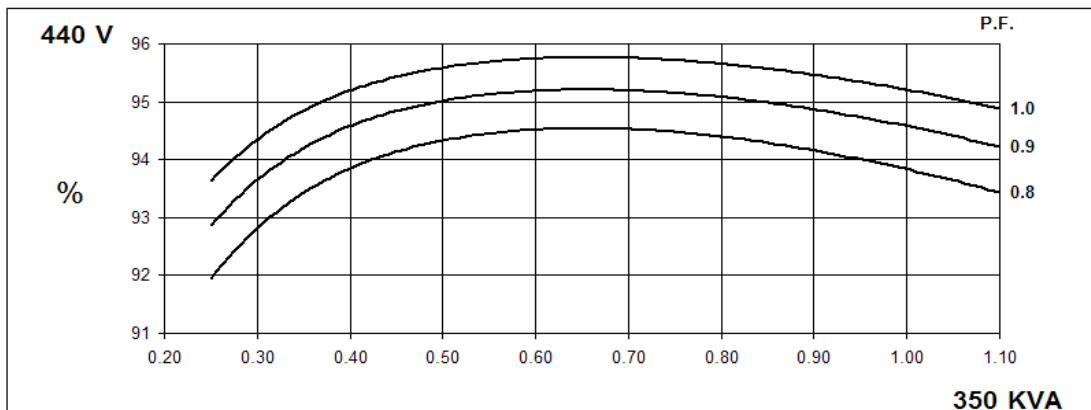
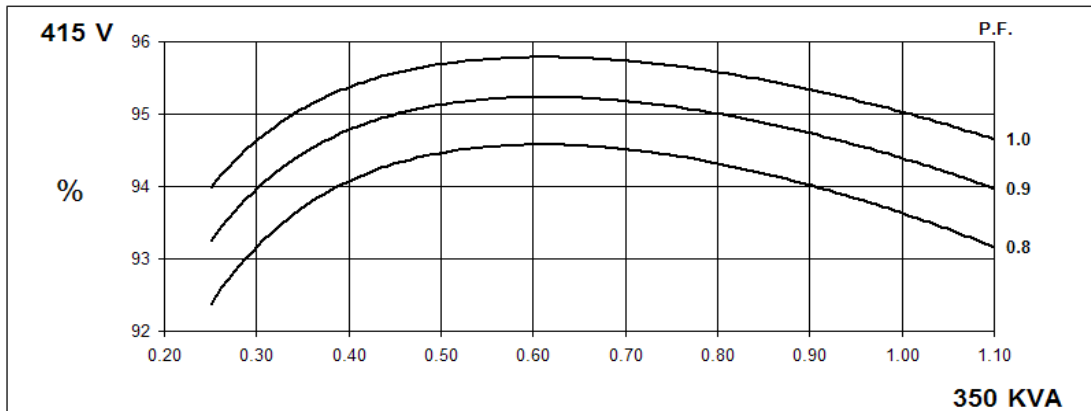
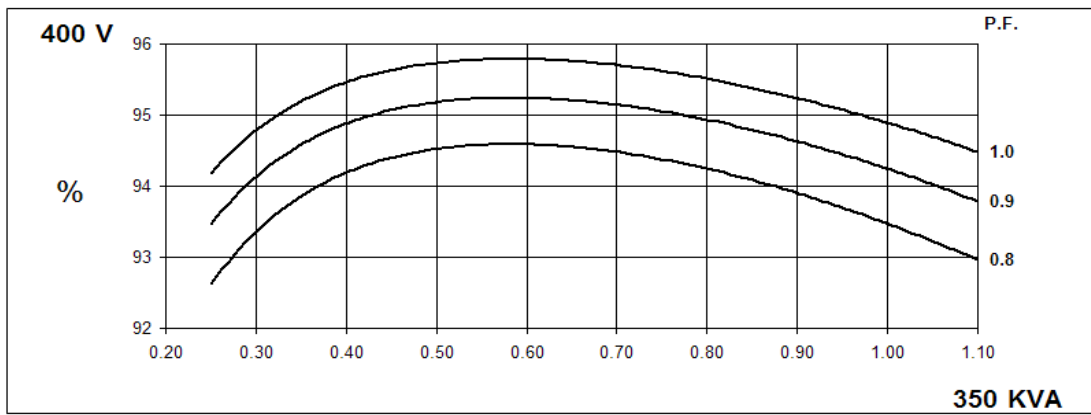
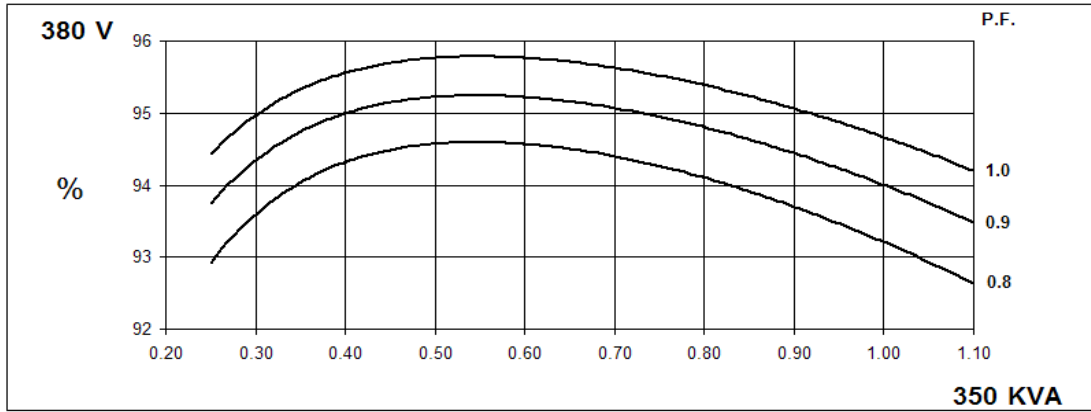

60
Hz

HCI434E/444E

STAMFORD

Winding 311

THREE PHASE EFFICIENCY CURVES

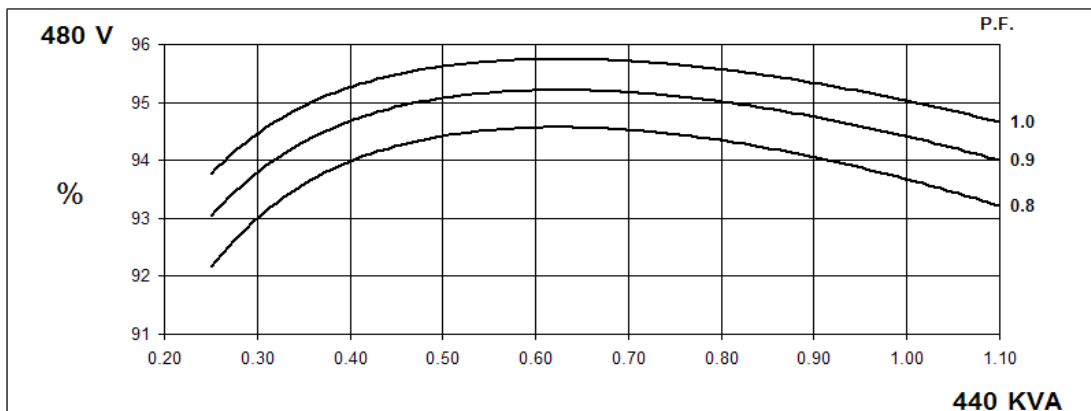
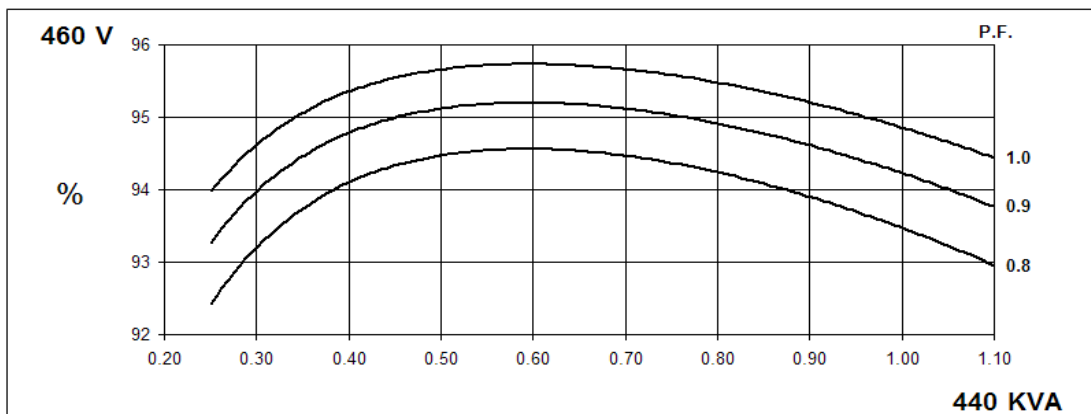
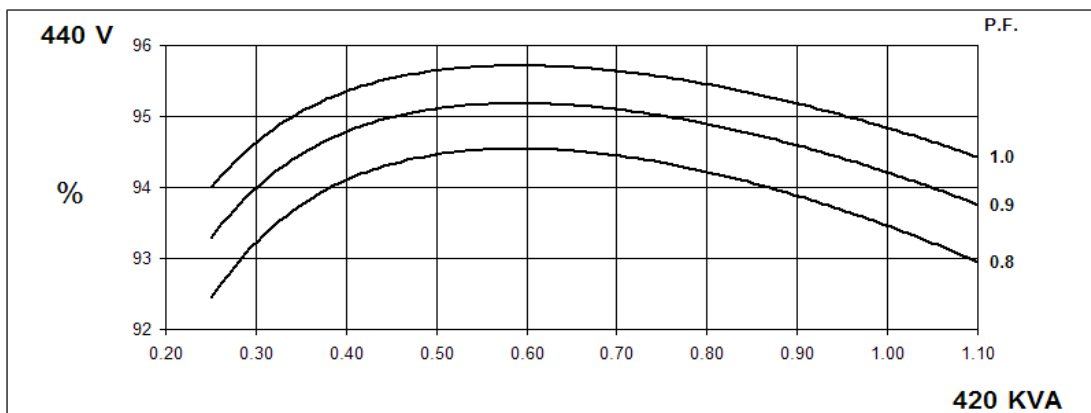
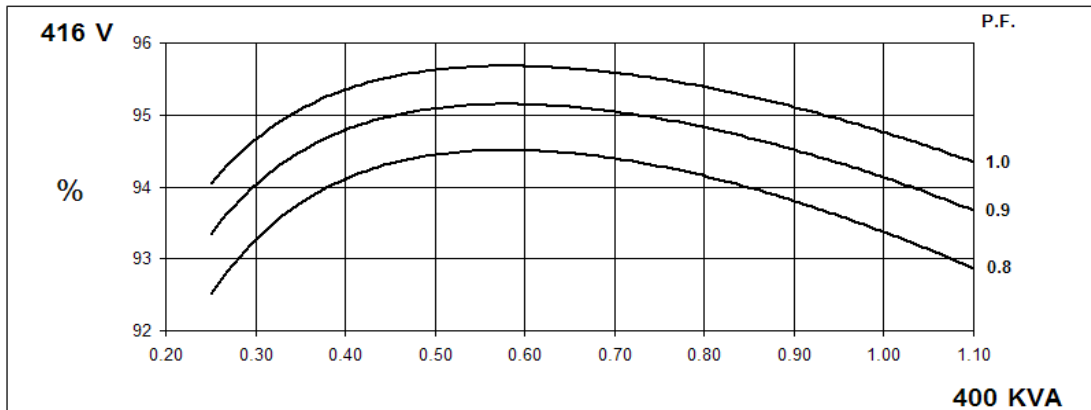

Locked Rotor Motor Starting Curve

50
Hz

MX



SX

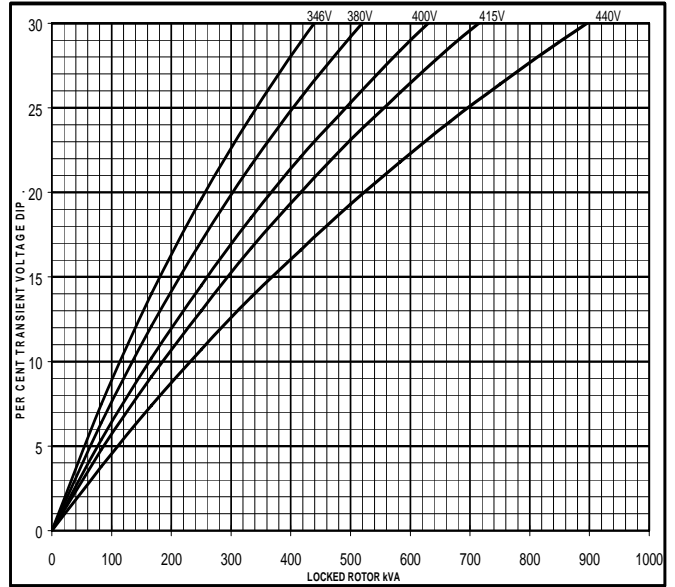

60
Hz

MX

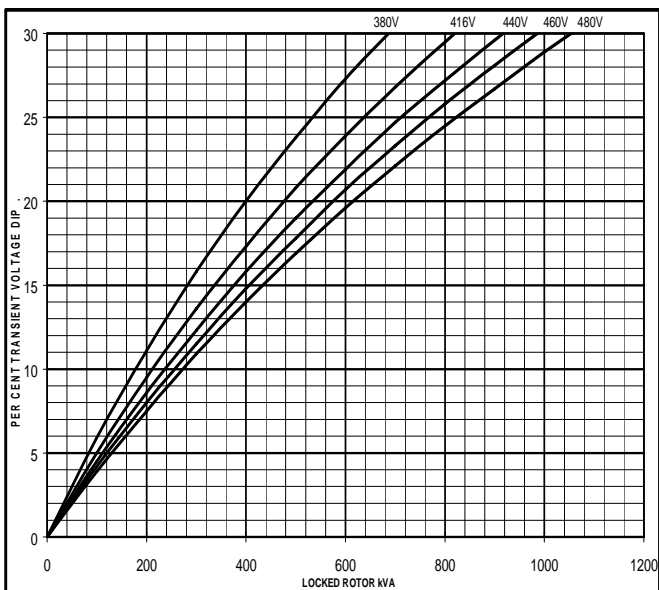

SX

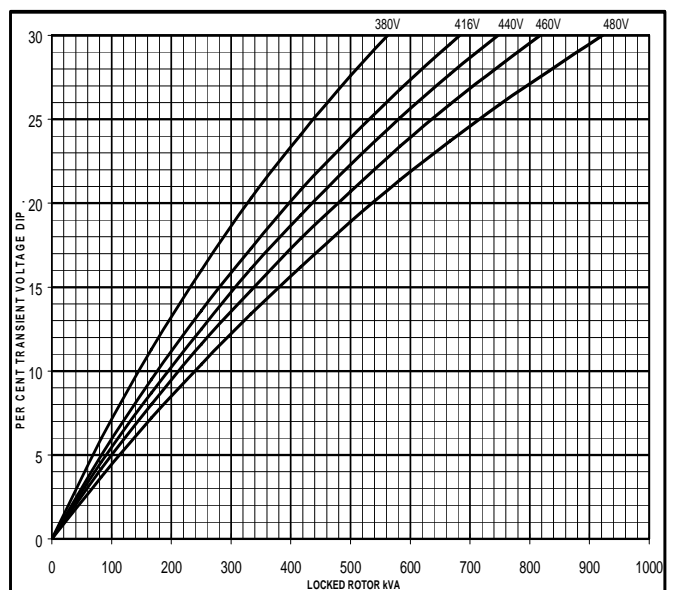

**Three-phase Short Circuit Decrement Curve. No-load Excitation at Rated Speed
Based on star (wye) connection.**

**50
Hz**

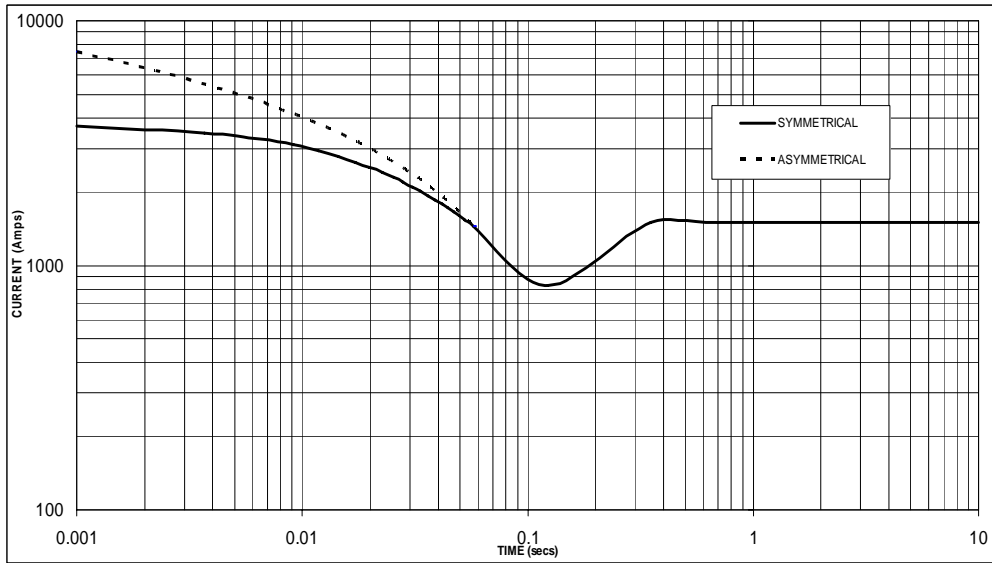

Sustained Short Circuit = 1,500 Amps

**60
Hz**

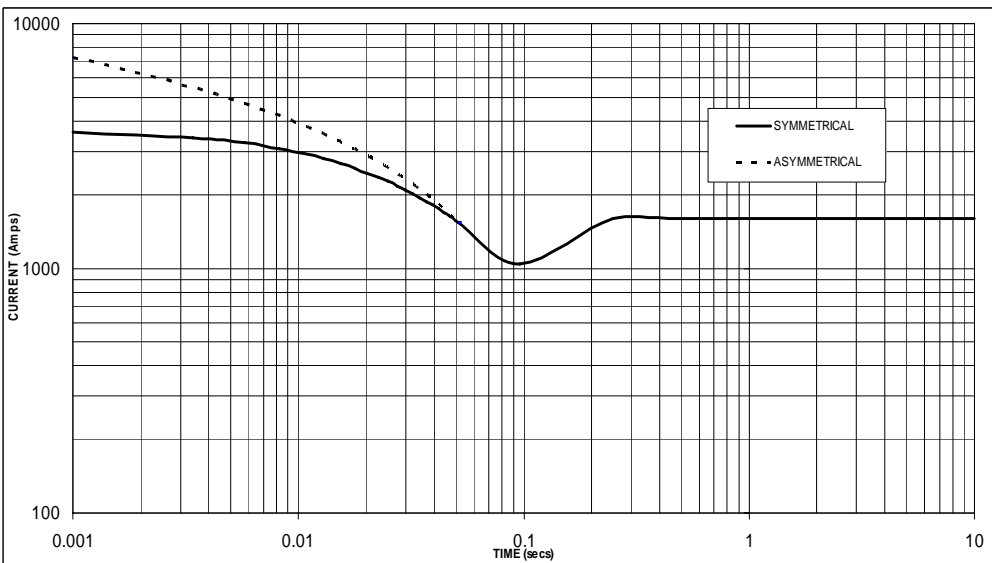

Sustained Short Circuit = 1,600 Amps

Note 1

The following multiplication factors should be used to adjust the values from curve between time 0.001 seconds and the minimum current point in respect of nominal operating voltage :

50Hz		60Hz	
Voltage	Factor	Voltage	Factor
380v	X 1.00	416v	X 1.00
400v	X 1.05	440v	X 1.06
415v	X 1.10	460v	X 1.10
440v	X 1.16	480v	X 1.15

The sustained current value is constant irrespective of voltage level

Note 2

The following multiplication factor should be used to convert the values calculated in accordance with NOTE 1 to those applicable to the various types of short circuit :

	3-phase	2-phase L-L	1-phase L-N
Instantaneous	x 1.00	x 0.87	x 1.30
Minimum	x 1.00	x 1.80	x 3.20
Sustained	x 1.00	x 1.50	x 2.50
Max. sustained duration	10 sec.	5 sec.	2 sec.

All other times are unchanged

Note 3

Curves are drawn for Star (Wye) connected machines. For other connection the following multipliers should be applied to current values as shown :

HCI434E/444E

Winding 311 / 0.8 Power Factor

STAMFORD

RATINGS

Class - Temp Rise	Cont. F - 105/40°C				Cont. H - 125/40°C				Standby - 150/40°C				Standby - 163/27°C				
50 Hz	Series Star (V)	380	400	415	440	380	400	415	440	380	400	415	440	380	400	415	440
	Parallel Star (V)	190	200	208	220	190	200	208	220	190	200	208	220	190	200	208	220
	Series Delta (V)	220	230	240	254	220	230	240	254	220	230	240	254	220	230	240	254
kVA	320	320	320	320	350	350	350	350	370	370	370	370	380	400	380	380	
kW	256	256	256	256	280	280	280	280	296	296	296	296	304	320	304	304	
Efficiency (%)	93.6	93.8	94.0	94.1	93.2	93.5	93.6	93.8	92.9	93.2	93.4	93.6	92.7	92.7	93.2	93.5	
kW Input	274	273	272	272	300	299	299	299	319	318	317	316	328	345	326	325	

60 Hz	Series Star (V)	416	440	460	480	416	440	460	480	416	440	460	480	416	440	460	480
	Parallel Star (V)	208	220	230	240	208	220	230	240	208	220	230	240	208	220	230	240
	Series Delta (V)	240	254	266	277	240	254	266	277	240	254	266	277	240	254	266	277
kVA	365	385	400	400	400	420	440	440	420	445	460	460	435	455	475	475	
kW	292	308	320	320	320	336	352	352	336	356	368	368	348	364	380	380	
Efficiency (%)	93.8	93.8	93.9	94.0	93.4	93.5	93.5	93.7	93.1	93.2	93.2	93.5	92.9	93.0	93.1	93.3	
kW Input	311	328	341	340	343	359	376	376	361	382	395	394	375	391	408	407	

DIMENSIONS

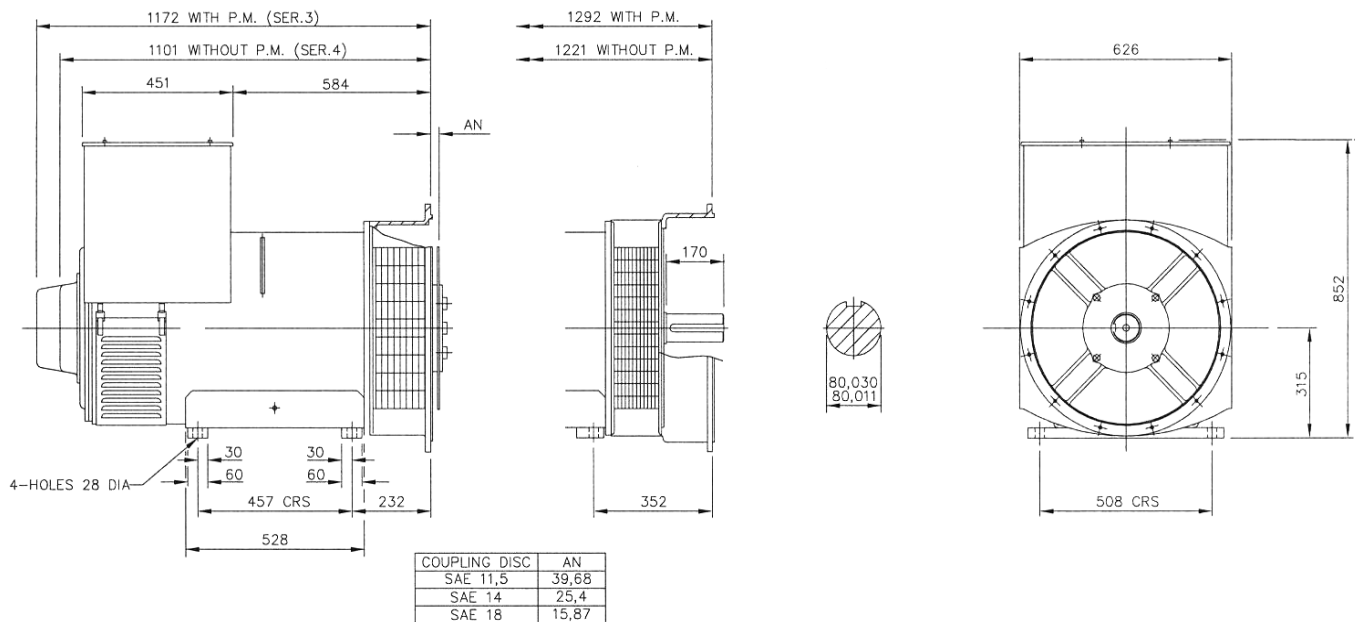

STAMFORD

Barnack Road • Stamford • Lincolnshire • PE9 2NB
Tel: 00 44 (0)1780 484000 • Fax: 00 44 (0)1780 484100



Specification sheet

KTA50-G8



Description

The KTA50-Series benefits from years of technical development and improvement to bring customers an innovative and future proof diesel engine that keeps pace with ever changing generator set requirements.

Recognised globally for its performance under even the most severe climatic conditions, the KTA50-Series is widely acknowledged as the most robust and cost-effective diesel engine in its power range for the generator set market.

Features

Coolpac Integrated Design - Products are supplied complete with cooling package and air cleaner kit for a complete power package. Each component has been specifically developed and rigorously tested for G-Drive products, ensuring high performance, durability and reliability.

Aftercooler – Large capacity integral aftercoolers are supplied with cooling water separate from the engine jacket. This provides cooler, denser intake air for more complete combustion and reduced engine stresses for longer life and low exhaust emissions.

Cooling System – A two pump, two loop system must be employed; i.e. the engine jacket is cooled by one radiator or heat exchanger and the aftercoolers are cooled by a separate radiator or heat exchanger.

Pistons – Pistons are dual Ni-resist, aluminium alloy, ground and shaped to compensate for thermal expansion, which assures a precise fit at all normal operating temperatures.

Service and Support - G-Drive products are backed by an uncompromising level of technical support and after sales service, delivered through a world class service network.

Codes and standards



This engine has been built to comply with CE certification.



This engine has been designed in facilities certified to ISO9001 and manufactured in facilities certified to ISO9001 or ISO9002.

1500 rpm (50 Hz Ratings)

Gross Engine Output			Net Engine Output			Typical Generator Set Output					
Standby	Prime	Base	Standby	Prime	Base	Standby (ESP)		Prime (PRP)		Base (COP)	
kWm/BHP			kWm/BHP			kWe	kVA	kWe	kVA	kWe	kVA
1429/1915	1200/1608	1100/1475	1397/1872	1168/1566	1068/1432	1340	1675	1120	1400	1025	1282

General Engine Data

Type	4 cycle, 60° Vee, Turbocharged and Aftercooled
Bore, mm	159
Stroke, mm	159
Displacement, Litre	50.3
Cylinder Block	16-cylinder, direct injection, 4-cycle diesel engine
Battery Charging Alternator	35A
Starting Voltage	24V
Fuel System	Direct injection Cummins PT
Fuel Filter	Dual spin on paper element fuel filters with standard water separator
Lube Oil Filter Type(s)	Spin on full flow filter
Lube Oil Capacity (l)	178
Flywheel Dimensions	SAE #0

Coolpac Performance Data

Cooling System Design	2 pump - 2 loop
Coolant Ratio	50% ethylene glycol; 50% water
Coolant Capacity (l)	496
Limiting Ambient Temp.(°C)**	48
Fan Power (kWm)	32
Cooling system air flow (m ³ /s)**	28.8
Air Cleaner Type	Dry replaceable element with restriction indicator

** @13 mm H₂O

Weight and Dimensions

Length	Width	Height	Weight (dry)
mm	mm	mm	kg
3720	2000	2516	6580

Fuel Consumption 1500 (50 Hz)

%	kWm	BHP	L/hr	US gal/hr
Standby Power				
100	1429	1915	345	91.2
Prime Power				
100	1200	1608	289	76.3
75	900	1206	222	58.7
50	600	804	155	40.9
25	300	402	82	21.7
Continuous Power				
100	1100	1475	266	70.4

Ratings Definitions

Emergency Standby Power (ESP):

Applicable for supplying power to varying electrical load for the duration of power interruption of a reliable utility source. Emergency Standby Power (ESP) is in accordance with ISO 8528. Fuel Stop power in accordance with ISO 3046, AS 2789, DIN 6271 and BS 5514.

Limited-Time Running Power (LTP):

Applicable for supplying power to a constant electrical load for limited hours. Limited-Time Running Power (LTP) is in accordance with ISO 8528.

Prime Power (PRP):

Applicable for supplying power to varying electrical load for unlimited hours. Prime Power (PRP) is in accordance with ISO 8528. Ten percent overload capability is available in accordance with ISO 3046, AS 2789, DIN 6271 and BS 5514.

Base Load (Continuous) Power (COP):

Applicable for supplying power continuously to a constant electrical load for unlimited hours. Continuous Power (COP) is in accordance with ISO 8528, ISO 3046, AS 2789, DIN6271 and BS 5514.

Cummins G-Drive Engines

Asia Pacific
10 Toh Guan Road
#07-01
TT International Tradepark
Singapore 608838
Phone 65 6417 2388
Fax 65 6417 2399

Europe, CIS, Middle East and Africa
Manston Park Columbus Ave
Manston Ramsgate
Kent CT12 5BF. UK
Phone 44 1843 255000
Fax 44 1843 255902

Latin America
Rua Jati, 310, Cumbica
Guarulhos, SP 07180-900
Brazil
Phone 55 11 2186 4552
Fax 55 11 2186 4729

Mexico
Cummins S. de R.L. de C.V.
Eje 122 No. 200 Zona Industrial
San Luis Potosí, S.L.P. 78090
Mexico
Phone 52 444 870 6700
Fax 52 444 870 6811

North America
1400 73rd Avenue N.E.
Minneapolis, MN 55432
USA
Phone 1 763 574 5000
Toll-free 1 877 769 7669
Fax 1 763 574 5298



PI734B - Technical Data Sheet

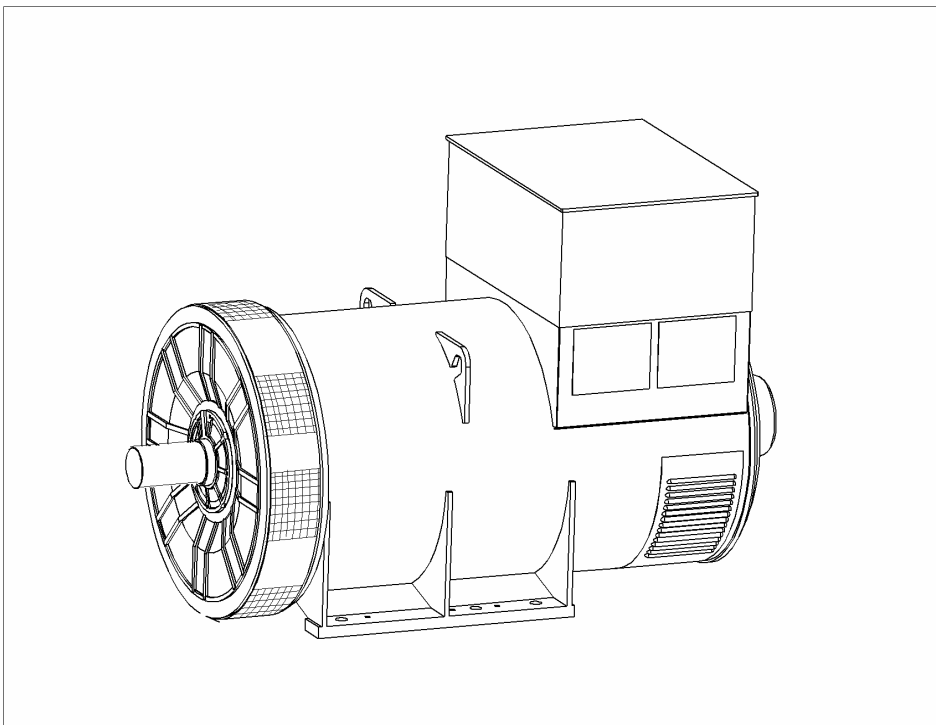

PI734B

SPECIFICATIONS & OPTIONS



STANDARDS

Newage Stamford industrial generators meet the requirements of BS EN 60034 and the relevant sections of other national and international standards such as BS5000, VDE 0530, NEMA MG1-32, IEC60034, CSA C22.2-100, AS1359.

Other standards and certifications can be considered on request.

DESCRIPTION

The STAMFORD PI range of synchronous ac generators are brushless with a rotating field. They are separately excited by the STAMFORD Permanent Magnet Generator (PMG). This is a shaft mounted, high frequency, pilot exciter which provides a constant supply of clean power via the Automatic Voltage Regulator (AVR) to the main exciter. The main exciter output is fed to the main rotor, through a full wave bridge rectifier, protected by surge suppression.

VOLTAGE REGULATORS

The PI range generators, complete with a PMG, are available with one of two AVRs. Each AVR has soft start voltage build up and built in protection against sustained over-excitation, which will de-excite the generator after a minimum of 8 seconds.

Underspeed protection (UFRO) is also provided on both AVRs. The UFRO will reduce the generator output voltage proportional to the speed of the generator below a pre-settable level.

The **MX341 AVR** is two phase sensed with a voltage regulation of $\pm 1\%$. (see the note on regulation).

The **MX321 AVR** is 3 phase rms sensed with a voltage regulation of 0.5% rms (see the note on regulation). The UFRO circuit has adjustable slope and dwell for controlled recovery from step loads. An over voltage protection circuit will shutdown the output device of the AVR, it can also trip an optional excitation circuit breaker if required. As an option, short circuit current limiting is available with the addition of current transformers.

Both the MX341 and the MX321 need a generator mounted current transformer to provide quadrature droop characteristics for load sharing during parallel operation. Provision is also made for the connection of the STAMFORD power factor controller, for embedded applications, and a remote voltage trimmer.

WINDINGS & ELECTRICAL PERFORMANCE

All generator stators are wound to 2/3 pitch. This eliminates triplen (3rd, 9th, 15th ...) harmonics on the voltage waveform and is found to be the optimum design for trouble-free supply of non-linear loads. The 2/3 pitch design avoids excessive neutral currents sometimes seen with higher winding pitches. A fully connected damper winding reduces oscillations during paralleling. This winding, with the 2/3 pitch and carefully selected pole and tooth designs, ensures very low levels of voltage waveform distortion.

TERMINALS & TERMINAL BOX

Standard generators feature a main stator with 6 ends brought out to the terminals, which are mounted on the frame at the non-drive end of the generator. A sheet steel terminal box contains the AVR and provides ample space for the customers' wiring and gland arrangements. It has removable panels for easy access.

SHAFT & KEYS

All generator rotors are dynamically balanced to better than BS6861:Part 1 Grade 2.5 for minimum vibration in operation. Two bearing generators are balanced with a half key.

INSULATION/IMPREGNATION

The insulation system is class 'H', and meets the requirements of UL1446.

All wound components are impregnated with materials and processes designed specifically to provide the high build required for static windings and the high mechanical strength required for rotating components.

QUALITY ASSURANCE

Generators are manufactured using production procedures having a quality assurance level to BS EN ISO 9001.

NOTE ON REGULATION

The stated voltage regulation may not be maintained in the presence of certain radio transmitted signals. Any change in performance will fall within the limits of Criteria 'B' of EN 61000-6-2:2001. At no time will the steady-state voltage regulation exceed 2%.

Note: Continuous development of our products entitles us to change specification details without notice, therefore they must not be regarded as binding.

Front cover drawing is typical of the product range.

PI734B
WINDING 312

CONTROL SYSTEM	SEPARATELY EXCITED BY P.M.G.		
A.V.R.	MX341	MX321	
VOLTAGE REGULATION	± 1%	± 0.5 %	With 4% ENGINE GOVERNING
SUSTAINED SHORT CIRCUIT	REFER TO SHORT CIRCUIT DECREMENT CURVES (page 7)		

INSULATION SYSTEM	CLASS H
PROTECTION	IP23
RATED POWER FACTOR	0.8
STATOR WINDING	DOUBLE LAYER LAP
WINDING PITCH	TWO THIRDS
WINDING LEADS	6
MAIN STATOR RESISTANCE	0.0016 Ohms PER PHASE AT 22°C STAR CONNECTED
MAIN ROTOR RESISTANCE	1.67 Ohms at 22°C
EXCITER STATOR RESISTANCE	17.5 Ohms at 22°C
EXCITER ROTOR RESISTANCE	0.048 Ohms PER PHASE AT 22°C
R.F.I. SUPPRESSION	BS EN 61000-6-2 & BS EN 61000-6-4, VDE 0875G, VDE 0875N. refer to factory for others
WAVEFORM DISTORTION	NO LOAD < 1.5% NON-DISTORTING BALANCED LINEAR LOAD < 5.0%
MAXIMUM OVERSPEED	2250 Rev/Min
BEARING DRIVE END	BALL. 6228 C3
BEARING NON-DRIVE END	BALL. 6319 C3

	1 BEARING	2 BEARING
WEIGHT COMP. GENERATOR	2760 kg	2710 kg
WEIGHT WOUND STATOR	1306 kg	1306 kg
WEIGHT WOUND ROTOR	1139 kg	1077 kg
WR ² INERTIA	32.7498 kgm ²	31.7489 kgm ²
SHIPPING WEIGHTS in a crate	2833kg	2779kg
PACKING CRATE SIZE	194 x 105 x 154(cm)	194 x 105 x 154(cm)

	50 Hz				60 Hz			
TELEPHONE INTERFERENCE	THF<2%				TIF<50			
COOLING AIR	2.69 m ³ /sec 5700 cfm				3.45 m ³ /sec 7300 cfm			
VOLTAGE STAR	380/220	400/231	415/240	440/254	416/240	440/254	460/266	480/277
KVA BASE RATING FOR REACTANCE VALUES	1360	1400	1400	1375	1525	1625	1655	1690
X _d DIR. AXIS SYNCHRONOUS	3.50	3.26	3.02	2.64	4.25	4.04	3.77	3.53
X' _d DIR. AXIS TRANSIENT	0.21	0.20	0.18	0.16	0.26	0.25	0.23	0.22
X'' _d DIR. AXIS SUBTRANSIENT	0.16	0.15	0.14	0.12	0.19	0.18	0.17	0.16
X _q QUAD. AXIS REACTANCE	2.26	2.10	1.95	1.70	2.74	2.61	2.43	2.28
X'' _q QUAD. AXIS SUBTRANSIENT	0.32	0.29	0.27	0.24	0.38	0.37	0.34	0.32
X _L LEAKAGE REACTANCE	0.04	0.04	0.03	0.03	0.05	0.05	0.04	0.04
X ₂ NEGATIVE SEQUENCE	0.22	0.21	0.19	0.17	0.27	0.26	0.24	0.23
X ₀ ZERO SEQUENCE	0.03	0.03	0.02	0.02	0.03	0.03	0.03	0.03

REACTANCES ARE SATURATED

VALUES ARE PER UNIT AT RATING AND VOLTAGE INDICATED

T' _d TRANSIENT TIME CONST.	0.13s
T'' _d SUB-TRANSTIME CONST.	0.01s
T' _{do} O.C. FIELD TIME CONST.	2.14s
T _a ARMATURE TIME CONST.	0.02s
SHORT CIRCUIT RATIO	1/X _d

**50
Hz**

PI734B
Winding 312



THREE PHASE EFFICIENCY CURVES

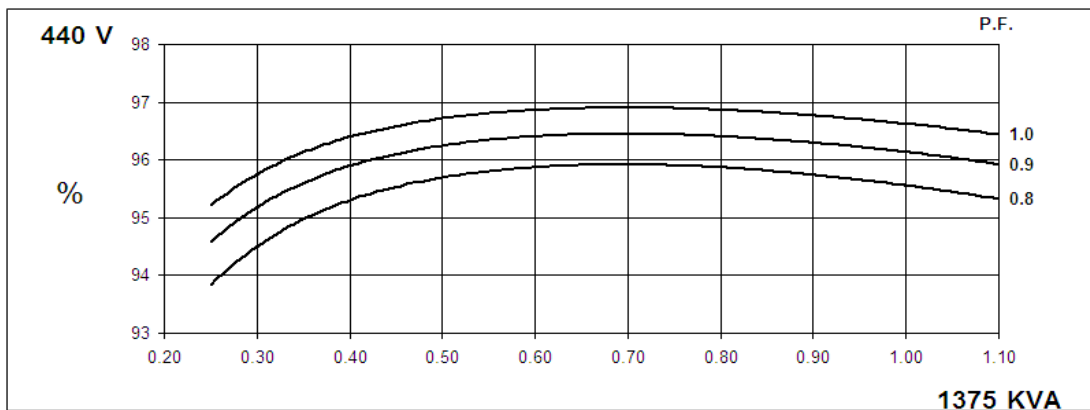
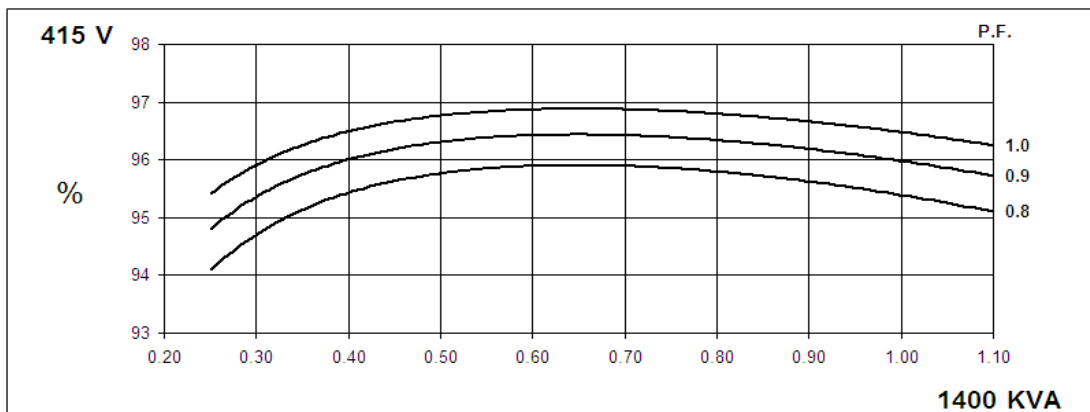
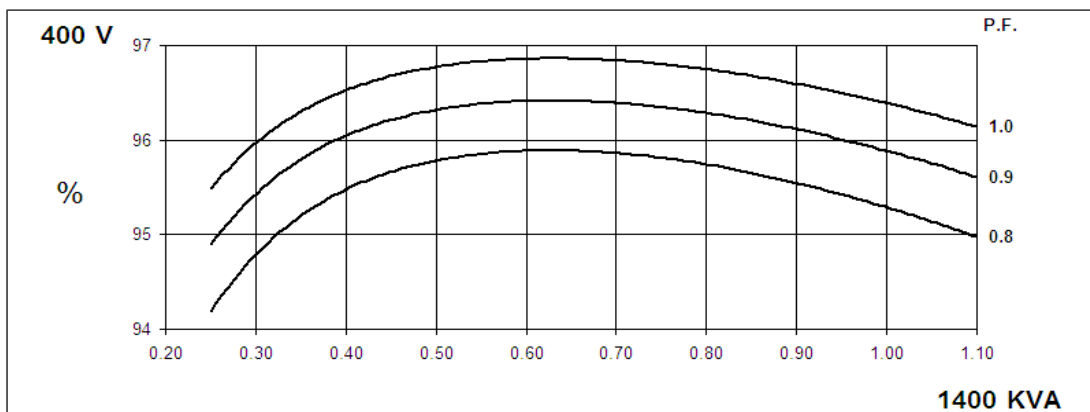
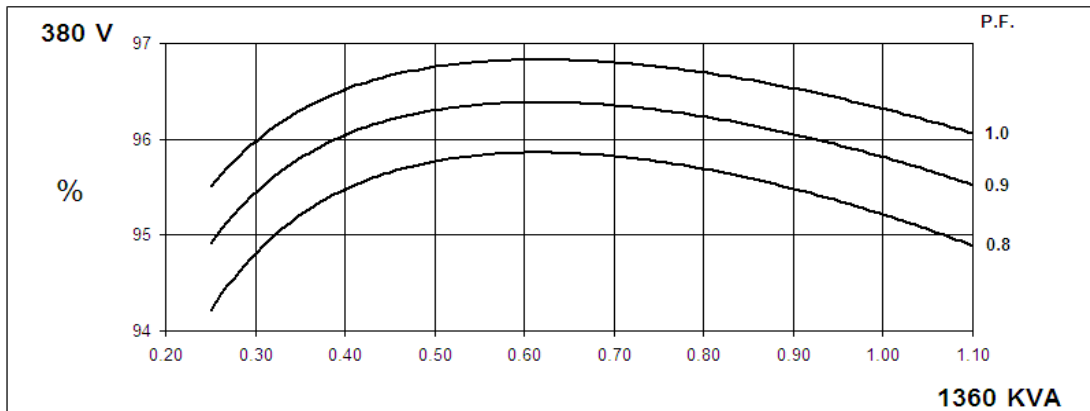

THREE PHASE EFFICIENCY CURVES

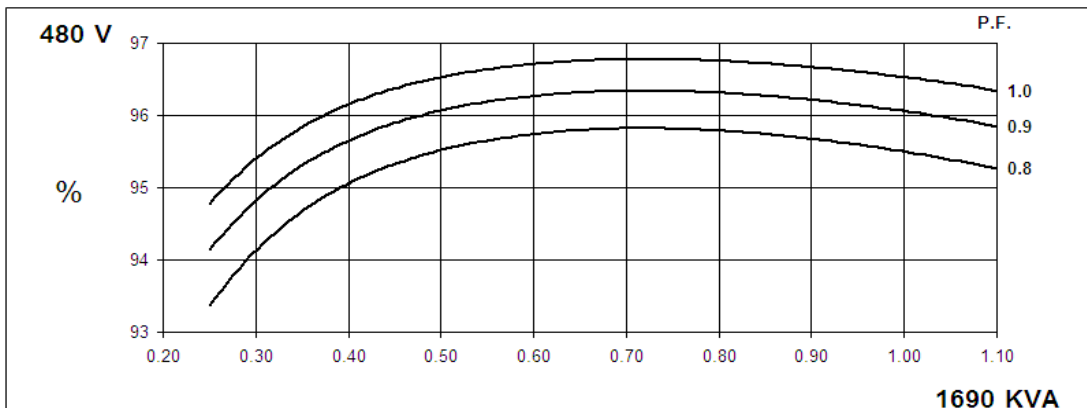
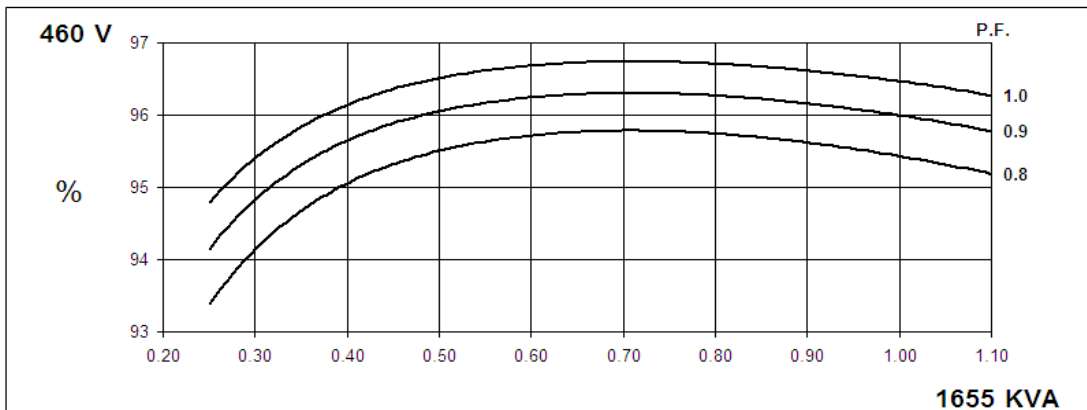
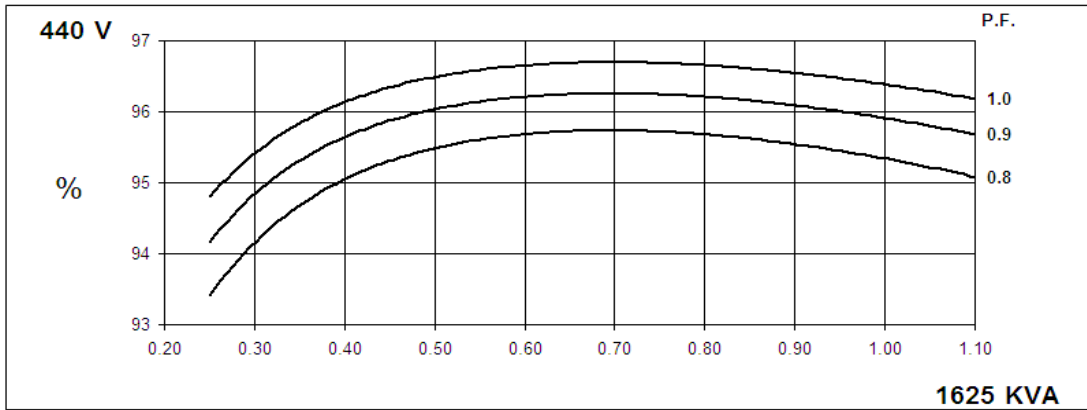
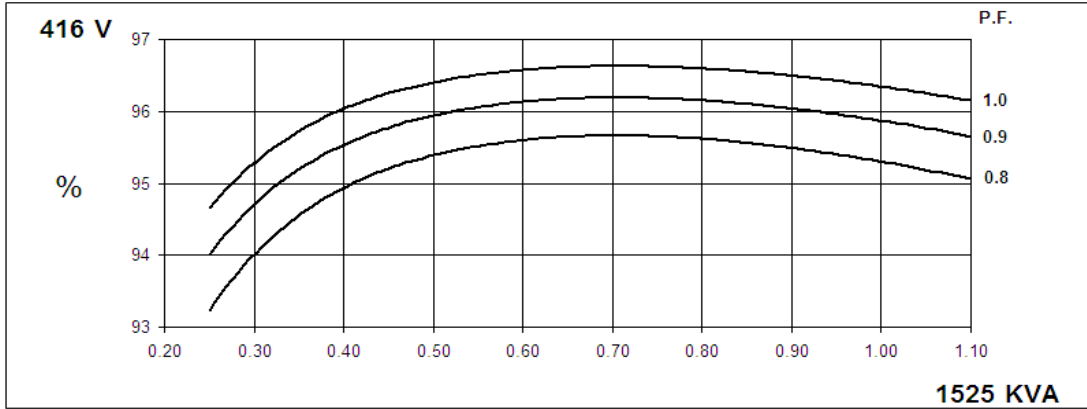

PI734B

Winding 312



Locked Rotor Motor Starting Curve

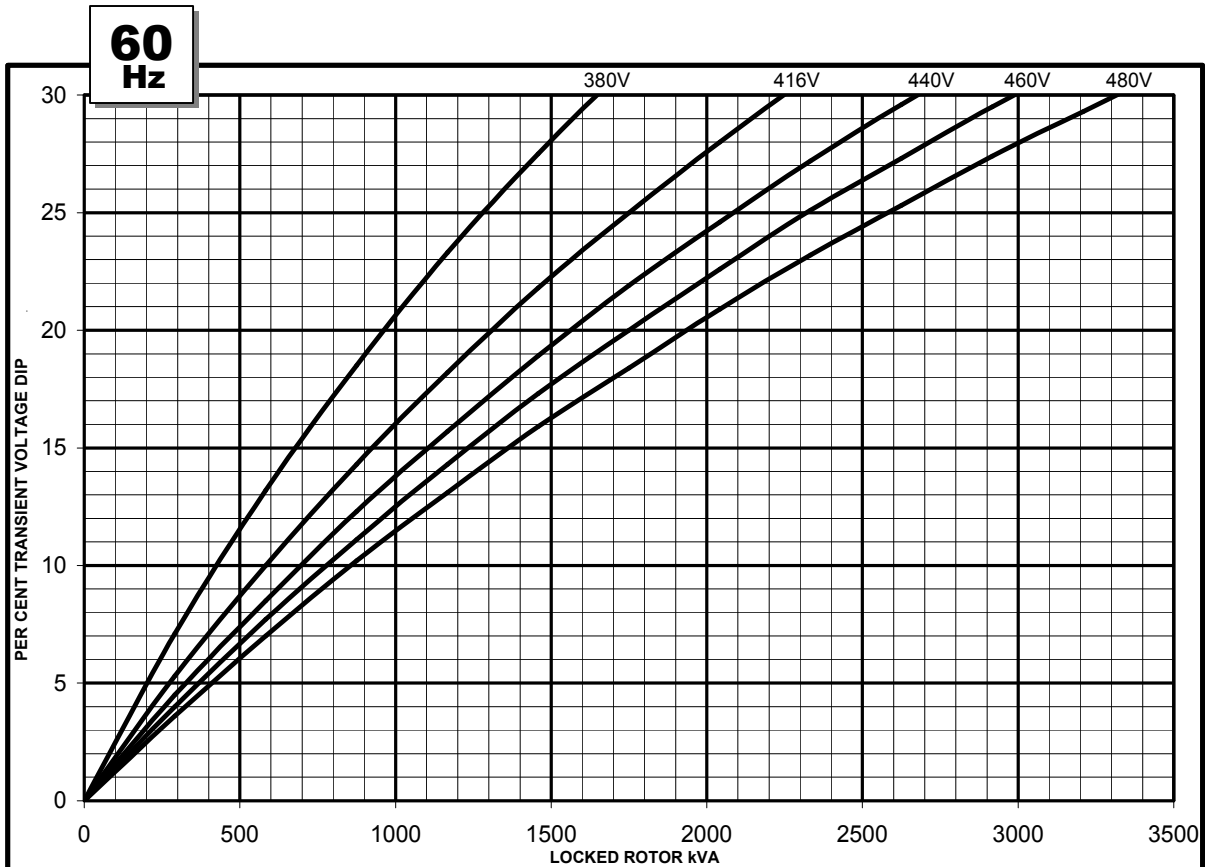
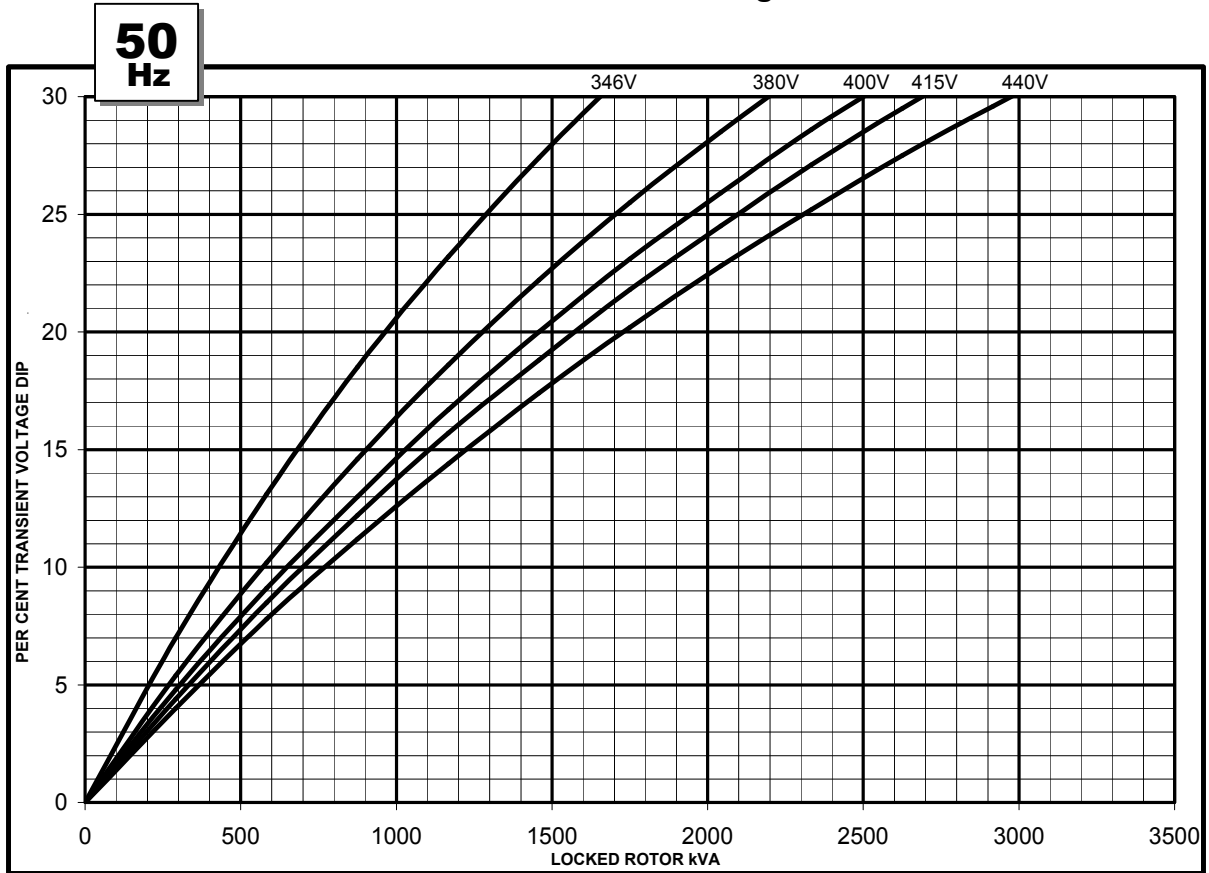

**Three-phase Short Circuit Decrement Curve. No-load Excitation at Rated Speed
Based on star (wye) connection.**

**50
Hz**

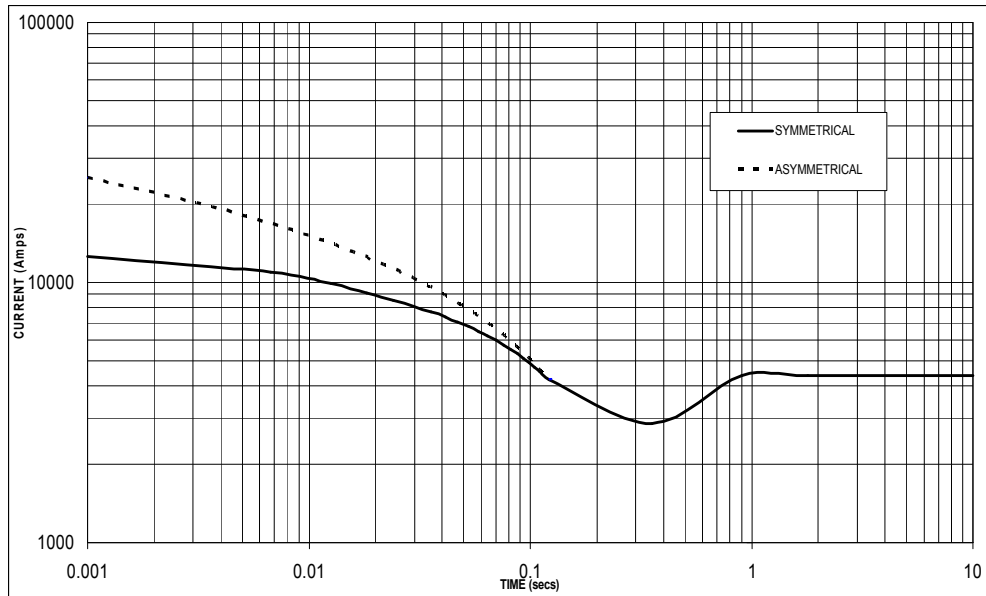

Sustained Short Circuit = 4,400 Amps

**60
Hz**

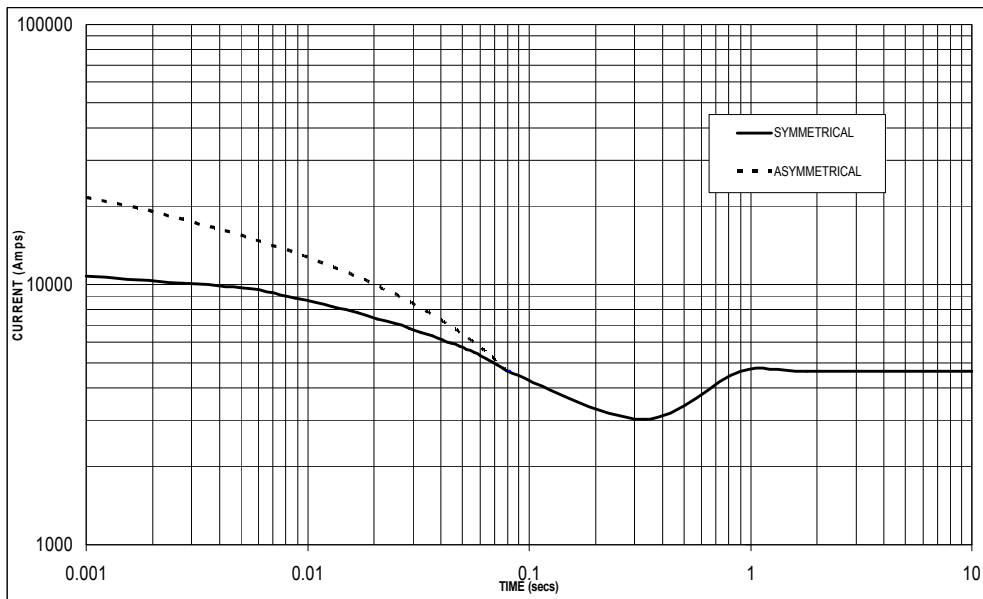

Sustained Short Circuit = 4,650 Amps

Note 1

The following multiplication factors should be used to adjust the values from curve between time 0.001 seconds and the minimum current point in respect of nominal operating voltage :

50Hz		60Hz	
Voltage	Factor	Voltage	Factor
380v	x 1.00	416v	x 1.00
400v	x 1.05	440v	x 1.06
415v	x 1.09	460v	x 1.10
440v	x 1.16	480v	x 1.15

The sustained current value is constant irrespective of voltage level

Note 2

The following multiplication factor should be used to convert the values calculated in accordance with NOTE 1 to those applicable to the various types of short circuit :

	3-phase	2-phase L-L	1-phase L-N
Instantaneous	x 1.00	x 0.87	x 1.30
Minimum	x 1.00	x 1.80	x 3.20
Sustained	x 1.00	x 1.50	x 2.50
Max. sustained duration	10 sec.	5 sec.	2 sec.

All other times are unchanged

Note 3

Curves are drawn for Star (Wye) connected machines.

PI734B

Winding 312 / 0.8 Power Factor



RATINGS

Class - Temp Rise		Cont. F - 105/40°C				Cont. H - 125/40°C				Standby - 150/40°C				Standby - 163/27°C			
50Hz	Star (V)	380	400	415	440	380	400	415	440	380	400	415	440	380	400	415	440
	kVA	1265	1305	1305	1280	1360	1400	1400	1375	1415	1460	1460	1430	1455	1500	1500	1470
	kW	1012	1044	1044	1024	1088	1120	1120	1100	1132	1168	1168	1144	1164	1200	1200	1176
	Efficiency (%)	95.4	95.5	95.6	95.7	95.2	95.3	95.4	95.6	95.1	95.2	95.3	95.5	95.0	95.1	95.2	95.4
	kW Input	1061	1093	1092	1070	1143	1175	1174	1151	1190	1227	1226	1198	1225	1262	1261	1233

60Hz	Star (V)	416	440	460	480	416	440	460	480	416	440	460	480	416	440	460	480
	kVA	1415	1510	1540	1575	1525	1625	1655	1690	1590	1690	1725	1760	1630	1740	1775	1810
	kW	1132	1208	1232	1260	1220	1300	1324	1352	1272	1352	1380	1408	1304	1392	1420	1448
	Efficiency (%)	95.4	95.5	95.6	95.6	95.3	95.3	95.4	95.5	95.2	95.2	95.3	95.4	95.1	95.2	95.3	95.3
	kW Input	1187	1265	1289	1318	1280	1364	1388	1416	1336	1420	1448	1476	1371	1462	1490	1519

DIMENSIONS

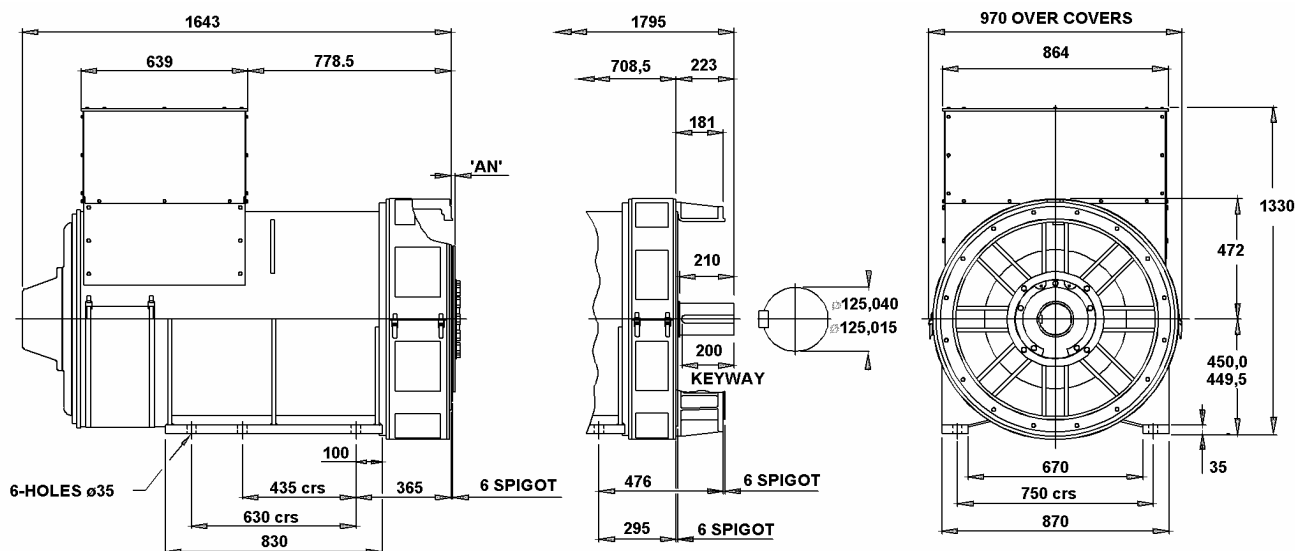

COUPLING DISC	'AN'
S.A.E No 18	15,7
S.A.E No 21	0
S.A.E No 24	0

1-BRG ADAPTORS
S.A.E No 0
S.A.E No 00

2-BRG ADAPTORS
S.A.E No 0
S.A.E No 00



Barnack Road • Stamford • Lincolnshire • PE9 2NB
Tel: 00 44 (0)1780 484000 • Fax: 00 44 (0)1780 484100

KTA50-G3

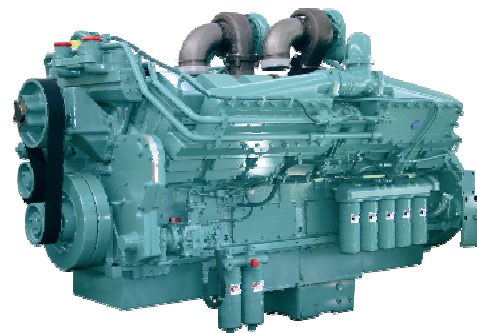

> Specification sheet



Our energy working for you.™

Description

The KTA50-Series benefits from years of technical development and improvement to bring customers an innovative and future proof diesel engine that keeps pace with ever changing generator set requirements.

Recognised globally for its performance under even the most severe climatic conditions, the KTA50-Series is widely acknowledged as the most robust and cost-effective diesel engine in its power range for the generator set market.



This engine has been built to comply with CE certification.



This engine has been designed in facilities certified to ISO9001 and manufactured in facilities certified to ISO9001 or ISO9002.

Features

Coolpac Integrated Design - Products are supplied complete with cooling package and air cleaner kit for a complete power package. Each component has been specifically developed and rigorously tested for G-Drive products, ensuring high performance, durability and reliability.

Aftercooler – Large capacity aftercoolers result in cooler, denser intake air for more efficient combustion and reduced internal stresses for longer life.

Cooling System – Gear driven centrifugal water pump. Large volume water passages provide even flow of coolant around cylinder liners, valves and injectors.

Pistons – Aluminium alloy, cam ground and barrel shaped to compensate for thermal expansion assures precise fit at operating temperatures. Grooved skirt finish provides superior lubrication. Oil cooled for rapid heat dissipation.

Service and Support - G-Drive products are backed by an uncompromising level of technical support and after sales service, delivered through a world class service network.

1500 rpm (50 Hz Ratings)

Gross Engine Output			Net Engine Output			Typical Generator Set Output					
Standby	Prime	Base	Standby	Prime	Base	Standby (ESP)		Prime (PRP)		Base (COP)	
kWm/BHP			kWm/BHP			kWe	kVA	kWe	kVA	kWe	kVA
1227/1645	1097/1470	900/1206	1192/1598	1074/1440	877/1176	1120	1400	1020	1275	842	1052

1800 rpm (60 Hz Ratings)

Gross Engine Output			Net Engine Output			Typical Generator Set Output					
Standby	Prime	Base	Standby	Prime	Base	Standby (ESP)		Prime (PRP)		Base (COP)	
kWm/BHP			kWm/BHP			kWe	kVA	kWe	kVA	kWe	kVA
1380/1850	1220/1635	1000/1340	1328/1781	1182/1585	962/1290	1250	1610	1135	1418	924	1154



General Engine Data

Type	4 cycle, In line, Turbocharged and After-cooled
Bore mm	158.8
Stroke mm	158.8
Displacement Litre	50
Cylinder Block	16-cylinder, direct injection, 4-cycle diesel engine
Battery Charging Alternator	55A
Starting Voltage	24V
Fuel System	Direct injection
Fuel Filter	Dual spin on paper element fuel filters with standard water separator
Lube Oil Filter Type(s)	Spin on full flow filter
Lube Oil Capacity (l)	177
Flywheel Dimensions	SAE 0

Coolpac Performance Data

Cooling System Design	Jacket Water After Cooled	
Coolant Ratio	50% ethylene glycol; 50% water	
Coolant Capacity (l)	152.0	
Limiting Ambient Temp (°C)**	55.6 (50Hz)	51.0 (60Hz)
Fan Power (kWm)	21.0 (50Hz)	36.0 (60Hz)
Cooling System Air Flow (m ³ /s)**	30.3 (50Hz)	34.6 (60Hz)
Air Cleaner Type	Dry replaceable element with restriction indicator	

** @ 13 mm H₂O

Ratings Definitions

Emergency Standby Power (ESP):

Applicable for supplying power to varying electrical load for the duration of power interruption of a reliable utility source. Emergency Standby Power (ESP) is in accordance with ISO 8528. Fuel Stop power in accordance with ISO 3046, AS 2789, DIN 6271 and BS 5514.

Limited-Time Running Power (LTP):

Applicable for supplying power to a constant electrical load for limited hours. Limited-Time Running Power (LTP) is in accordance with ISO 8528.

Prime Power (PRP):

Applicable for supplying power to varying electrical load for unlimited hours. Prime Power (PRP) is in accordance with ISO 8528. Ten percent overload capability is available in accordance with ISO 3046, AS 2789, DIN 6271 and BS 5514.

Base Load (Continuous) Power (COP):

Applicable for supplying power continuously to a constant electrical load for unlimited hours. Continuous Power (COP) in accordance with ISO 8528, ISO 3046, AS 2789, DIN6271 and BS 5514.

Weight & Dimensions

Length	Width	Height	Weight (dry)
mm	mm	mm	kg
3275	2000	2200	5900

Fuel Consumption 1500 rpm (50 Hz)

%	kWm	BHP	L/ph	US gal/ph
Standby Power				
100	1227	1645	293	77.4
Prime Power				
100	1097	1470	261	69.0
75	822	1102	199	52.5
50	548	735	139	36.6
25	275	368	76	20.0
Continuous Power				
100	900	1206	216	57.1

Fuel Consumption 1800 rpm (60 Hz)

%	kWm	BHP	L/ph	US gal/ph
Standby Power				
100	1380	1850	330	87.3
Prime Power				
100	1220	1635	291	76.9
75	915	1226	222	58.7
50	610	818	157	41.6
25	305	409	89	23.6
Continuous Power				
100	1000	1340	242	63.8

Cummins G-Drive Engines

Asia Pacific

10 Toh Guan Road
#07-01
TT International Tradepark
Singapore 608838
Phone 65 6417 2388
Fax 65 6417 2399

Europe, CIS, Middle

East and Africa
Manston Park Columbus Ave
Manston Ramsgate
Kent CT12 5BF, UK
Phone 44 1843 255000
Fax 44 1843 255902

Latin America

Rua Jati, 310, Cumbica
Guarulhos, SP 07180-900
Brazil
Phone 55 11 2186 4552
Fax 55 11 2186 4729

Mexico

Cummins S. de R.L. de C.V.
Eje 122 No. 200 Zona Industrial
San Luis Potosi, S.L.P. 78090
Mexico
Phone 52 444 870 6700
Fax 52 444 870 6811

North America

1400 73rd Avenue N.E.
Minneapolis, MN 55432
USA
Phone 1 763 574 5000
USA Toll-free 1 877 769 7669
Fax 1 763 574 5298



PI734A - Technical Data Sheet

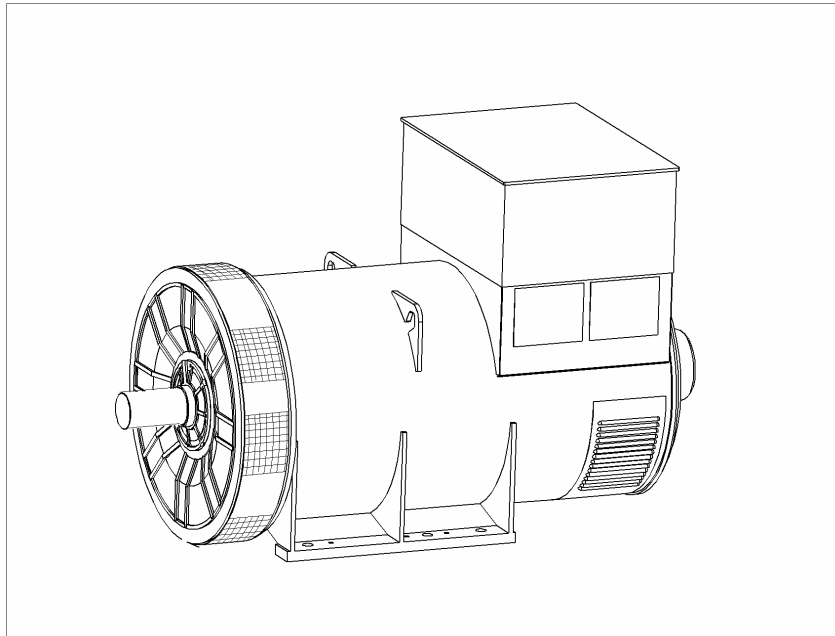

PI734A

SPECIFICATIONS & OPTIONS



STANDARDS

Newage Stamford industrial generators meet the requirements of BS EN 60034 and the relevant sections of other national and international standards such as BS5000, VDE 0530, NEMA MG1-32, IEC60034, CSA C22.2-100, AS1359.

Other standards and certifications can be considered on request.

DESCRIPTION

The STAMFORD PI range of synchronous ac generators are brushless with a rotating field. They are separately excited by the STAMFORD Permanent Magnet Generator (PMG). This is a shaft mounted, high frequency, pilot exciter which provides a constant supply of clean power via the Automatic Voltage Regulator (AVR) to the main exciter. The main exciter output is fed to the main rotor, through a full wave bridge rectifier, protected by surge suppression.

VOLTAGE REGULATORS

The PI range generators complete with a PMG are available with one of two AVRs. Each AVR has soft start voltage build up and built in protection against sustained over-excitation, which will de-excite the generator after a minimum of 8 seconds.

Underspeed protection (UFRO) is also provided on both AVRs. The UFRO will reduce the generator output voltage proportional to the speed of the generator below a pre-settable level.

The **MX341 AVR** is two phase sensed with a voltage regulation of $\pm 1\%$. (see the note on regulation).

The **MX321 AVR** is 3 phase rms sensed with a voltage regulation of 0.5% rms (see the note on regulation). The UFRO circuit has adjustable slope and dwell for controlled recovery from step loads. An over voltage protection circuit will shutdown the output device of the AVR, it can also trip an optional excitation circuit breaker if required. As an option, short circuit current limiting is available with the addition of current transformers.

Both the MX341 and the MX321 need a generator mounted current transformer to provide quadrature droop characteristics for load sharing during parallel operation. Provision is also made for the connection of the STAMFORD power factor controller, for embedded applications, and a remote voltage trimmer.

WINDINGS & ELECTRICAL PERFORMANCE

All generator stators are wound to 2/3 pitch. This eliminates triplen (3rd, 9th, 15th ...) harmonics on the voltage waveform and is found to be the optimum design for trouble-free supply of non-linear loads. The 2/3 pitch design avoids excessive neutral currents sometimes seen with higher winding pitches. A fully connected damper winding reduces oscillations during paralleling. This winding, with the 2/3 pitch and carefully selected pole and tooth designs, ensures very low levels of voltage waveform distortion.

TERMINALS & TERMINAL BOX

Standard generators feature a main stator with 6 ends brought out to the terminals, which are mounted on the frame at the non-drive end of the generator. A sheet metal terminal box contains the AVR and provides ample space for the customers' wiring and gland arrangements. It has removable panels for easy access.

SHAFT & KEYS

All generator rotors are dynamically balanced to better than BS6861:Part 1 Grade 2.5 for minimum vibration in operation. Two bearing generators are balanced with a half key.

INSULATION/IMPREGNATION

The insulation system is class 'H', and meets the requirements of UL1446.

All wound components are impregnated with materials and processes designed specifically to provide the high build required for static windings and the high mechanical strength required for rotating components.

QUALITY ASSURANCE

Generators are manufactured using production procedures having a quality assurance level to BS EN ISO 9001.

NOTE ON REGULATION

The stated voltage regulation may not be maintained in the presence of certain radio transmitted signals. Any change in performance will fall within the limits of Criteria 'B' of EN 61000-6-2:2001. At no time will the steady-state voltage regulation exceed 2%.

NB Continuous development of our products entitles us to change specification details without notice, therefore they must not be regarded as binding.

Front cover drawing is typical of the product range.

PI734A
WINDING 312

CONTROL SYSTEM	SEPARATELY EXCITED BY P.M.G.		
A.V.R.	MX341	MX321	
VOLTAGE REGULATION	± 1%	± 0.5 %	With 4% ENGINE GOVERNING
SUSTAINED SHORT CIRCUIT	REFER TO SHORT CIRCUIT DECREMENT CURVES (page 7)		

INSULATION SYSTEM	CLASS H							
PROTECTION	IP23							
RATED POWER FACTOR	0.8							
STATOR WINDING	DOUBLE LAYER LAP							
WINDING PITCH	TWO THIRDS							
WINDING LEADS	6							
MAIN STATOR RESISTANCE	0.0016 Ohms PER PHASE AT 22°C STAR CONNECTED							
MAIN ROTOR RESISTANCE	1.67 Ohms at 22°C							
EXCITER STATOR RESISTANCE	17.5 Ohms at 22°C							
EXCITER ROTOR RESISTANCE	0.048 Ohms PER PHASE AT 22°C							
R.F.I. SUPPRESSION	BS EN 61000-6-2 & BS EN 61000-6-4,VDE 0875G, VDE 0875N. refer to factory for others							
WAVEFORM DISTORTION	NO LOAD < 1.5% NON-DISTORTING BALANCED LINEAR LOAD < 5.0%							
MAXIMUM OVERSPEED	2250 Rev/Min							
BEARING DRIVE END	BALL. 6228 C3							
BEARING NON-DRIVE END	BALL. 6319 C3							
	1 BEARING				2 BEARING			
WEIGHT COMP. GENERATOR	2760 kg				2710 kg			
WEIGHT WOUND STATOR	1306 kg				1306 kg			
WEIGHT WOUND ROTOR	1139 kg				1077 kg			
WR ² INERTIA	32.7498 kgm ²				31.7489 kgm ²			
SHIPPING WEIGHTS in a crate	2833kg				2779kg			
PACKING CRATE SIZE	194 x 105 x 154(cm)				194 x 105 x 154(cm)			
	50 Hz				60 Hz			
TELEPHONE INTERFERENCE	THF<2%				TIF<50			
COOLING AIR	2.69 m ³ /sec 5700 cfm				3.45 m ³ /sec 7300 cfm			
VOLTAGE STAR	380/220	400/231	415/240	440/254	416/240	440/254	460/266	480/277
kVA BASE RATING FOR REACTANCE VALUES	1225	1260	1260	1235	1370	1500	1510	1525
X _d DIR. AXIS SYNCHRONOUS	3.51	3.26	3.02	2.64	4.23	4.14	3.81	3.53
X' _d DIR. AXIS TRANSIENT	0.21	0.20	0.18	0.16	0.26	0.25	0.23	0.22
X'' _d DIR. AXIS SUBTRANSIENT	0.16	0.15	0.14	0.12	0.19	0.19	0.17	0.16
X _q QUAD. AXIS REACTANCE	2.26	2.10	1.95	1.70	2.73	2.67	2.46	2.28
X'' _q QUAD. AXIS SUBTRANSIENT	0.32	0.29	0.27	0.24	0.38	0.37	0.34	0.32
X _L LEAKAGE REACTANCE	0.04	0.04	0.03	0.03	0.05	0.05	0.04	0.04
X ₂ NEGATIVE SEQUENCE	0.22	0.21	0.19	0.17	0.27	0.26	0.24	0.23
X ₀ ZERO SEQUENCE	0.03	0.03	0.02	0.02	0.03	0.03	0.03	0.03
REACTANCES ARE SATURATED				VALUES ARE PER UNIT AT RATING AND VOLTAGE INDICATED				
T' _d TRANSIENT TIME CONST.	0.13s							
T'' _d SUB-TRANSTIME CONST.	0.01s							
T' _{do} O.C. FIELD TIME CONST.	2.14s							
T _a ARMATURE TIME CONST.	0.02s							
SHORT CIRCUIT RATIO	1/X _d							

**50
Hz**

PI734A
Winding 312



THREE PHASE EFFICIENCY CURVES

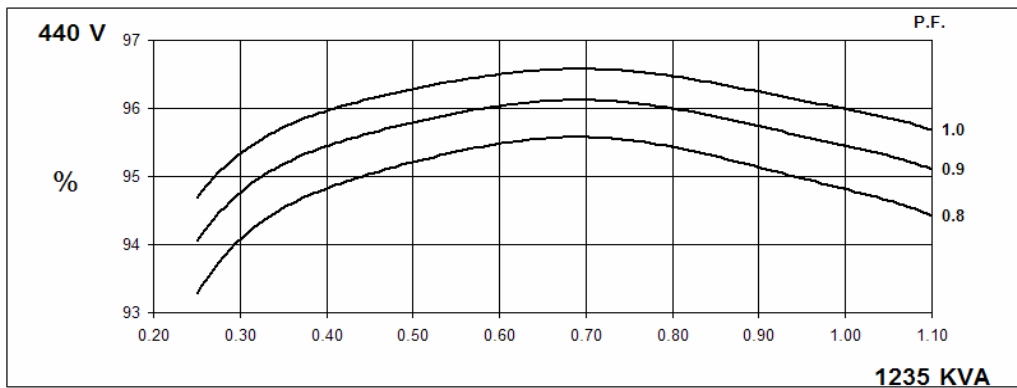
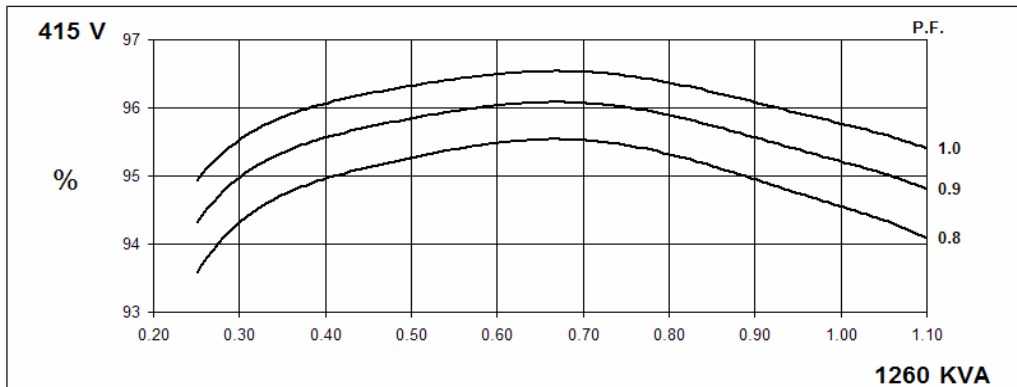
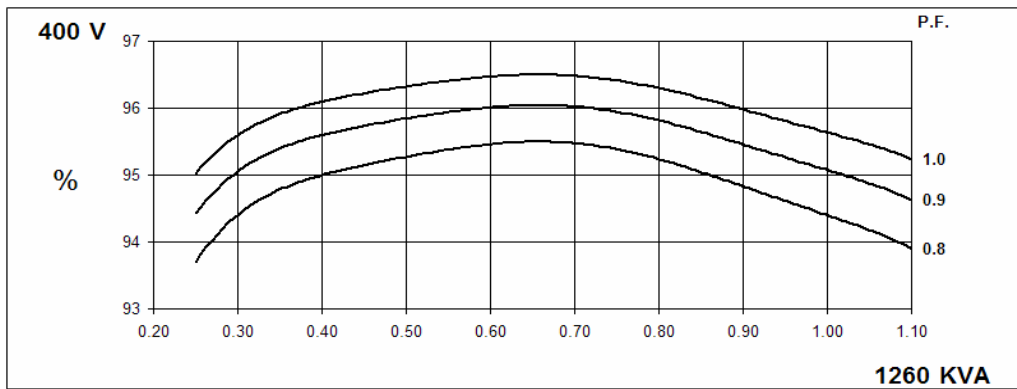
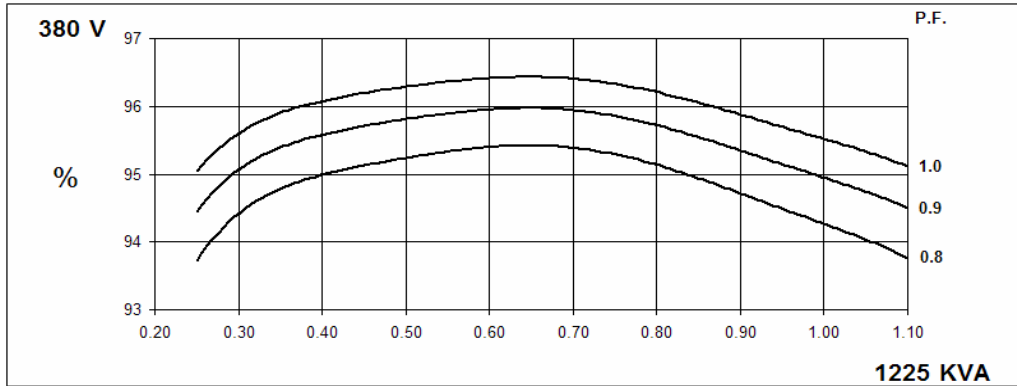

THREE PHASE EFFICIENCY CURVES

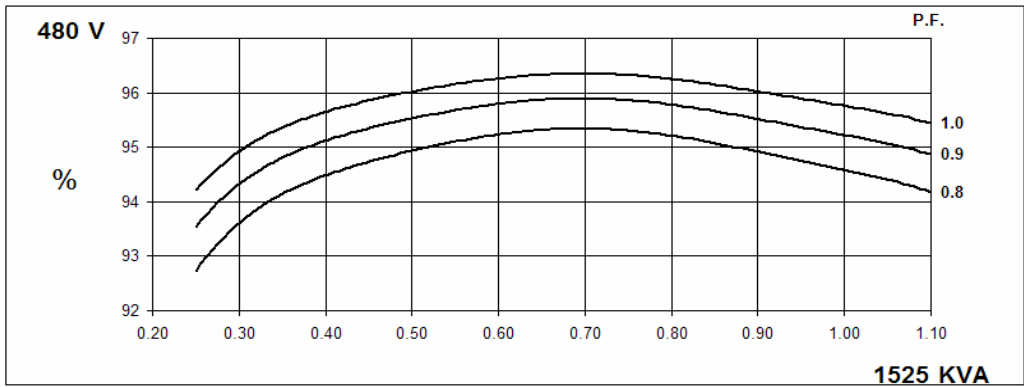
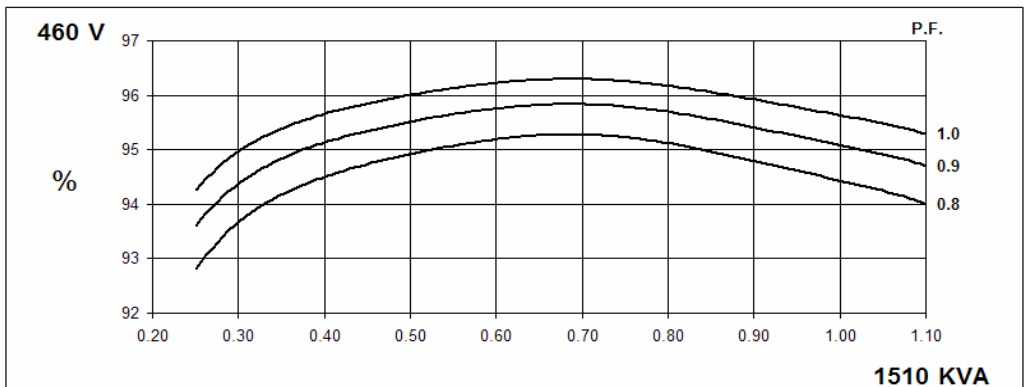
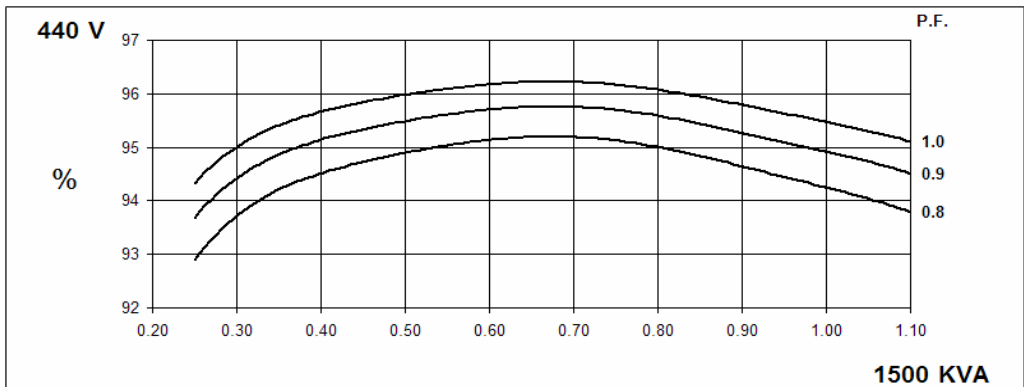
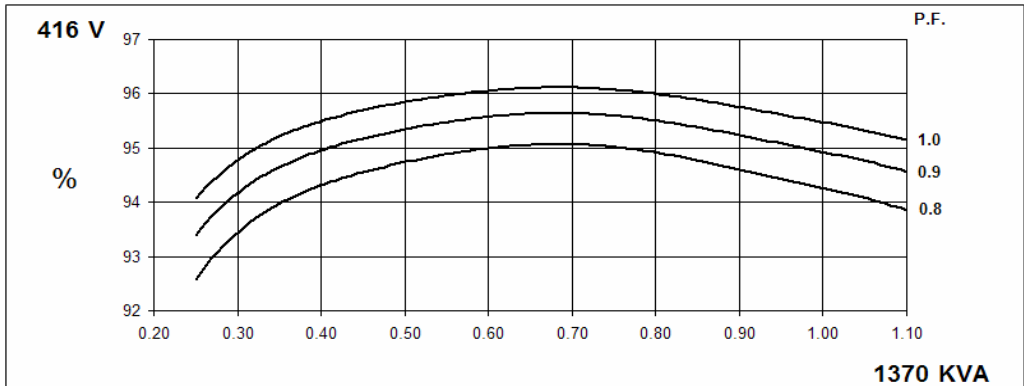

PI734A
Winding 312



Locked Rotor Motor Starting Curve

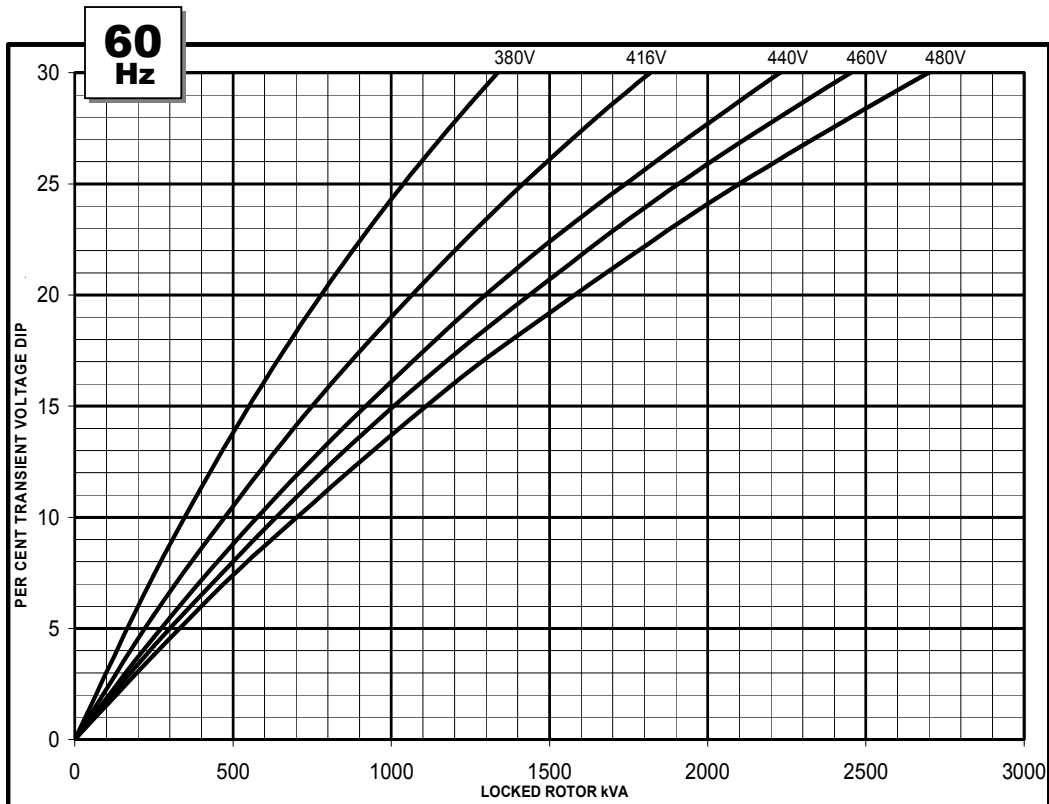

**Three-phase Short Circuit Decrement Curve. No-load Excitation at Rated Speed
Based on star (wye) connection.**

**50
Hz**

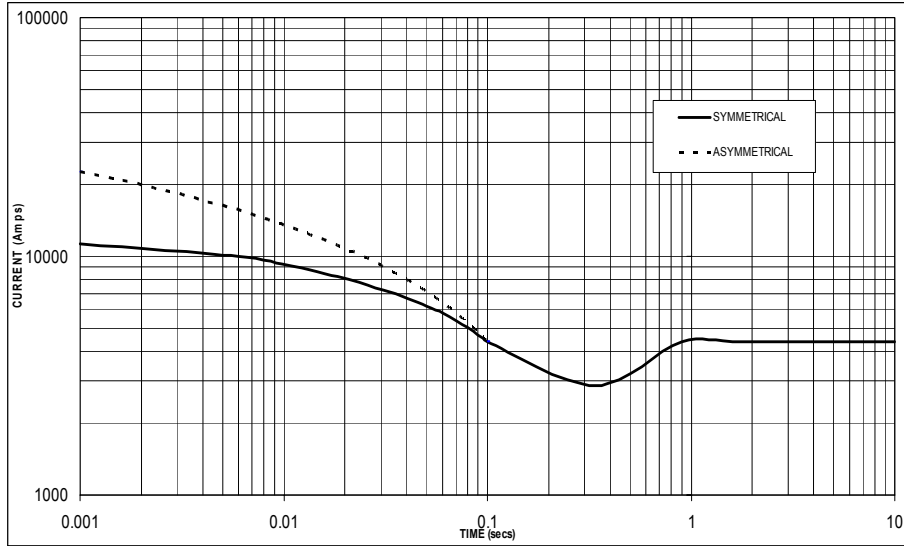

Sustained Short Circuit = 4,400 Amps

**60
Hz**

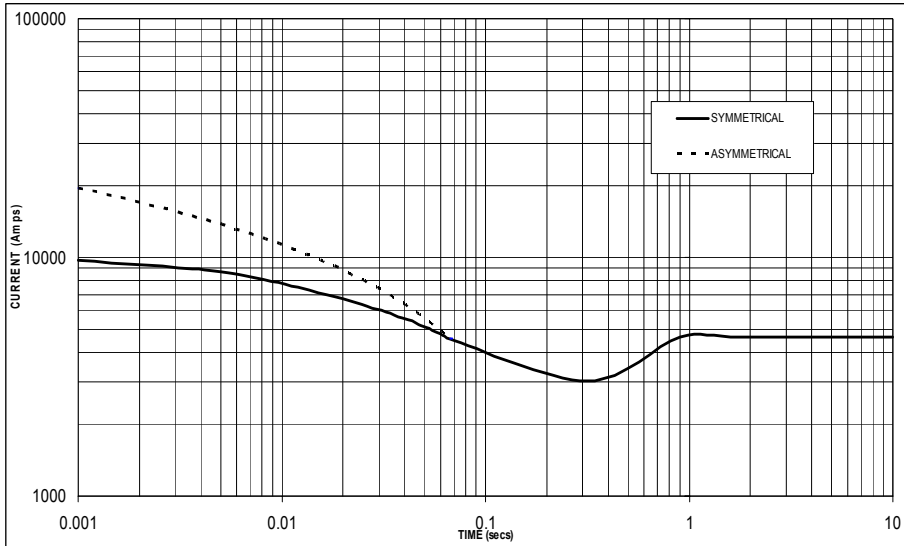

Sustained Short Circuit = 4,650 Amps

Note 1

The following multiplication factors should be used to adjust the values from curve between time 0.001 seconds and the minimum current point in respect of nominal operating voltage :

50Hz		60Hz	
Voltage	Factor	Voltage	Factor
380v	x 1.00	416v	x 1.00
400v	x 1.05	440v	x 1.06
415v	x 1.09	460v	x 1.10
440v	x 1.16	480v	x 1.15

The sustained current value is constant irrespective of voltage level

Note 2

The following multiplication factor should be used to convert the values calculated in accordance with NOTE 1 to those applicable to the various types of short circuit :

	3-phase	2-phase L-L	1-phase L-N
Instantaneous	x 1.00	x 0.87	x 1.30
Minimum	x 1.00	x 1.80	x 3.20
Sustained	x 1.00	x 1.50	x 2.50
Max. sustained duration	10 sec.	5 sec.	2 sec.

All other times are unchanged

Note 3

Curves are drawn for Star (Wye) connected machines.

PI734A

Winding 312 / 0.8 Power Factor



RATINGS

Class - Temp Rise		Cont. F - 105/40°C				Cont. H - 125/40°C				Standby - 150/40°C				Standby - 163/27°C			
50Hz	Star (V)	380	400	415	440	380	400	415	440	380	400	415	440	380	400	415	440
	kVA	1140	1175	1175	1150	1225	1260	1260	1235	1275	1315	1315	1290	1310	1350	1350	1325
	kW	912	940	940	920	980	1008	1008	988	1020	1052	1052	1032	1048	1080	1080	1060
	Efficiency (%)	94.5	94.6	94.8	95.0	94.3	94.4	94.6	94.8	94.1	94.2	94.4	94.7	94.0	94.1	94.3	94.6
	kW Input	965	994	992	968	1039	1068	1066	1042	1084	1117	1114	1090	1115	1148	1145	1121

60Hz	Star (V)	416	440	460	480	416	440	460	480	416	440	460	480	416	440	460	480
	kVA	1275	1395	1405	1415	1370	1500	1510	1525	1425	1560	1570	1585	1465	1605	1615	1630
	kW	1020	1116	1124	1132	1096	1200	1208	1220	1140	1248	1256	1268	1172	1284	1292	1304
	Efficiency (%)	94.5	94.5	94.6	94.8	94.3	94.2	94.4	94.6	94.1	94.1	94.3	94.5	94.0	94.0	94.2	94.4
	kW Input	1079	1181	1188	1194	1162	1274	1280	1290	1211	1326	1332	1342	1247	1366	1372	1381

DIMENSIONS

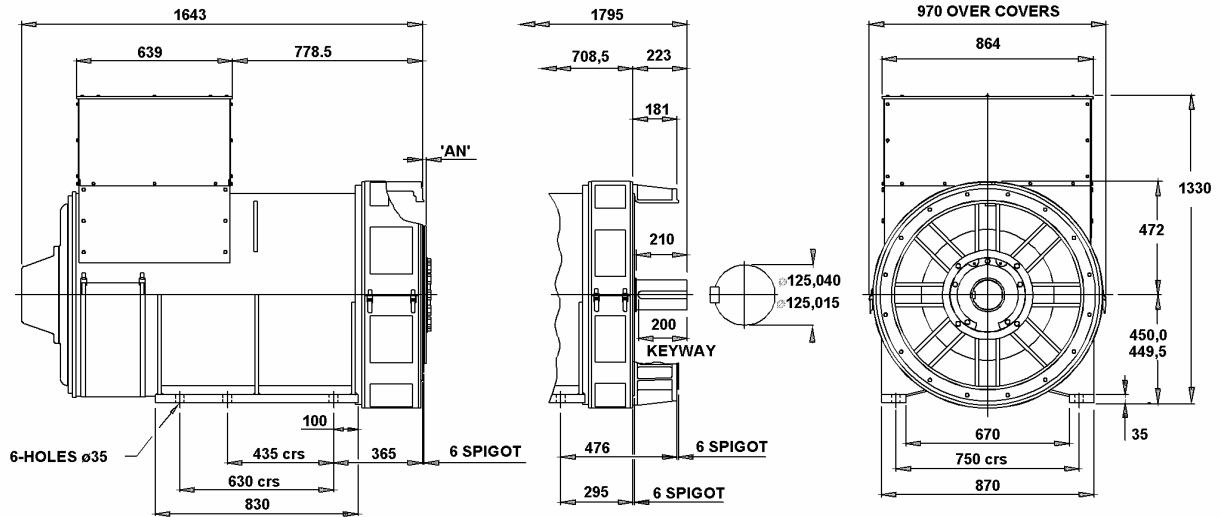

COUPLING DISC	'AN'
S.A.E No 18	15,7
S.A.E No 21	0
S.A.E No 24	0

1-BRG ADAPTORS
S.A.E No 0
S.A.E No 00

2-BRG ADAPTORS
S.A.E No 0
S.A.E No 00



Barnack Road • Stamford • Lincolnshire • PE9 2NB
 Tel: 00 44 (0)1780 484000 • Fax: 00 44 (0)1780 484100

KTA38-G5



Typical picture

> Specification sheet



Our energy working for you.™

Description

The KTA38-Series benefits from years of technical development and improvement to bring customers an innovative and future proof diesel engine that keeps pace with ever changing generator set requirements.

Recognized globally for its performance under even the most severe climatic conditions, the KTA38-Series is widely acknowledged as the most robust and cost-effective diesel engine in its power range for the generator set market.



This engine has been built to comply with CE certification.



This engine has been designed in facilities certified to ISO9001 and manufactured in facilities certified to ISO9001 or ISO9002.

Features

Aftercooler – Large capacity after cooler results in cooler, denser intake air for more efficient combustion and reduced internal stresses for longer life.

Fuel System – Cummins exclusive low pressure PT™ system with wear compensating pump and integral dual flyweight governor. Camshaft actuated fuel injectors give accurate metering and timing. Fuel lines are internal drilled passages in cylinder heads. Spin-on fuel filter.

Cooling System – Gear driven centrifugal water pump. Large volume water passages provide even flow of coolant around cylinder liners, valves and injectors. Bypass thermostats regulate coolant temperature. Spin-on corrosion resistors check rust and corrosion, control acidity and remove impurities.

Cylinder Block – Alloy cast iron with removable wet liners. Cross bolt support to main bearing cap provides extra strength and stability.

Turbocharger – Cummins Turbo Technologies (CTT) exhaust gas driven turbocharger mounted at top of engine provides more power, improved fuel economy, altitude compensation, and lower smoke and noise levels.

Service and Support - G-Drive products are backed by an uncompromising level of technical support and after sales service, delivered through a world class service network.

1500 rpm (50 Hz Ratings)

Gross Engine Output			Net Engine Output			Typical Generator Set Output					
Standby	Prime	Base	Standby	Prime	Base	Standby (ESP)		Prime (PRP)		Base (COP)	
kWm/BHP			kWm/BHP			kWe	kVA	kWe	kVA	kWe	kVA
970/1300	880/1180	656/880	937/1257	857/1149	633/849	880	1100	800	1000	600	750



General Engine Data

Type	4 cycle, Turbocharged and After-cooled
Bore mm	159
Stroke mm	159
Displacement Liter	38
Cylinder Block	12-cylinder, direct injection, 4-cycle diesel engine
Battery Charging Alternator	35A
Starting Voltage	24V
Fuel System	Direct injection, EFC (Electric Fuel control) governor
Fuel Filter	Dual spin on paper element fuel filters with standard water separator
Lube Oil Filter Type(s)	Spin on full flow filter
Lube Oil Capacity (l)	140
Flywheel Dimensions	SAE 0

Coolpac Performance Data

Cooling System Design	JWAC
Coolant Ratio	50% ethylene glycol; 50% water
Total Coolant Capacity (l)	218.5
Limiting Ambient Temp (°C)**	50
Fan Power (kWm)	20
Cooling System Air Flow (m ³ /s)**	18.9
Air Cleaner Type	Dry replaceable element with restriction indicator

** @ 13 mm H₂O

Weight & Dimensions

Length	Width	Height	Weight (dry)
mm	mm	mm	kg
3172	1752	2004	4990

Note: Weights represent CoolPac with Light Duty Air Cleaner. See Outline drawings for weights and dimensions for Heavy Duty Air Cleaner configuration.

Fuel Consumption 1500 rpm (50 Hz)

%	kWm	BHP	L/ph	US gal/ph
Standby Power				
100	970	1300	228	60.3
Prime Power				
100	880	1180	209	55.1
75	660	885	161	42.5
50	440	590	113	29.9
25	220	295	65	17.3
Continuous Power				
100	656	880	158	41.7

Cummins G-Drive Engines

Asia Pacific

10 Toh Guan Road
#07-01
TT International Tradepark
Singapore 608838
Phone 65 6417 2388
Fax 65 6417 2399

Europe, CIS, Middle East and Africa

Manston Park Columbus Ave
Manston Ramsgate
Kent CT12 5BF. UK
Phone 44 1843 255000
Fax 44 1843 255902

Latin America

Rua Jati, 310, Cumbica
Guarulhos, SP 07180-900
Brazil
Phone 55 11 2186 4552
Fax 55 11 2186 4729

Mexico

Cummins S. de R.L. de C.V.
Eje 122 No. 200 Zona Industrial
San Luis Potosí, S.L.P. 78090
Mexico
Phone 52 444 870 6700
Fax 52 444 870 6811

North America

1400 73rd Avenue N.E.
Minneapolis, MN 55432
USA
Phone 1 763 574 5000
USA Toll-free 1 877 769 7669
Fax 1 763 574 5298

Ratings Definitions

Emergency Standby Power (ESP):

Applicable for supplying power to varying electrical load for the duration of power interruption of a reliable utility source. Emergency Standby Power (ESP) is in accordance with ISO 8528. Fuel Stop power in accordance with ISO 3046, AS 2789, DIN 6271 and BS 5514.

Limited-Time Running Power (LTP):

Applicable for supplying power to a constant electrical load for limited hours. Limited-Time Running Power (LTP) is in accordance with ISO 8528.

Prime Power (PRP):

Applicable for supplying power to varying electrical load for unlimited hours. Prime Power (PRP) is in accordance with ISO 8528. Ten percent overload capability is available in accordance with ISO 3046, AS 2789, DIN 6271 and BS 5514.

Base Load (Continuous) Power (COP):

Applicable for supplying power continuously to a constant electrical load for unlimited hours. Continuous Power (COP) in accordance with ISO 8528, ISO 3046, AS 2789, DIN6271 and BS 5514.



HCI634J - Technical Data Sheet

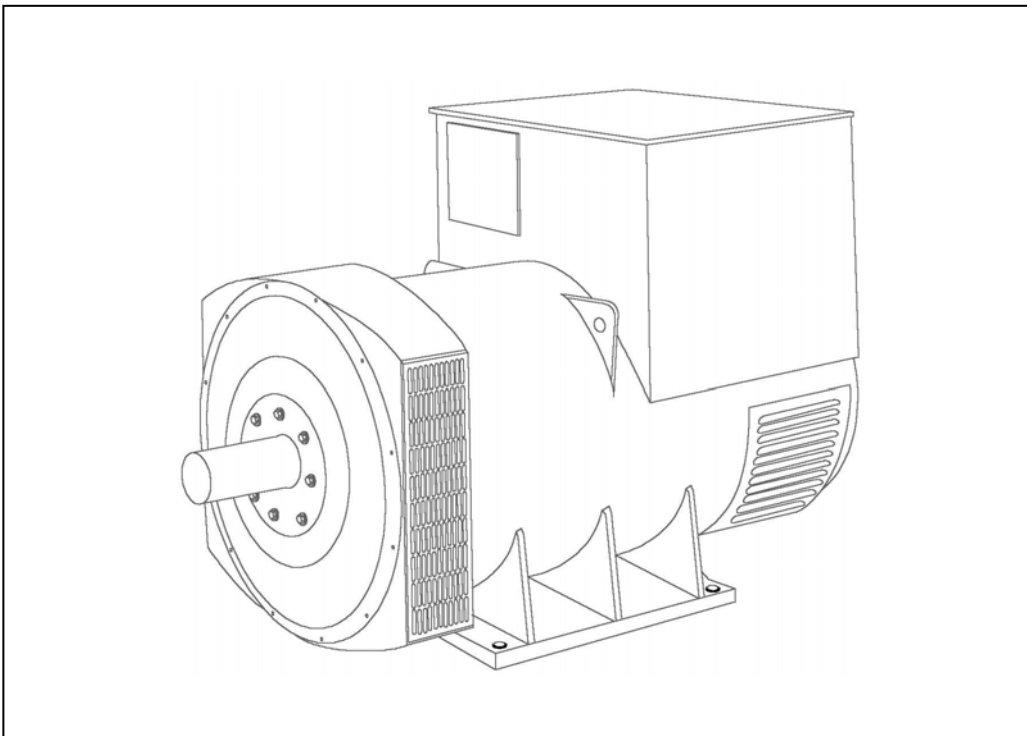

HCI634J

SPECIFICATIONS & OPTIONS



STANDARDS

Newage Stamford industrial generators meet the requirements of BS EN 60034 and the relevant section of other international standards such as BS5000, VDE 0530, NEMA MG1-32, IEC34, CSA C22.2-100, AS1359. Other standards and certifications can be considered on request.

VOLTAGE REGULATORS

MX321 AVR - STANDARD

This sophisticated Automatic Voltage Regulator (AVR) is incorporated into the Stamford Permanent Magnet Generator (PMG) system and is fitted as standard to generators of this type.

The PMG provides power via the AVR to the main exciter, giving a source of constant excitation power independent of generator output. The main exciter output is then fed to the main rotor, through a full wave bridge, protected by a surge suppressor. The AVR has in-built protection against sustained over-excitation, caused by internal or external faults. This de-excites the machine after a minimum of 5 seconds.

Over voltage protection is built-in and short circuit current level adjustments is an optional facility.

WINDINGS & ELECTRICAL PERFORMANCE

All generator stators are wound to 2/3 pitch. This eliminates triplen (3rd, 9th, 15th ...) harmonics on the voltage waveform and is found to be the optimum design for trouble-free supply of non-linear loads. The 2/3 pitch design avoids excessive neutral currents sometimes seen with higher winding pitches, when in parallel with the mains. A fully connected damper winding reduces oscillations during paralleling. This winding, with the 2/3 pitch and carefully selected pole and tooth designs, ensures very low waveform distortion.

TERMINALS & TERMINAL BOX

Standard generators feature a main stator with 6 ends brought out to the terminals, which are mounted on the frame at the non-drive end of the generator. A sheet steel terminal box contains the AVR and provides ample space for the customers' wiring and gland arrangements. It has removable panels for easy access.

SHAFT & KEYS

All generator rotors are dynamically balanced to better than BS6861:Part 1 Grade 2.5 for minimum vibration in operation. Two bearing generators are balanced with a half key.

INSULATION/IMPREGNATION

The insulation system is class 'H'.

All wound components are impregnated with materials and processes designed specifically to provide the high build required for static windings and the high mechanical strength required for rotating components.

QUALITY ASSURANCE

Generators are manufactured using production procedures having a quality assurance level to BS EN ISO 9001.

The stated voltage regulation may not be maintained in the presence of certain radio transmitted signals. Any change in performance will fall within the limits of Criteria 'B' of EN 61000-6-2:2001. At no time will the steady-state voltage regulation exceed 2%.

NB Continuous development of our products entitles us to change specification details without notice, therefore they must not be regarded as binding.

Front cover drawing typical of product range.

HCI634J
WINDING 312

CONTROL SYSTEM	SEPARATELY EXCITED BY P.M.G.		
A.V.R.	MX321		
VOLTAGE REGULATION	± 0.5 %	With 4% ENGINE GOVERNING	
SUSTAINED SHORT CIRCUIT	REFER TO SHORT CIRCUIT DECREMENT CURVES (page 7)		

INSULATION SYSTEM	CLASS H							
PROTECTION	IP23							
RATED POWER FACTOR	0.8							
STATOR WINDING	DOUBLE LAYER LAP							
WINDING PITCH	TWO THIRDS							
WINDING LEADS	6							
STATOR WDG. RESISTANCE	0.002 Ohms PER PHASE AT 22°C STAR CONNECTED							
ROTOR WDG. RESISTANCE	2.09 Ohms at 22°C							
R.F.I. SUPPRESSION	BS EN 61000-6-2 & BS EN 61000-6-4, VDE 0875G, VDE 0875N. refer to factory for others							
WAVEFORM DISTORTION	NO LOAD < 1.5% NON-DISTORTING BALANCED LINEAR LOAD < 5.0%							
MAXIMUM OVERSPEED	2250 Rev/Min							
BEARING DRIVE END	BALL. 6224 (ISO)							
BEARING NON-DRIVE END	BALL. 6317 (ISO)							
	1 BEARING				2 BEARING			
WEIGHT COMP. GENERATOR	2279 kg				2300 kg			
WEIGHT WOUND STATOR	1120 kg				1120 kg			
WEIGHT WOUND ROTOR	962 kg				916 kg			
WR ² INERTIA	22.9287 kgm ²				22.3814 kgm ²			
SHIPPING WEIGHTS in a crate	2328kg				2329kg			
PACKING CRATE SIZE	183 x 92 x 140(cm)				183 x 92 x 140(cm)			
	50 Hz				60 Hz			
TELEPHONE INTERFERENCE	THF<2%				TIF<50			
COOLING AIR	1.614 m ³ /sec 3420 cfm				1.961 m ³ /sec 4156 cfm			
VOLTAGE STAR	380/220	400/231	415/240	440/254	416/240	440/254	460/266	480/277
VOLTAGE DELTA	220	230	240	254	240	254	266	277
kVA BASE RATING FOR REACTANCE VALUES	1000	1000	1000	1000	1150	1200	1250	1300
X _d DIR. AXIS SYNCHRONOUS	3.02	2.73	2.54	2.26	3.49	3.25	3.10	2.96
X' _d DIR. AXIS TRANSIENT	0.24	0.22	0.20	0.18	0.28	0.26	0.25	0.24
X'' _d DIR. AXIS SUBTRANSIENT	0.17	0.15	0.14	0.12	0.19	0.18	0.17	0.16
X _q QUAD. AXIS REACTANCE	1.78	1.61	1.50	1.33	2.05	1.91	1.82	1.74
X'' _q QUAD. AXIS SUBTRANSIENT	0.21	0.19	0.18	0.16	0.25	0.23	0.22	0.21
X _L LEAKAGE REACTANCE	0.09	0.08	0.08	0.07	0.10	0.10	0.09	0.09
X ₂ NEGATIVE SEQUENCE	0.21	0.19	0.18	0.16	0.25	0.23	0.22	0.21
X ₀ ZERO SEQUENCE	0.03	0.02	0.02	0.02	0.03	0.03	0.03	0.03
REACTANCES ARE SATURATED VALUES ARE PER UNIT AT RATING AND VOLTAGE INDICATED								
T' _d TRANSIENT TIME CONST.	0.185							
T'' _d SUB-TRANSTIME CONST.	0.025							
T' _{do} O.C. FIELD TIME CONST.	3.03							
T _a ARMATURE TIME CONST.	0.046							
SHORT CIRCUIT RATIO	1/X _d							

**50
Hz**

HCI634J
Winding 312



THREE PHASE EFFICIENCY CURVES

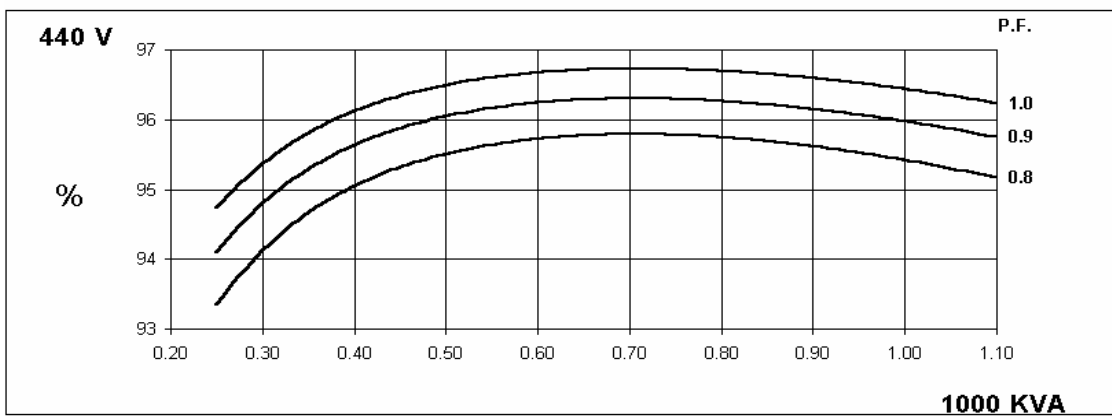
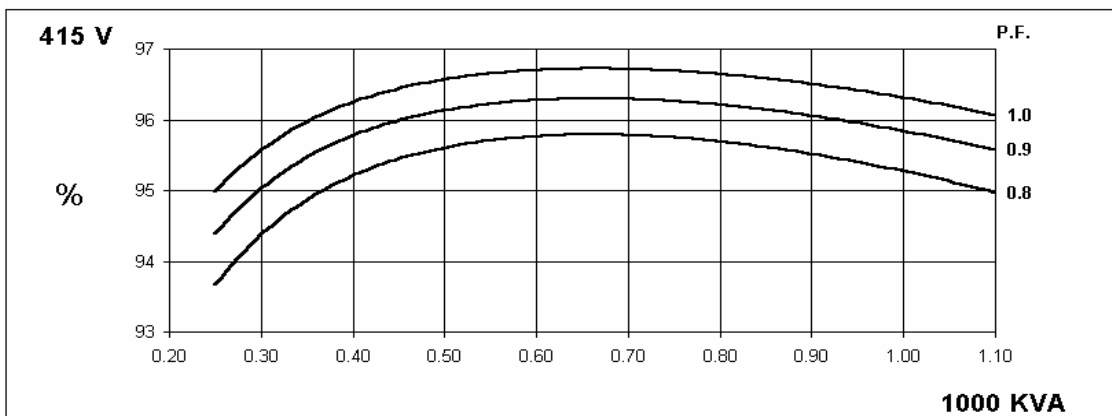
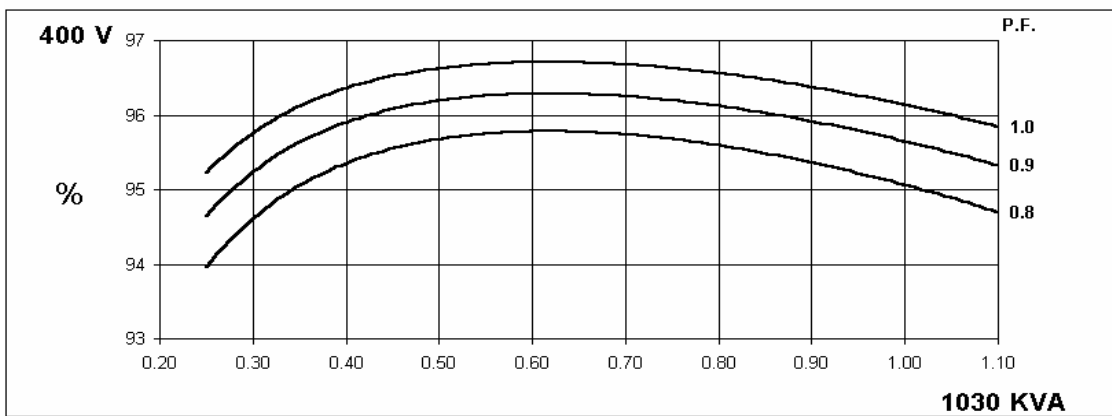
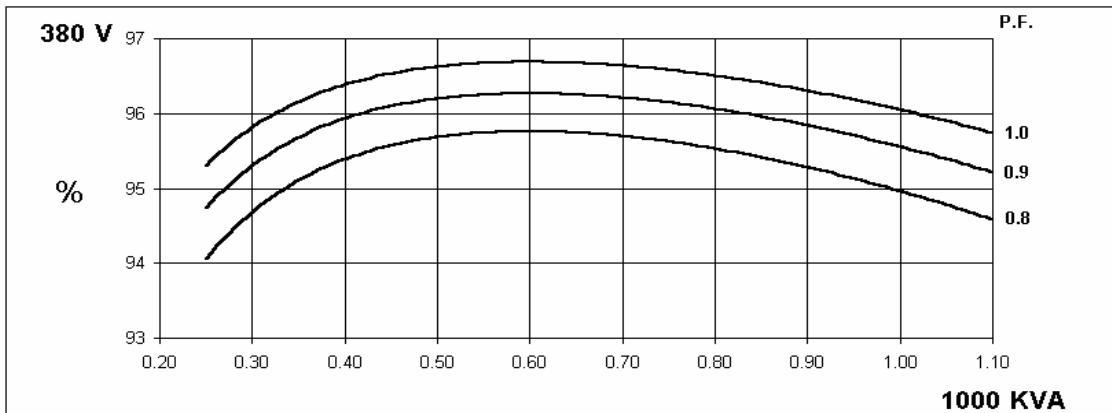

THREE PHASE EFFICIENCY CURVES

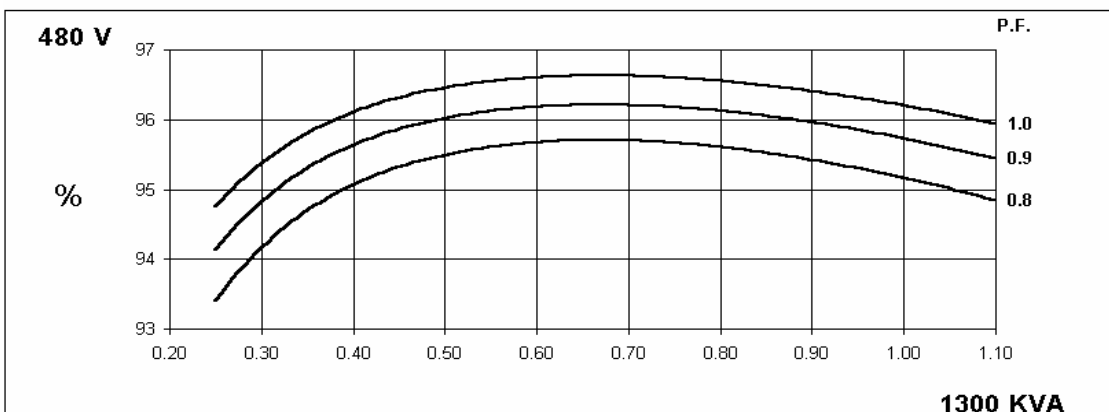
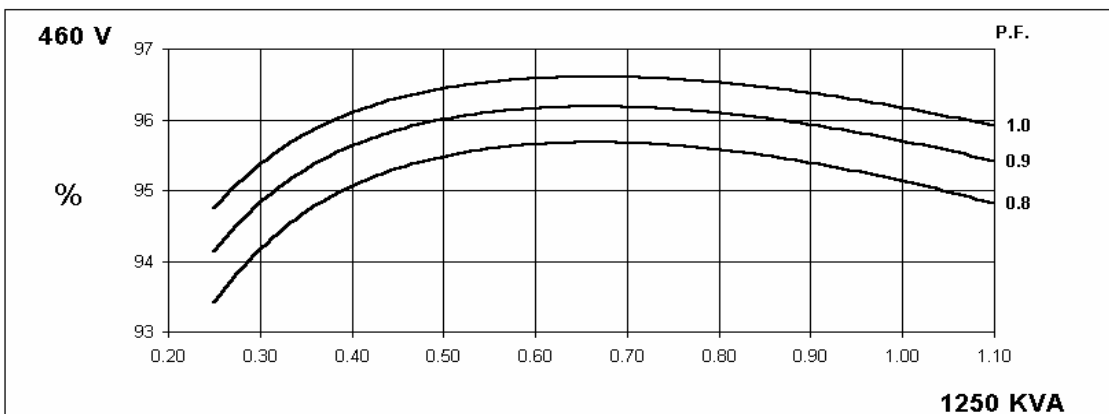
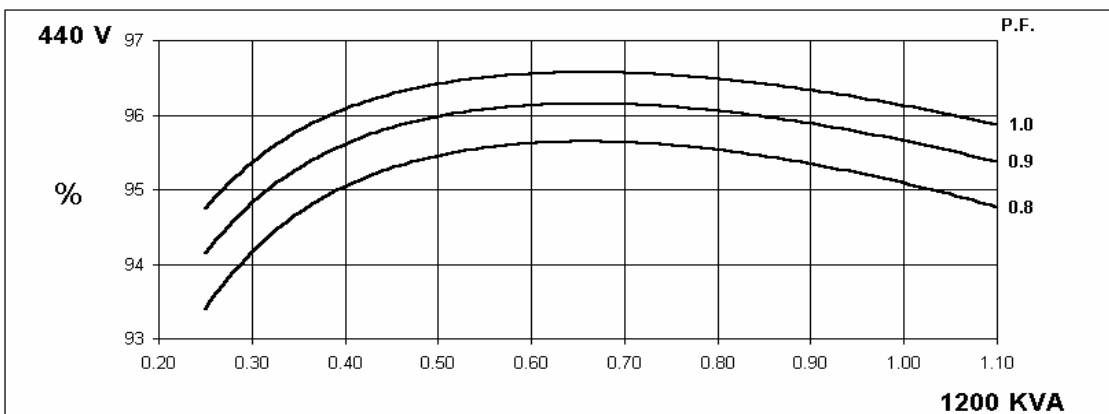
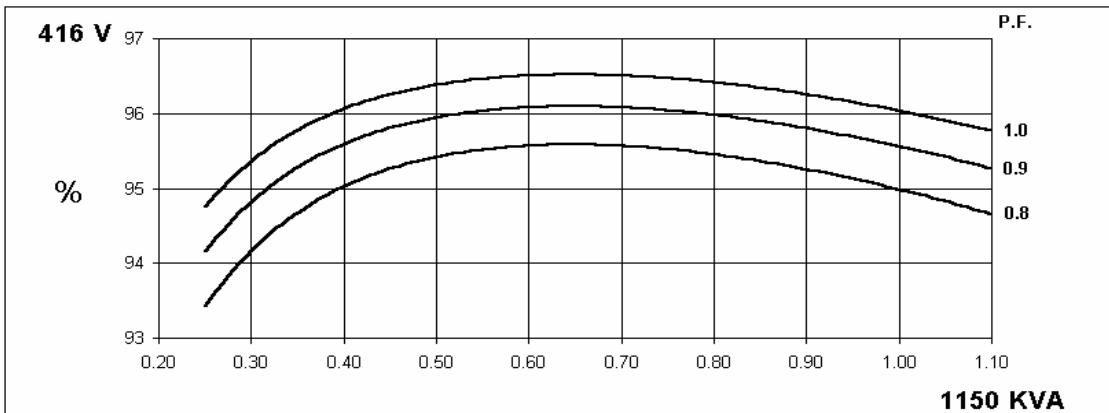

HCI634J

Winding 312



Locked Rotor Motor Starting Curve

**50
Hz**

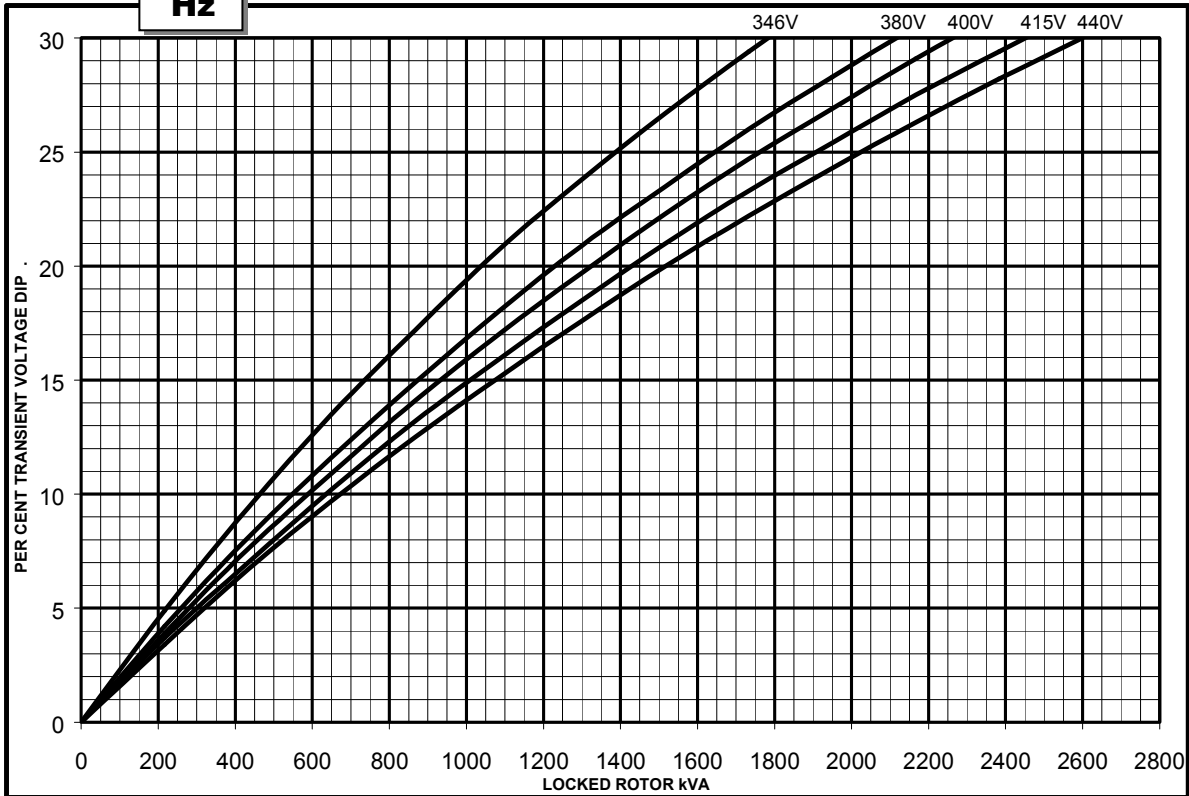

**60
Hz**

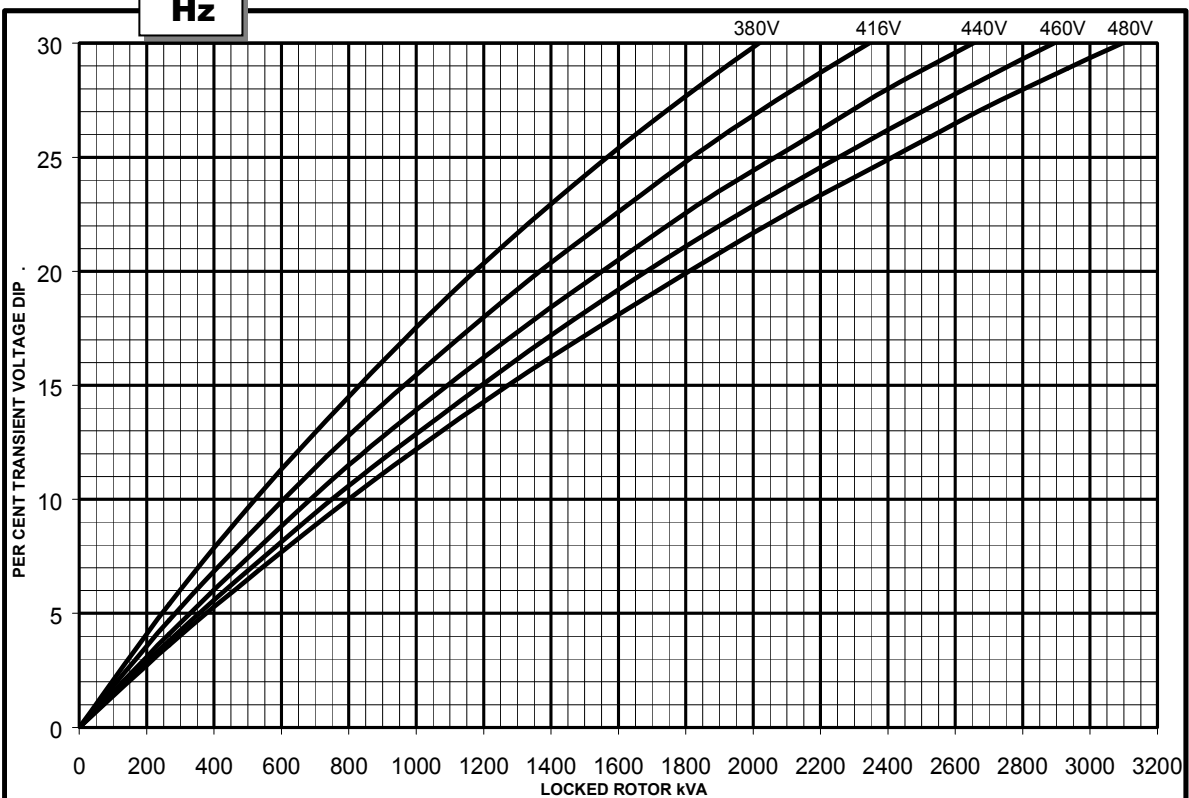

**Three-phase Short Circuit Decrement Curve. No-load Excitation at Rated Speed
Based on star (wye) connection.**

**50
Hz**

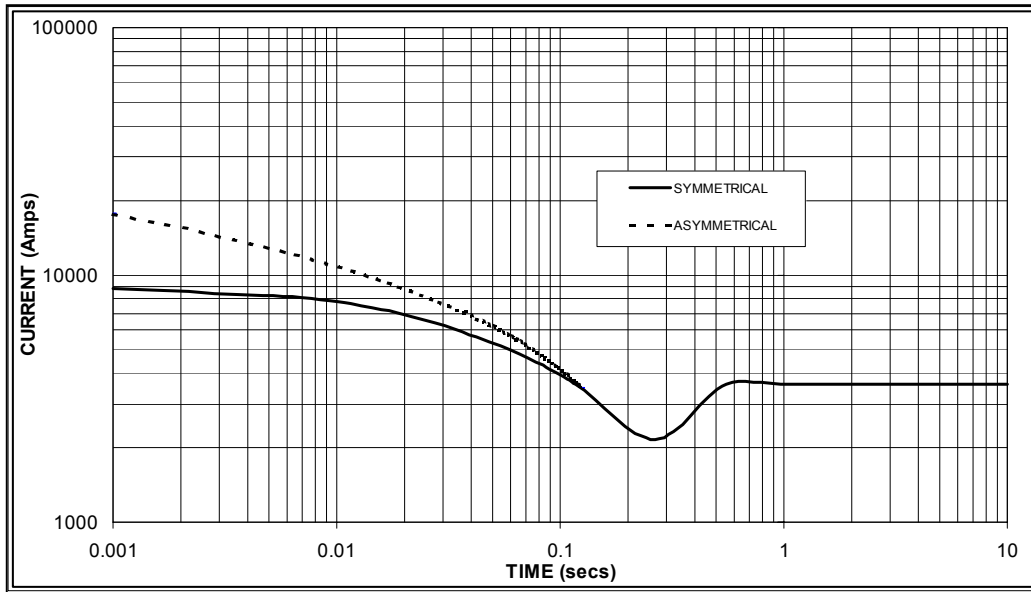

Sustained Short Circuit = 3,600 Amps

**60
Hz**

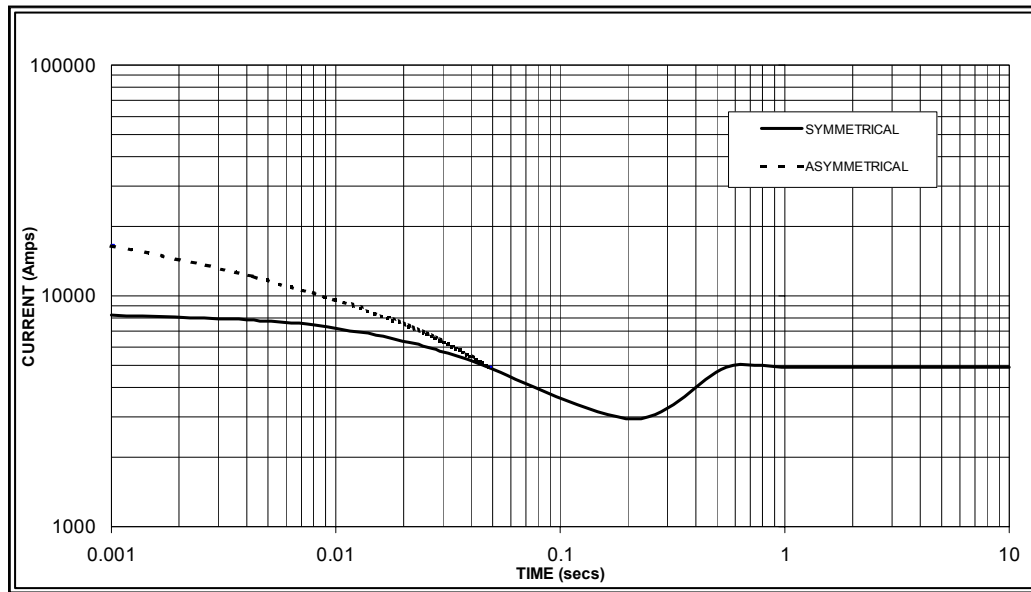

Sustained Short Circuit = 4,900 Amps

Note 1

The following multiplication factors should be used to adjust the values from curve between time 0.001 seconds and the minimum current point in respect of nominal operating voltage :

50Hz		60Hz	
Voltage	Factor	Voltage	Factor
380v	X 1.00	416v	x 1.00
400v	X 1.07	440v	x 1.06
415v	X 1.12	460v	x 1.12
440v	X 1.18	480v	x 1.17

The sustained current value is constant irrespective of voltage level

Note 2

The following multiplication factor should be used to convert the values calculated in accordance with NOTE 1 to those applicable to the various types of short circuit :

	3-phase	2-phase L-L	1-phase L-N
Instantaneous	x 1.00	x 0.87	x 1.30
Minimum	x 1.00	x 1.80	x 3.20
Sustained	x 1.00	x 1.50	x 2.50
Max. sustained duration	10 sec.	5 sec.	2 sec.

All other times are unchanged

Note 3

Curves are drawn for Star (Wye) connected machines.
For Delta connection multiply the Curve current value by 1.732

HCI634J

Winding 312 0.8 Power Factor



RATINGS

Class - Temp Rise		Cont. F - 105/40°C				Cont. H - 125/40°C				Standby - 150/40°C				Standby - 163/27°C			
50Hz	Star (V)	380	400	415	440	380	400	415	440	380	400	415	440	380	400	415	440
	Delta (V)	220	230	240	254	220	230	240	254	220	230	240	254	220	230	240	254
	kVA	900	927	900	900	1000	1030	1000	1000	1060	1070	1060	1060	1100	1110	1100	1100
	kW	720	742	720	720	800	824	800	800	848	856	848	848	880	888	880	880
	Efficiency (%)	95.3	95.4	95.5	95.6	95.0	95.1	95.3	95.4	94.7	94.9	95.1	95.3	94.6	94.8	95.0	95.2
	kW Input	756	777	754	753	842	866	839	839	895	902	892	890	930	937	926	924
60Hz	Star (V)	416	440	460	480	416	440	460	480	416	440	460	480	416	440	460	480
	Delta (V)	240	254	266	277	240	254	266	277	240	254	266	277	240	254	266	277
	kVA	1063	1100	1150	1188	1150	1200	1250	1300	1206	1250	1300	1350	1250	1300	1350	1400
	kW	850	880	920	950	920	960	1000	1040	965	1000	1040	1080	1000	1040	1080	1120
	Efficiency (%)	95.2	95.3	95.3	95.4	95.0	95.1	95.1	95.2	94.8	95.0	95.0	95.1	94.7	94.8	94.9	94.9
	kW Input	893	923	965	996	968	1009	1052	1092	1018	1053	1095	1136	1056	1097	1138	1180

DIMENSIONS

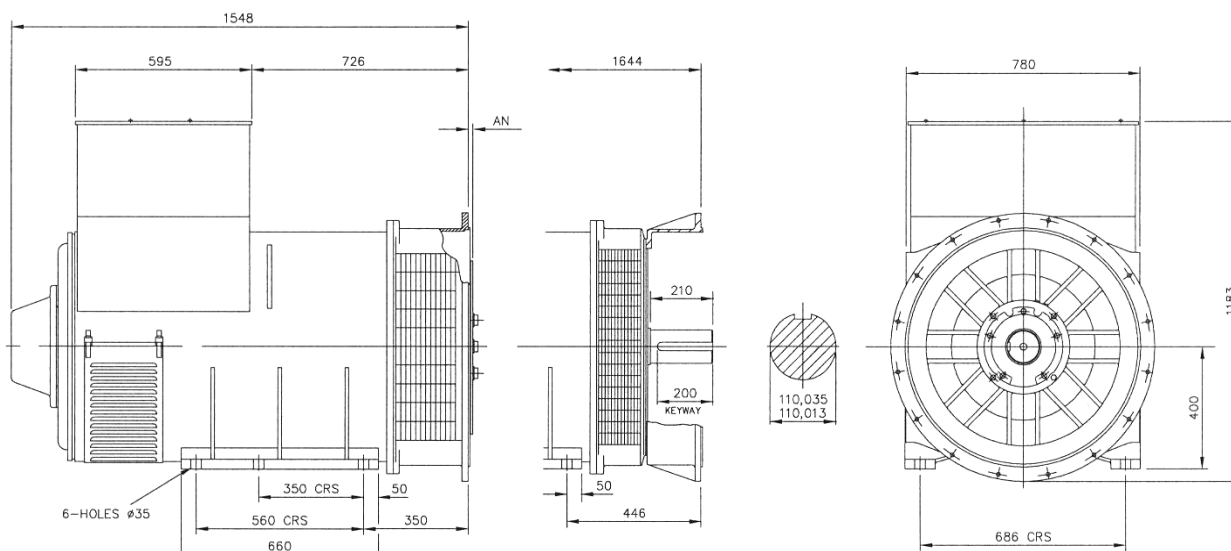

SAE	14	18	21	24
AN	25.4	15.87	0	0



PO Box 17 • Barnack Road • Stamford • Lincolnshire • PE9 2NB

Tel: 00 44 (0)1780 484000 • Fax: 00 44 (0)1780 484100

KTA38-G3



Typical picture

> Specification sheet



Our energy working for you.™

Description

The KTA38-Series benefits from years of technical development and improvement to bring customers an innovative and future proof diesel engine that keeps pace with ever changing generator set requirements.

Recognized globally for its performance under even the most severe climatic conditions, the KTA38-Series is widely acknowledged as the most robust and cost-effective diesel engine in its power range for the generator set market.



This engine has been built to comply with CE certification.



This engine has been designed in facilities certified to ISO9001 and manufactured in facilities certified to ISO9001 or ISO9002.

Features

Aftercooler – Large capacity after cooler results in cooler, denser intake air for more efficient combustion and reduced internal stresses for longer life.

Fuel System - Cummins exclusive low pressure PT™ system with wear compensating pump and integral dual flyweight governor. Camshaft actuated fuel injectors give accurate metering and timing. Fuel lines are internal drilled passages in cylinder heads. Spin-on fuel filter.

Cooling System – Gear driven centrifugal water pump. Large volume water passages provide even flow of coolant around cylinder liners, valves and injectors. Bypass thermostats regulate coolant temperature. Spin-on corrosion resistors check rust and corrosion, control acidity and remove impurities.

Cylinder Block – Alloy cast iron with removable wet liners. Cross bolt support to main bearing cap provides extra strength and stability.

Turbocharger – Cummins Turbo Technologies (CTT) exhaust gas driven turbocharger mounted at top of engine provides more power, improved fuel economy, altitude compensation, and lower smoke and noise levels.

Service and Support - G-Drive products are backed by an uncompromising level of technical support and after sales service, delivered through a world class service network.

1500 rpm (50 Hz Ratings)

Gross Engine Output			Net Engine Output			Typical Generator Set Output					
Standby	Prime	Base	Standby	Prime	Base	Standby (ESP)		Prime (PRP)		Base (COP)	
kWm/BHP			kWm/BHP			kWe	kVA	kWe	kVA	kWe	kVA
895/1200	806/1080	656/880	863/1157	783/1050	633/849	800	1000	728	910	600	750

1800 rpm (60 Hz Ratings)

Gross Engine Output			Net Engine Output			Typical Generator Set Output					
Standby	Prime	Base	Standby	Prime	Base	Standby (ESP)		Prime (PRP)		Base (COP)	
kWm/BHP			kWm/BHP			kWe	kVA	kWe	kVA	kWe	kVA
1000/1340	910/1220	776/1040	952/1276	872/1169	738/989	900	1125	820	1025	700	875



General Engine Data

Type	4 cycle, Turbocharged and After-cooled
Bore mm	159
Stroke mm	159
Displacement Liter	38
Cylinder Block	12-cylinder, direct injection, 4-cycle diesel engine
Battery Charging Alternator	35A
Starting Voltage	24V
Fuel System	Direct injection, EFC (Electric Fuel control) governor
Fuel Filter	Dual spin on paper element fuel filters
Lube Oil Filter Type(s)	Spin on full flow filter
Lube Oil Capacity (l)	140
Flywheel Dimensions	SAE 0

Coolpac Performance Data

Cooling System Design	JWAC		
Coolant Ratio	50% ethylene glycol; 50% water		
Total Coolant Capacity (l)	218.5		
Limiting Ambient Temp (°C)**	50 (50Hz)	56 (60Hz)	
Fan Power (kWm)	20 (50Hz)	35 (60Hz)	
Cooling System Air Flow (m ³ /s)**	18.7 (50Hz)	24.4 (60Hz)	
Air Cleaner Type	Dry replaceable element with restriction indicator		

** @ 13 mm H₂O

Weight & Dimensions

Length	Width	Height	Weight (dry)
mm	mm	mm	kg
3172	1752	2004	4990

Note: Weights represent CoolPac with Light Duty Air Cleaner. See Outline drawings for weights and dimensions for Heavy Duty Air Cleaner configuration.

Fuel Consumption 1500 rpm (50 Hz)

%	kWm	BHP	L/ph	US gal/ph
Standby Power				
100	895	1200	221	58.3
Prime Power				
100	806	1080	198	52.3
75	604	810	151	39.9
50	403	540	104	27.3
25	201	270	54	14.3
Continuous Power				
100	656	880	164	43.3

Fuel Consumption 1800 rpm (60 Hz)

%	kWm	BHP	L/ph	US gal/ph
Standby Power				
100	1000	1340	238	62.9
Prime Power				
100	910	1220	217	57.2
75	683	915	168	44.3
50	455	610	119	31.4
25	228	305	73	19.4
Continuous Power				
100	776	1040	190	50.1

Cummins G-Drive Engines

Asia Pacific

10 Toh Guan Road
#07-01
TT International Tradepark
Singapore 608838
Phone 65 6417 2388
Fax 65 6417 2399

Europe, CIS, Middle East and Africa

Manston Park Columbus Ave
Manston Ramsgate
Kent CT12 5BF. UK
Phone 44 1843 255000
Fax 44 1843 255902

Latin America

Rua Jati, 310, Cumbica
Guarulhos, SP 07180-900
Brazil
Phone 55 11 2186 4552
Fax 55 11 2186 4729

Mexico

Cummins S. de R.L. de C.V.
Eje 122 No. 200 Zona Industrial
San Luis Potosí, S.L.P. 78090
Mexico
Phone 52 444 870 6700
Fax 52 444 870 6811

North America

1400 73rd Avenue N.E.
Minneapolis, MN 55432
USA
Phone 1 763 574 5000
USA Toll-free 1 877 769 7669
Fax 1 763 574 5298

Ratings Definitions

Emergency Standby Power (ESP):

Applicable for supplying power to varying electrical load for the duration of power interruption of a reliable utility source. Emergency Standby Power (ESP) is in accordance with ISO 8528. Fuel Stop power in accordance with ISO 3046, AS 2789, DIN 6271 and BS 5514.

Limited-Time Running Power (LTP):

Applicable for supplying power to a constant electrical load for limited hours. Limited-Time Running Power (LTP) is in accordance with ISO 8528.

Prime Power (PRP):

Applicable for supplying power to varying electrical load for unlimited hours. Prime Power (PRP) is in accordance with ISO 8528. Ten percent overload capability is available in accordance with ISO 3046, AS 2789, DIN 6271 and BS 5514.

Base Load (Continuous) Power (COP):

Applicable for supplying power continuously to a constant electrical load for unlimited hours. Continuous Power (COP) in accordance with ISO 8528, ISO 3046, AS 2789, DIN6271 and BS 5514.





HCI634H - Technical Data Sheet

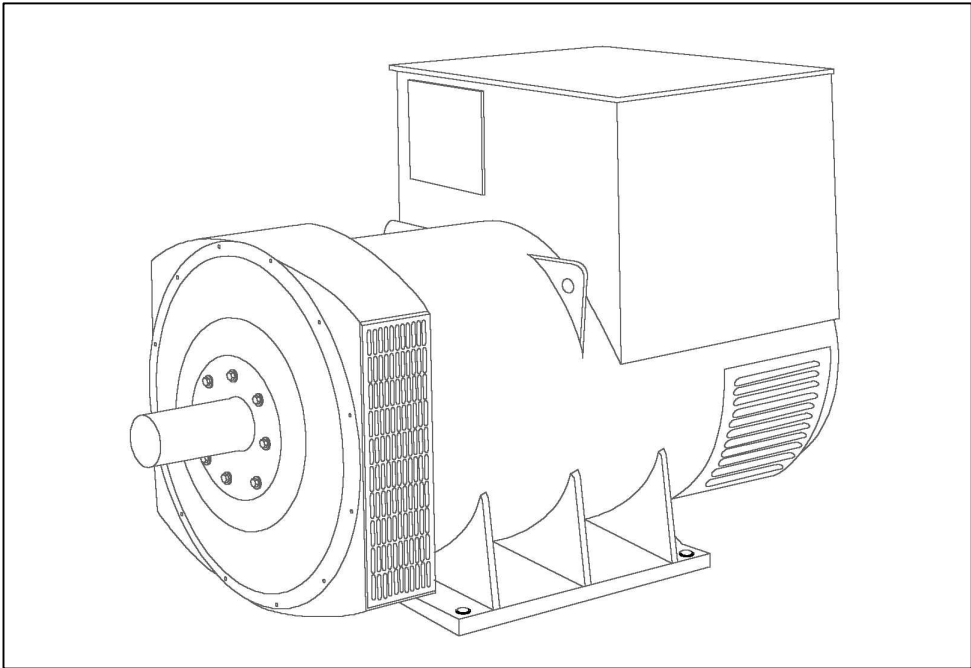

HCI634H

SPECIFICATIONS & OPTIONS



STANDARDS

Newage Stamford industrial generators meet the requirements of BS EN 60034 and the relevant section of other international standards such as BS5000, VDE 0530, NEMA MG1-32, IEC34, CSA C22.2-100, AS1359.

Other standards and certifications can be considered on request.

VOLTAGE REGULATORS

MX321 AVR - STANDARD

This sophisticated Automatic Voltage Regulator (AVR) is incorporated into the Stamford Permanent Magnet Generator (PMG) system and is fitted as standard to generators of this type.

The PMG provides power via the AVR to the main exciter, giving a source of constant excitation power independent of generator output. The main exciter output is then fed to the main rotor, through a full wave bridge, protected by a surge suppressor. The AVR has in-built protection against sustained over-excitation, caused by internal or external faults. This de-excites the machine after a minimum of 5 seconds.

Over voltage protection is built-in and short circuit current level adjustments is an optional facility.

WINDINGS & ELECTRICAL PERFORMANCE

All generator stators are wound to 2/3 pitch. This eliminates triplen (3rd, 9th, 15th ...) harmonics on the voltage waveform and is found to be the optimum design for trouble-free supply of non-linear loads. The 2/3 pitch design avoids excessive neutral currents sometimes seen with higher winding pitches, when in parallel with the mains. A fully connected damper winding reduces oscillations during paralleling. This winding, with the 2/3 pitch and carefully selected pole and tooth designs, ensures very low waveform distortion.

TERMINALS & TERMINAL BOX

Standard generators feature a main stator with 6 ends brought out to the terminals, which are mounted on the frame at the non-drive end of the generator. A sheet steel terminal box contains the AVR and provides ample space for the customers' wiring and gland arrangements. It has removable panels for easy access.

SHAFT & KEYS

All generator rotors are dynamically balanced to better than BS6861:Part 1 Grade 2.5 for minimum vibration in operation. Two bearing generators are balanced with a half key.

INSULATION/IMPREGNATION

The insulation system is class 'H'.

All wound components are impregnated with materials and processes designed specifically to provide the high build required for static windings and the high mechanical strength required for rotating components.

QUALITY ASSURANCE

Generators are manufactured using production procedures having a quality assurance level to BS EN ISO 9001.

The stated voltage regulation may not be maintained in the presence of certain radio transmitted signals. Any change in performance will fall within the limits of Criteria 'B' of EN 61000-6-2:2001. At no time will the steady-state voltage regulation exceed 2%.

NB Continuous development of our products entitles us to change specification details without notice, therefore they must not be regarded as binding.

Front cover drawing typical of product range.

HCI634H
WINDING 312

CONTROL SYSTEM	SEPARATELY EXCITED BY P.M.G.		
A.V.R.	MX321		
VOLTAGE REGULATION	± 0.5 %	With 4% ENGINE GOVERNING	
SUSTAINED SHORT CIRCUIT	REFER TO SHORT CIRCUIT DECREMENT CURVES (page 7)		

INSULATION SYSTEM	CLASS H							
PROTECTION	IP23							
RATED POWER FACTOR	0.8							
STATOR WINDING	DOUBLE LAYER LAP							
WINDING PITCH	TWO THIRDS							
WINDING LEADS	6							
STATOR WDG. RESISTANCE	0.003 Ohms PER PHASE AT 22°C STAR CONNECTED							
ROTOR WDG. RESISTANCE	1.88 Ohms at 22°C							
EXCITER STATOR RESISTANCE	17 Ohms at 22°C							
EXCITER ROTOR RESISTANCE	0.079 Ohms PER PHASE AT 22°C							
R.F.I. SUPPRESSION	BS EN 61000-6-2 & BS EN 61000-6-4, VDE 0875G, VDE 0875N. refer to factory for others							
WAVEFORM DISTORTION	NO LOAD < 1.5% NON-DISTORTING BALANCED LINEAR LOAD < 5.0%							
MAXIMUM OVERSPEED	2250 Rev/Min							
BEARING DRIVE END	BALL. 6224 (ISO)							
BEARING NON-DRIVE END	BALL. 6317 (ISO)							
	1 BEARING				2 BEARING			
WEIGHT COMP. GENERATOR	2117 kg				2145 kg			
WEIGHT WOUND STATOR	1010 kg				1010 kg			
WEIGHT WOUND ROTOR	866 kg				821 kg			
WR ² INERTIA	20.0438 kgm ²				19.4965 kgm ²			
SHIPPING WEIGHTS in a crate	2173kg				2180kg			
PACKING CRATE SIZE	183 x 92 x 140(cm)				183 x 92 x 140(cm)			
	50 Hz				60 Hz			
TELEPHONE INTERFERENCE	THF<2%				TIF<50			
COOLING AIR	1.614 m ³ /sec 3420 cfm				1.961 m ³ /sec 4156 cfm			
VOLTAGE STAR	380/220	400/231	415/240	440/254	416/240	440/254	460/266	480/277
VOLTAGE DELTA	220	230	240	254	240	254	266	277
kVA BASE RATING FOR REACTANCE VALUES	910	910	910	875	1025	1063	1075	1125
X _d DIR. AXIS SYNCHRONOUS	2.99	2.70	2.51	2.15	3.37	3.13	2.89	2.78
X' _d DIR. AXIS TRANSIENT	0.25	0.23	0.21	0.18	0.29	0.27	0.25	0.24
X'' _d DIR. AXIS SUBTRANSIENT	0.18	0.16	0.15	0.13	0.19	0.18	0.17	0.16
X _q QUAD. AXIS REACTANCE	1.77	1.60	1.49	1.27	2.00	1.86	1.72	1.65
X'' _q QUAD. AXIS SUBTRANSIENT	0.19	0.17	0.16	0.14	0.22	0.20	0.19	0.18
X _L LEAKAGE REACTANCE	0.09	0.08	0.07	0.06	0.10	0.09	0.08	0.08
X ₂ NEGATIVE SEQUENCE	0.20	0.18	0.17	0.14	0.23	0.21	0.20	0.19
X ₀ ZERO SEQUENCE	0.03	0.02	0.02	0.02	0.03	0.03	0.02	0.02
REACTANCES ARE SATURATED				VALUES ARE PER UNIT AT RATING AND VOLTAGE INDICATED				
T' _d TRANSIENT TIME CONST.	0.185							
T'' _d SUB-TRANSTIME CONST.	0.025							
T' _{do} O.C. FIELD TIME CONST.	2.44							
T _a ARMATURE TIME CONST.	0.04							
SHORT CIRCUIT RATIO	1/X _d							

**50
Hz**

HCI634H
Winding 312



THREE PHASE EFFICIENCY CURVES

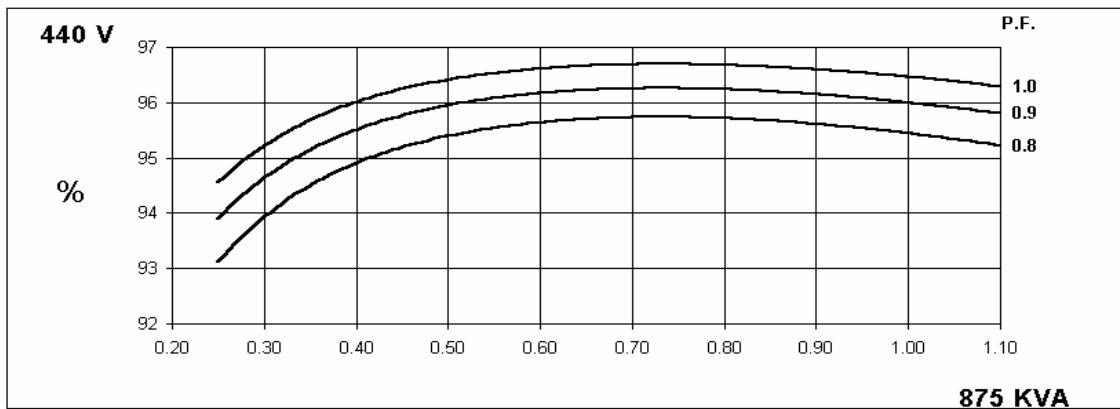
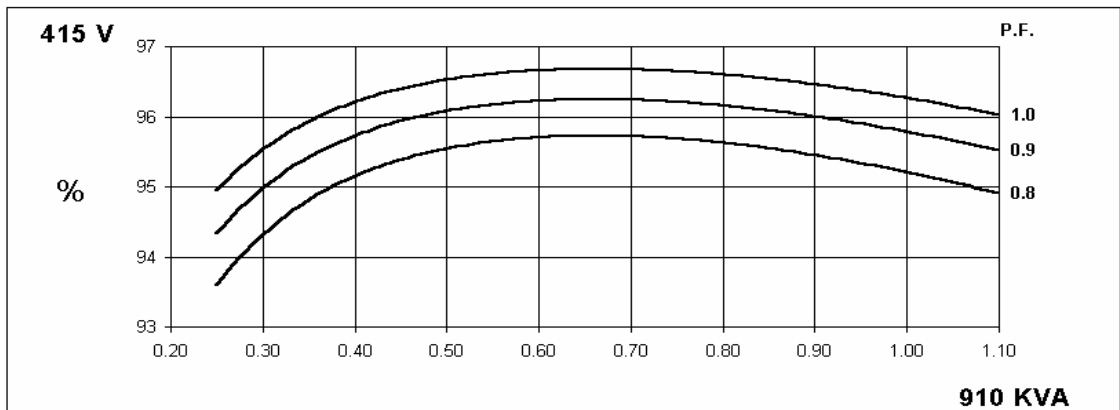
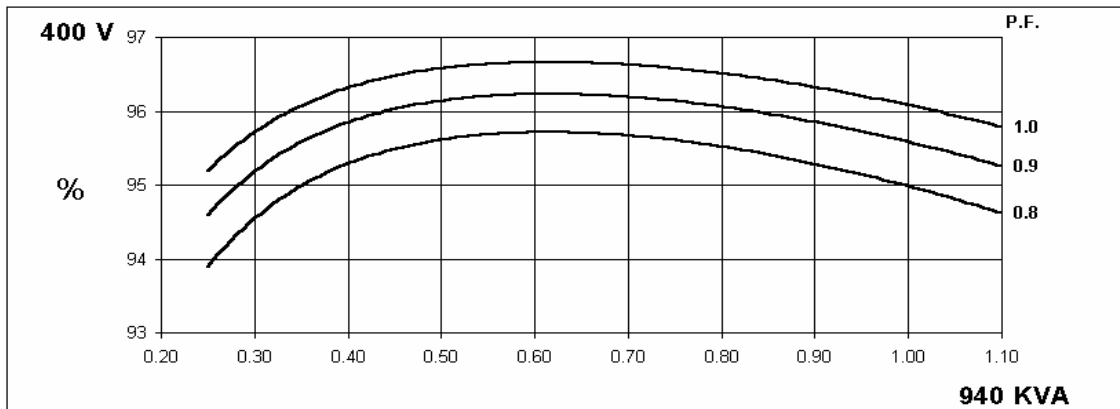
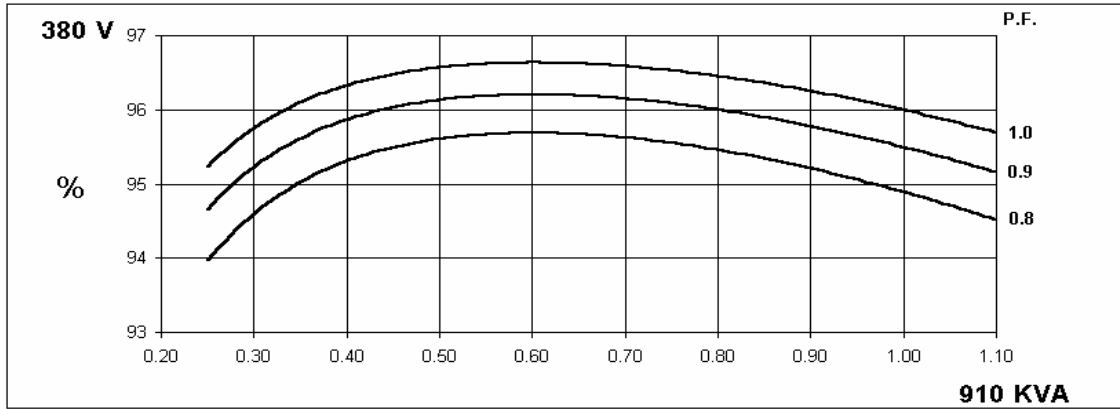

THREE PHASE EFFICIENCY CURVES

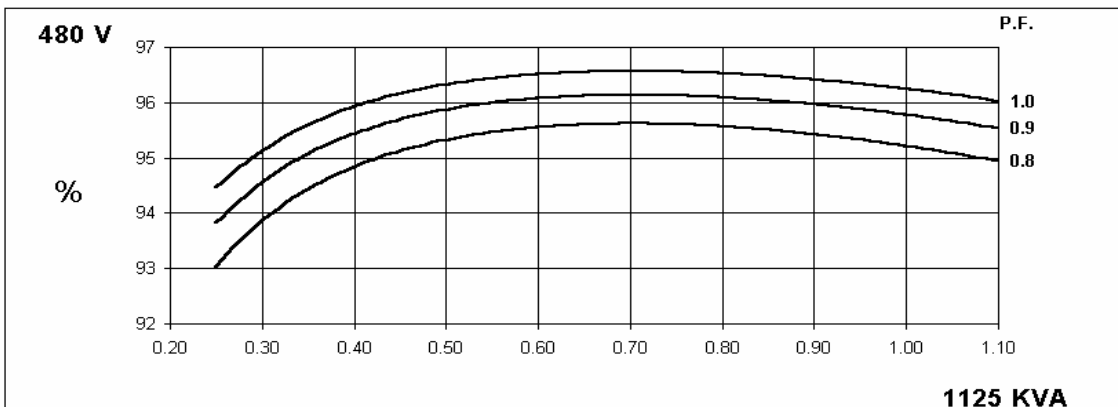
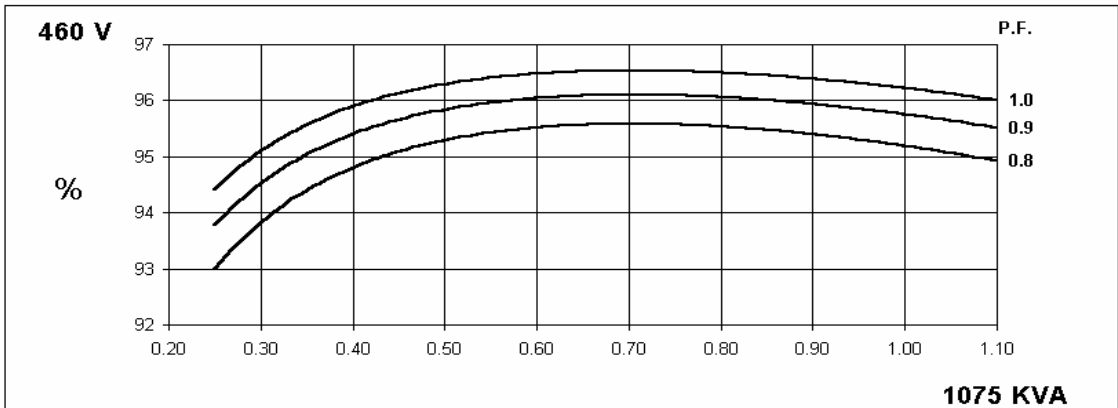
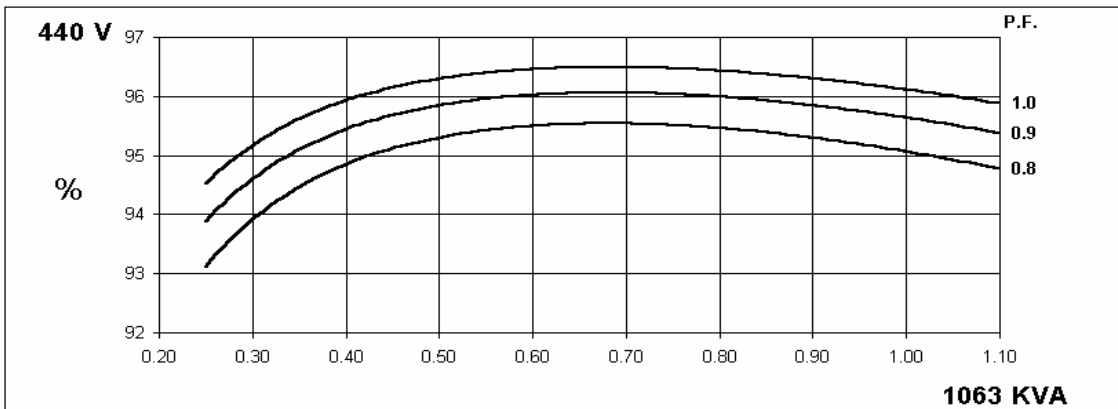
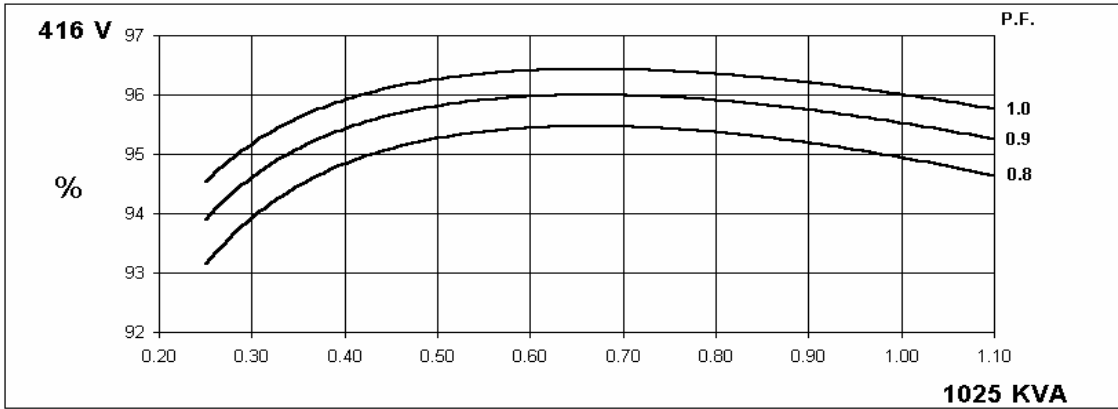

HCI634H

Winding 312



Locked Rotor Motor Starting Curve

**50
Hz**

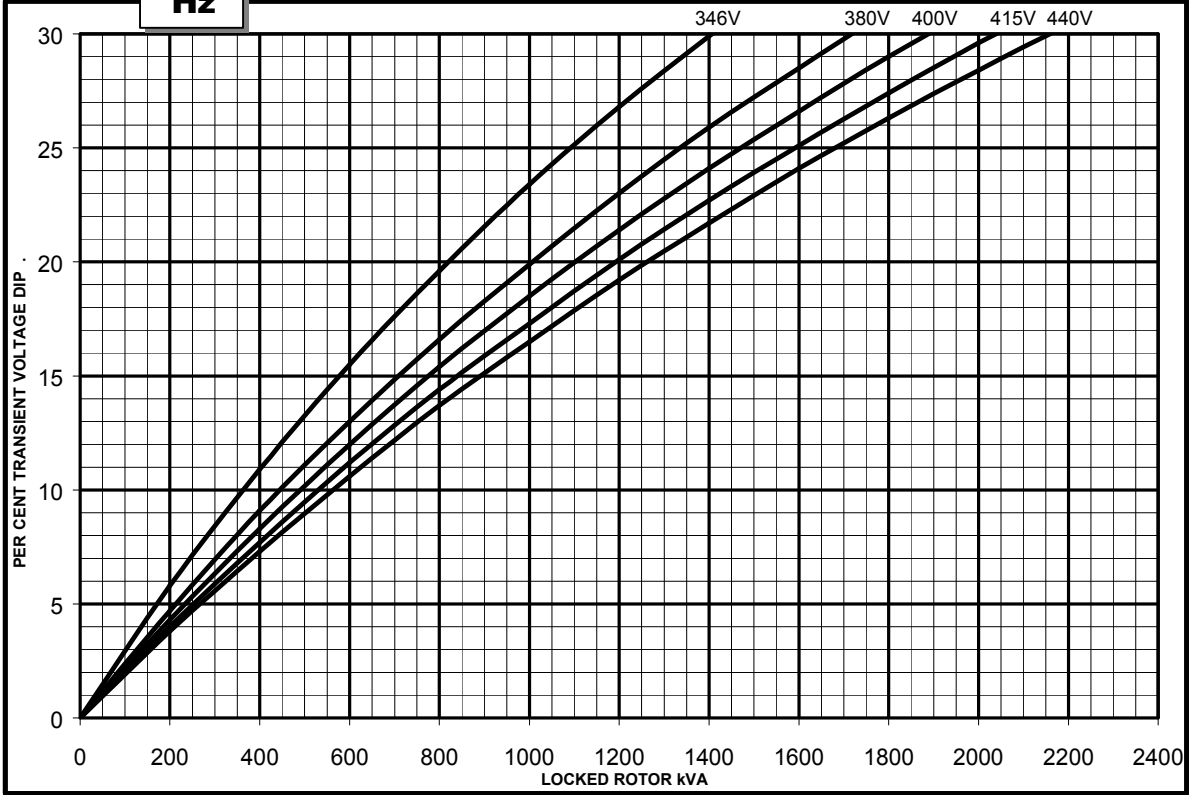

**60
Hz**

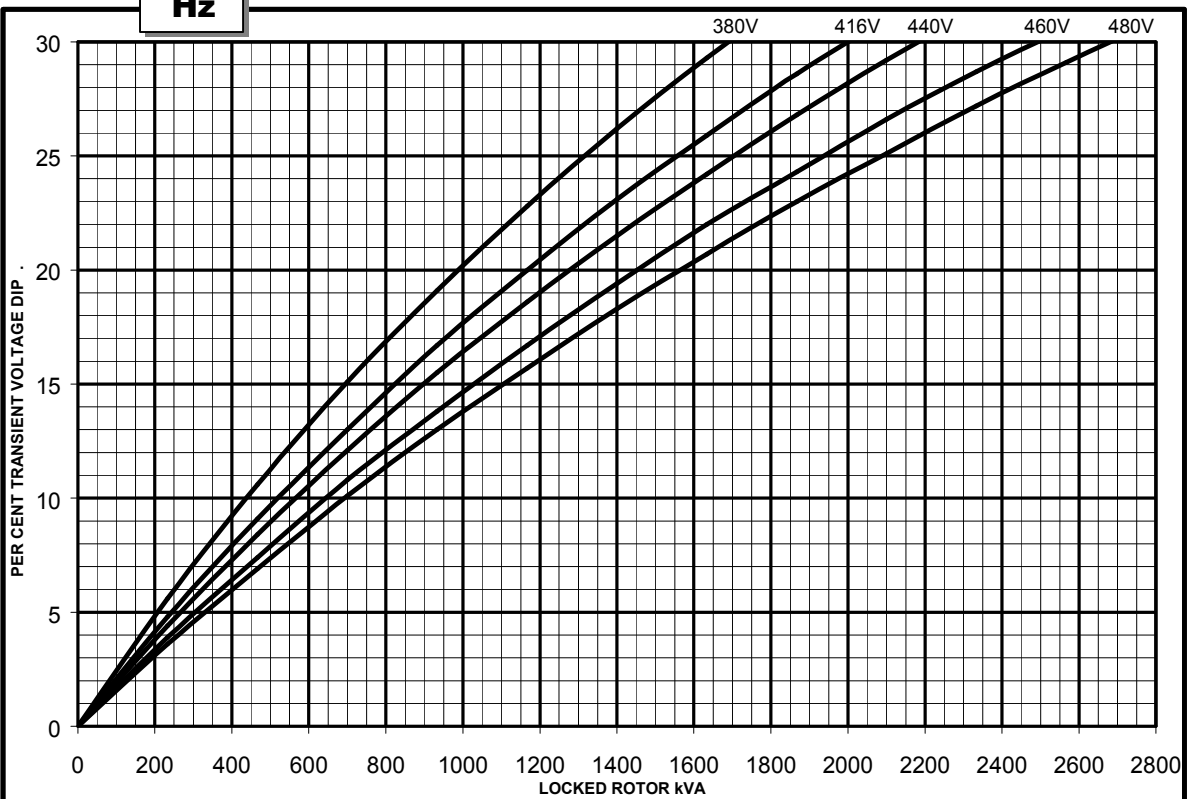

**Three-phase Short Circuit Decrement Curve. No-load Excitation at Rated Speed
Based on star (wye) connection.**

**50
Hz**

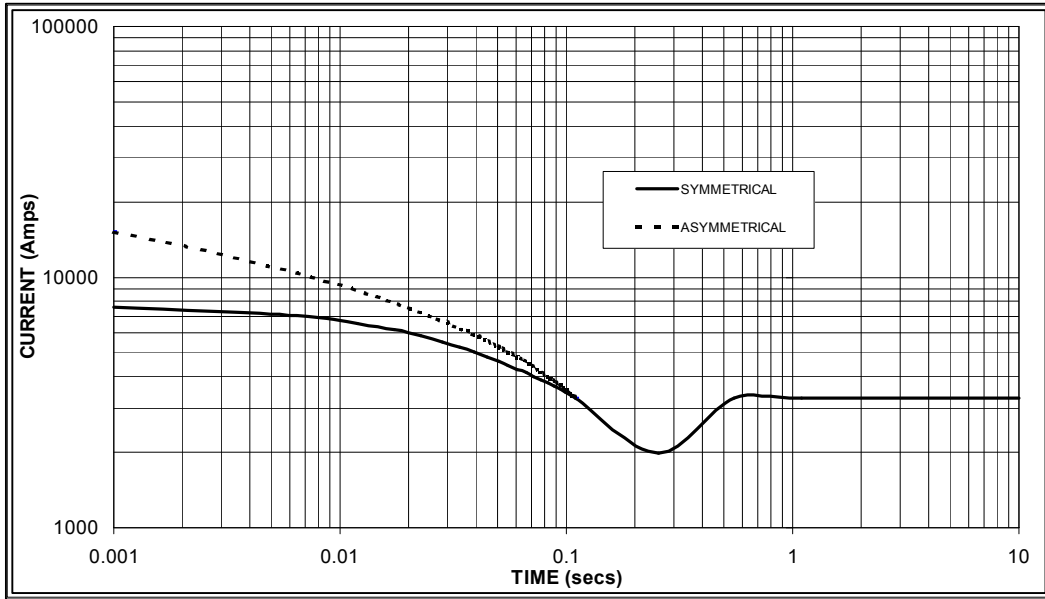

Sustained Short Circuit = 3,300 Amps

**60
Hz**

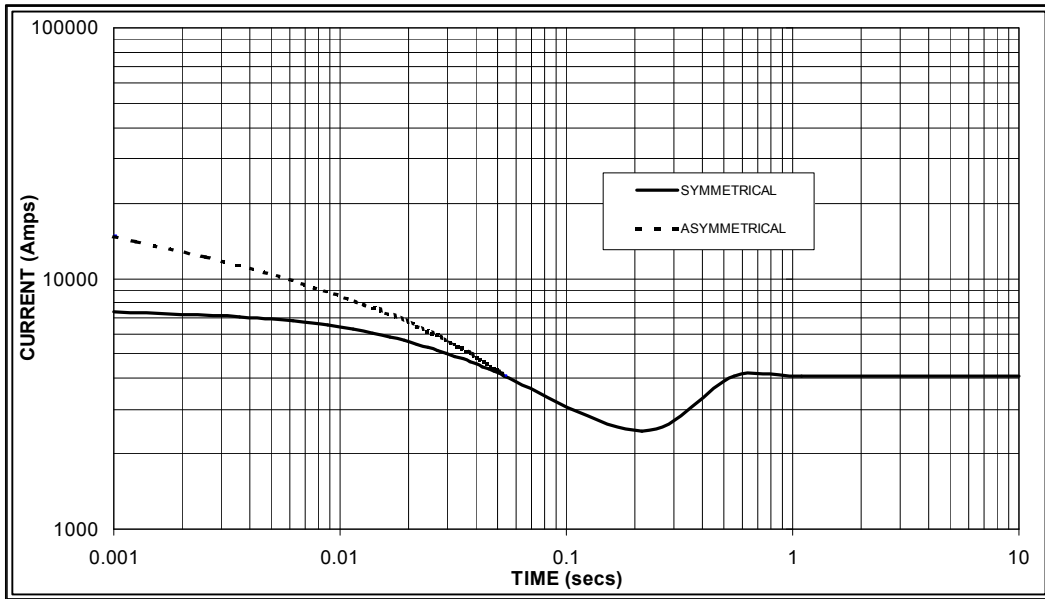

Sustained Short Circuit = 4,000 Amps

Note 1

The following multiplication factors should be used to adjust the values from curve between time 0.001 seconds and the minimum current point in respect of nominal operating voltage :

50Hz		60Hz	
Voltage	Factor	Voltage	Factor
380v	X 1.00	416v	x 1.00
400v	X 1.07	440v	x 1.06
415v	X 1.12	460v	x 1.12
440v	X 1.18	480v	x 1.17

The sustained current value is constant irrespective of voltage level

Note 2

The following multiplication factor should be used to convert the values calculated in accordance with NOTE 1 to those applicable to the various types of short circuit :

	3-phase	2-phase L-L	1-phase L-N
Instantaneous	x 1.00	x 0.87	x 1.30
Minimum	x 1.00	x 1.80	x 3.20
Sustained	x 1.00	x 1.50	x 2.50
Max. sustained duration	10 sec.	5 sec.	2 sec.

All other times are unchanged

Note 3

Curves are drawn for Star (Wye) connected machines.

HCI634H

Winding 312 0.8 Power Factor



RATINGS

Class - Temp Rise	Cont. F - 105/40°C				Cont. H - 125/40°C				Standby - 150/40°C				Standby - 163/27°C				
50Hz	Star (V)	380	400	415	440	380	400	415	440	380	400	415	440	380	400	415	440
	Delta (V)	220	230	240	254	220	230	240	254	220	230	240	254	220	230	240	254
	kVA	830	860	830	800	910	940	910	875	960	980	960	920	1000	1010	1000	960
	kW	664	688	664	640	728	752	728	700	768	784	768	736	800	808	800	768
	Efficiency (%)	95.2	95.3	95.4	95.6	94.9	95.0	95.2	95.4	94.7	94.8	95.1	95.3	94.5	94.7	94.9	95.2
	kW Input	697	722	696	669	767	792	765	734	811	827	808	772	847	853	843	807

60Hz	Star (V)	416	440	460	480	416	440	460	480	416	440	460	480	416	440	460	480
	Delta (V)	240	254	266	277	240	254	266	277	240	254	266	277	240	254	266	277
	kVA	913	963	1000	1025	1025	1063	1075	1125	1088	1125	1138	1188	1125	1163	1175	1219
	kW	730	770	800	820	820	850	860	900	870	900	910	950	900	930	940	975
	Efficiency (%)	95.2	95.3	95.3	95.4	94.9	95.1	95.2	95.2	94.8	94.9	95.0	95.1	94.6	94.8	94.9	95.0
	kW Input	767	808	839	860	864	894	903	945	918	948	958	999	951	981	991	1027

DIMENSIONS

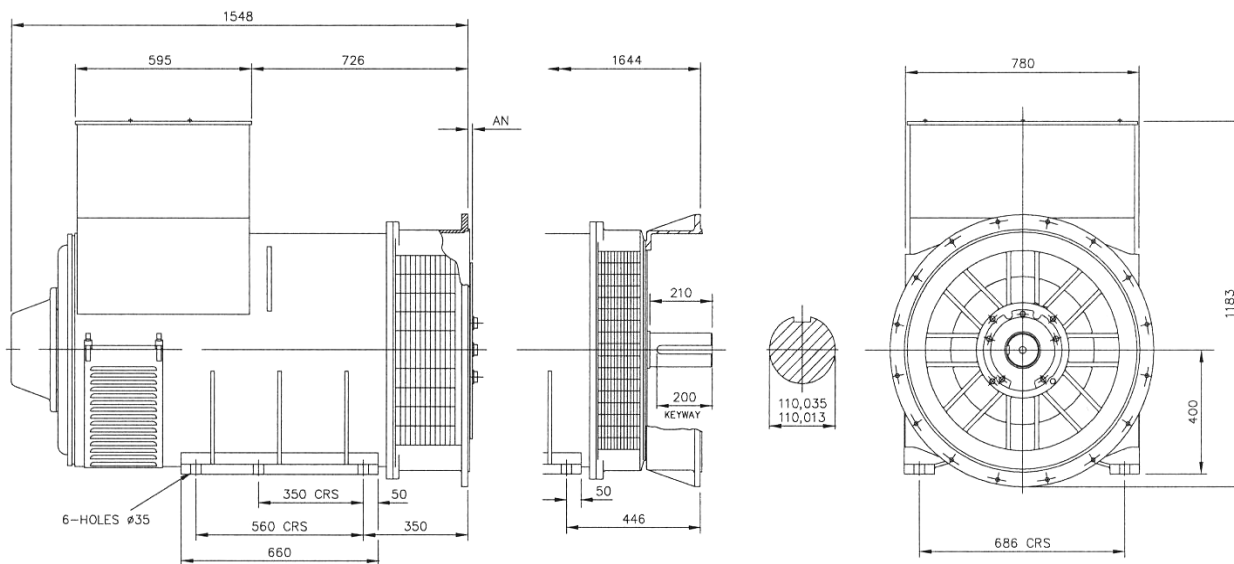

SAE	14	18	21	24
AN	25.4	15.87	0	0



Barnack Road • Stamford • Lincolnshire • PE9 2NB
 Tel: 00 44 (0)1780 484000 • Fax: 00 44 (0)1780 484100

KTA19-G4

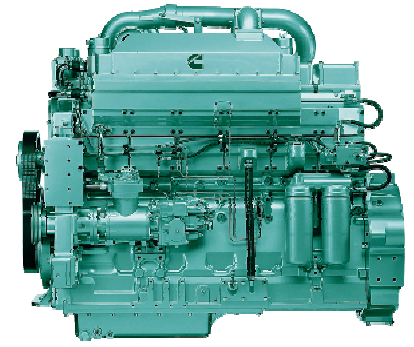

> Specification sheet



Our energy working for you.™

Description

The KTA19-Series benefits from years of technical development and improvement to bring customers an innovative and future proof diesel engine that keeps pace with ever changing generator set requirements.

Recognised globally for its performance under even the most severe climatic conditions, the KTA19-Series is widely acknowledged as the most robust and cost-effective diesel engine in its power range for the generator set market.



This engine has been built to comply with CE certification.



This engine has been designed in facilities certified to ISO9001 and manufactured in facilities certified to ISO9001 or ISO9002.

Features

Turbocharger – Cummins Turbo technologies (CTT) exhaust gas driven turbocharger mounted at top of engine.

Fuel System – Cummins PT™ self-adjusting system. Integral dual flyweight governor provides overspeed protection independent of main governor.

Aftercooler – Large capacity aftercooler results in cooler, denser intake air for more efficient combustion and reduced internal stresses for longer life.

Cylinder Block – Alloy cast iron with removable wet liners. Cross bolt support to main bearing cap provides extra strength and stability.

Service and Support - G-Drive products are backed by an uncompromising level of technical support and after sales service, delivered through a world class service network.

1500 rpm (50 Hz Ratings)

Gross Engine Output			Net Engine Output			Typical Generator Set Output					
Standby	Prime	Base	Standby	Prime	Base	Standby (ESP)		Prime (PRP)		Base (COP)	
kWm/BHP			kWm/BHP			kWe	kVA	kWe	kVA	kWe	kVA
504/675	488/600	355/475	479/642	428/573	335/449	440	550	400	500	315	393

1800 rpm (60 Hz Ratings)

Gross Engine Output			Net Engine Output			Typical Generator Set Output					
Standby	Prime	Base	Standby	Prime	Base	Standby (ESP)		Prime (PRP)		Base (COP)	
kWm/BHP			kWm/BHP			kWe	kVA	kWe	kVA	kWe	kVA
563/755	507/680	429/575	520/697	470/630	392/525	500	625	455	569	368	460



General Engine Data

Type	4 cycle, in-line, Turbo Charged
Bore mm	159
Stroke mm	159
Displacement Litre	18.9 litre
Cylinder Block	Cast iron, 6 cylinder
Battery Charging Alternator	35A
Starting Voltage	24V
Fuel System	Direct injection
Fuel Filter	Spin-on fuel filters with water separator
Lube Oil Filter Type(s)	Spin-on full flow filter
Lube Oil Capacity (l)	50
Flywheel Dimensions	SAE 0

Coolpac Performance Data

Cooling System Design	Jacket Water After Cooled
Coolant Ratio	50% ethylene glycol; 50% water
Coolant Capacity (l)	Engine only – not applicable
Limiting Ambient Temp (°C)**	
Fan Power (kWm)	
Cooling System Air Flow (m ³ /s)**	
Air Cleaner Type	Dry replaceable element with restriction indicator

** @ 13 mm H₂O

Ratings Definitions

Emergency Standby Power (ESP):

Applicable for supplying power to varying electrical load for the duration of power interruption of a reliable utility source. Emergency Standby Power (ESP) is in accordance with ISO 8528. Fuel Stop power in accordance with ISO 3046, AS 2789, DIN 6271 and BS 5514.

Limited-Time Running Power (LTP):

Applicable for supplying power to a constant electrical load for limited hours. Limited-Time Running Power (LTP) is in accordance with ISO 8528.

Prime Power (PRP):

Applicable for supplying power to varying electrical load for unlimited hours. Prime Power (PRP) is in accordance with ISO 8528. Ten percent overload capability is available in accordance with ISO 3046, AS 2789, DIN 6271 and BS 5514.

Base Load (Continuous) Power (COP):

Applicable for supplying power continuously to a constant electrical load for unlimited hours. Continuous Power (COP) in accordance with ISO 8528, ISO 3046, AS 2789, DIN6271 and BS 5514.

Weight & Dimensions

Length	Width	Height	Weight (dry)
mm	mm	mm	kg
1859	868	1728	1855

Fuel Consumption 1500 rpm (50 Hz)

%	kWm	BHP	L/ph	US gal/ph
Standby Power				
100	504	675	121	31.9
Prime Power				
100	448	600	107	28.4
75	336	450	82	21.6
50	224	300	57	14.9
25	112	150	30	8.1
Continuous Power				
100	355	475	86	22.8

Fuel Consumption 1800 rpm (60 Hz)

%	kWm	BHP	L/ph	US gal/ph
Standby Power				
100	563	755	136	35.9
Prime Power				
100	507	680	122	32.3
75	380	510	94	24.8
50	254	340	65	17
25	127	170	36	9.6
Continuous Power				
100	429	575	104	27.3

Cummins G-Drive Engines

Asia Pacific

10 Toh Guan Road
#07-01
TT International Tradepark
Singapore 608838
Phone 65 6417 2388
Fax 65 6417 2399

Europe, CIS, Middle

East and Africa
Manston Park Columbus Ave
Manston Ramsgate
Kent CT12 5BF. UK
Phone 44 1843 255000
Fax 44 1843 255902

Latin America

Rua Jati, 310, Cumbica
Guarulhos, SP 07180-900
Brazil
Phone 55 11 2186 4552
Fax 55 11 2186 4729

Mexico

Cummins S. de R.L. de C.V.
Eje 122 No. 200 Zona Industrial
San Luis Potosi, S.L.P. 78090
Mexico
Phone 52 444 870 6700
Fax 52 444 870 6811

North America

1400 73rd Avenue N.E.
Minneapolis, MN 55432
USA
Phone 1 763 574 5000
USA Toll-free 1 877 769 7669
Fax 1 763 574 5298



HCI 534D/544D - Technical Data Sheet

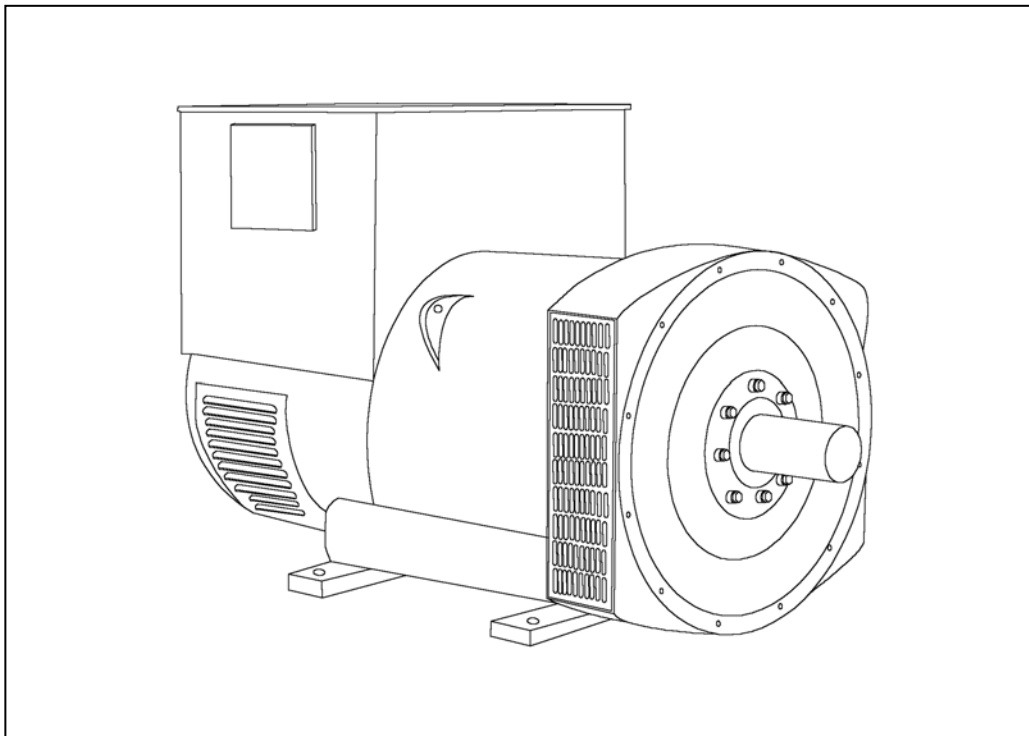

HCI534D/544D

SPECIFICATIONS & OPTIONS



STANDARDS

Newage Stamford industrial generators meet the requirements of BS EN 60034 and the relevant section of other international standards such as BS5000, VDE 0530, NEMA MG1-32, IEC34, CSA C22.2-100, AS1359. Other standards and certifications can be considered on request.

VOLTAGE REGULATORS

SX440 AVR - STANDARD

With this self-excited system the main stator provides power via the Automatic Voltage Regulator (AVR) to the exciter stator. The high efficiency semi-conductors of the AVR ensure positive build-up from initial low levels of residual voltage.

The exciter rotor output is fed to the main rotor through a three-phase full-wave bridge rectifier. The rectifier is protected by a surge suppressor against surges caused, for example, by short circuit or out-of-phase paralleling.

The SX440 will support a range of electronic accessories, including a 'droop' Current Transformer (CT) to permit parallel operation with other ac generators.

If 3-phase sensing is required with the self-excited system, the SX421 AVR must be used.

SX421 AVR

This AVR also operates in a self-excited system. It combines all the features of the SX440 with, additionally, three-phase rms sensing for improved regulation and performance. Over voltage protection is provided via a separate circuit breaker. An engine relief load acceptance feature is built in as standard.

MX341 AVR

This sophisticated AVR is incorporated into the Stamford Permanent Magnet Generator (PMG) control system.

The PMG provides power via the AVR to the main exciter, giving a source of constant excitation power independent of generator output. The main exciter output is then fed to the main rotor, through a full wave bridge, protected by a surge suppressor. The AVR has in-built protection against sustained over-excitation, caused by internal or external faults. This de-excites the machine after a minimum of 5 seconds.

An engine relief load acceptance feature can enable full load to be applied to the generator in a single step.

If three-phase sensing is required with the PMG system the MX321 AVR must be used.

We recommend three-phase sensing for applications with greatly unbalanced or highly non-linear loads.

MX321 AVR

The most sophisticated of all our AVRs combines all the features of the MX341 with, additionally, three-phase rms sensing, for improved regulation and performance.

Over voltage protection is built-in and short circuit current level adjustments is an optional facility.

WINDINGS & ELECTRICAL PERFORMANCE

All generator stators are wound to 2/3 pitch. This eliminates triplen (3rd, 9th, 15th ...) harmonics on the voltage waveform and is found to be the optimum design for trouble-free supply of non-linear loads. The 2/3 pitch design avoids excessive neutral currents sometimes seen with higher winding pitches, when in parallel with the mains. A fully connected damper winding reduces oscillations during paralleling. This winding, with the 2/3 pitch and carefully selected pole and tooth designs, ensures very low waveform distortion.

TERMINALS & TERMINAL BOX

Standard generators are 3-phase reconnectable with 12 ends brought out to the terminals, which are mounted on a cover at the non-drive end of the generator. A sheet steel terminal box contains the AVR and provides ample space for the customers' wiring and gland arrangements. It has removable panels for easy access.

SHAFT & KEYS

All generator rotors are dynamically balanced to better than BS6861:Part 1 Grade 2.5 for minimum vibration in operation. Two bearing generators are balanced with a half key.

INSULATION/IMPREGNATION

The insulation system is class 'H'.

All wound components are impregnated with materials and processes designed specifically to provide the high build required for static windings and the high mechanical strength required for rotating components.

QUALITY ASSURANCE

Generators are manufactured using production procedures having a quality assurance level to BS EN ISO 9001.

The stated voltage regulation may not be maintained in the presence of certain radio transmitted signals. Any change in performance will fall within the limits of Criteria 'B' of EN 61000-6-2:2001. At no time will the steady-state voltage regulation exceed 2%.

NB Continuous development of our products entitles us to change specification details without notice, therefore they must not be regarded as binding.

Front cover drawing typical of product range.

HCI534D/544D

WINDING 311

CONTROL SYSTEM	SEPARATELY EXCITED BY P.M.G.							
A.V.R.	MX321	MX341						
VOLTAGE REGULATION	± 0.5 %	± 1.0 %	With 4% ENGINE GOVERNING					
SUSTAINED SHORT CIRCUIT	REFER TO SHORT CIRCUIT DECREMENT CURVES (page 7)							
CONTROL SYSTEM	SELF EXCITED							
A.V.R.	SX440	SX421						
VOLTAGE REGULATION	± 1.0 %	± 0.5 %	With 4% ENGINE GOVERNING					
SUSTAINED SHORT CIRCUIT	SERIES 4 CONTROL DOES NOT SUSTAIN A SHORT CIRCUIT CURRENT							
INSULATION SYSTEM	CLASS H							
PROTECTION	IP23							
RATED POWER FACTOR	0.8							
STATOR WINDING	DOUBLE LAYER LAP							
WINDING PITCH	TWO THIRDS							
WINDING LEADS	12							
STATOR WDG. RESISTANCE	0.005 Ohms PER PHASE AT 22°C SERIES STAR CONNECTED							
ROTOR WDG. RESISTANCE	1.77 Ohms at 22°C							
R.F.I. SUPPRESSION	BS EN 61000-6-2 & BS EN 61000-6-4,VDE 0875G, VDE 0875N. refer to factory for others							
WAVEFORM DISTORTION	NO LOAD < 1.5% NON-DISTORTING BALANCED LINEAR LOAD < 5.0%							
MAXIMUM OVERSPEED	2250 Rev/Min							
BEARING DRIVE END	BALL. 6220 (ISO)							
BEARING NON-DRIVE END	BALL. 6314 (ISO)							
	1 BEARING				2 BEARING			
WEIGHT COMP. GENERATOR	1393 kg				1395 kg			
WEIGHT WOUND STATOR	657 kg				657 kg			
WEIGHT WOUND ROTOR	563 kg				535 kg			
WR ² INERTIA	8.0068 kgm ²				7.7289 kgm ²			
SHIPPING WEIGHTS in a crate	1485 kg				1485 kg			
PACKING CRATE SIZE	166 x 87 x 124(cm)				166 x 87 x 124(cm)			
	50 Hz				60 Hz			
TELEPHONE INTERFERENCE	THF<2%				TIF<50			
COOLING AIR	1.035 m ³ /sec 2202 cfm				1.312 m ³ /sec 2780 cfm			
VOLTAGE SERIES STAR	380/220	400/231	415/240	440/254	416/240	440/254	460/266	480/277
VOLTAGE PARALLEL STAR	190/110	200/115	208/120	220/127	208/120	220/127	230/133	240/138
VOLTAGE SERIES DELTA	220/110	230/115	240/120	254/127	240/120	254/127	266/133	277/138
KVA BASE RATING FOR REACTANCE VALUES	500	500	500	500	575	594	625	644
X _d DIR. AXIS SYNCHRONOUS	3.02	2.72	2.53	2.25	3.52	3.25	3.13	2.96
X' _d DIR. AXIS TRANSIENT	0.16	0.14	0.13	0.12	0.17	0.16	0.15	0.14
X'' _d DIR. AXIS SUBTRANSIENT	0.11	0.10	0.09	0.08	0.12	0.11	0.11	0.10
X _q QUAD. AXIS REACTANCE	2.48	2.24	2.08	1.85	2.87	2.65	2.55	2.41
X'' _q QUAD. AXIS SUBTRANSIENT	0.27	0.25	0.23	0.20	0.31	0.29	0.28	0.26
X _L LEAKAGE REACTANCE	0.05	0.04	0.04	0.04	0.06	0.06	0.05	0.05
X ₂ NEGATIVE SEQUENCE	0.19	0.17	0.16	0.14	0.22	0.20	0.20	0.19
X ₀ ZERO SEQUENCE	0.10	0.09	0.08	0.07	0.10	0.09	0.09	0.08
REACTANCES ARE SATURATED VALUES ARE PER UNIT AT RATING AND VOLTAGE INDICATED								
T' _d TRANSIENT TIME CONST.	0.08s							
T'' _d SUB-TRANSTIME CONST.	0.012s							
T' _{do} O.C. FIELD TIME CONST.	2.2s							
T _a ARMATURE TIME CONST.	0.018s							
SHORT CIRCUIT RATIO	1/X _d							

**50
Hz**

HCI534D/544D
Winding 311



THREE PHASE EFFICIENCY CURVES

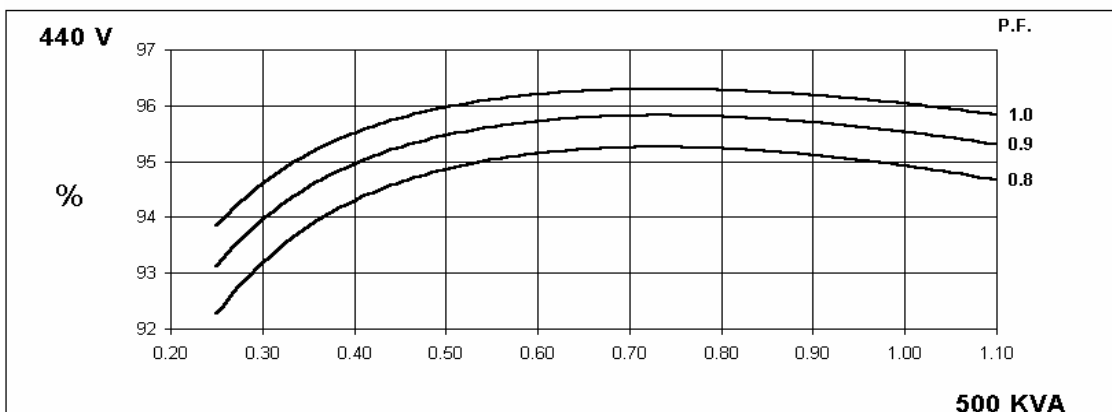
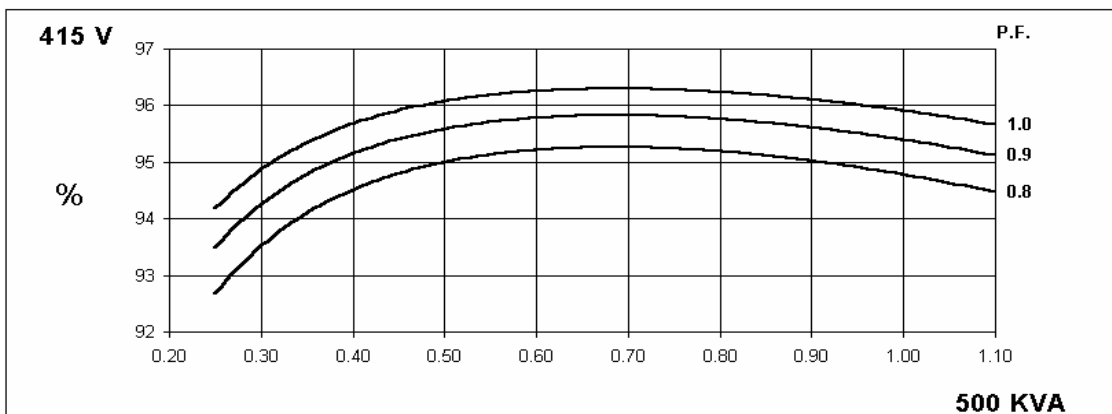
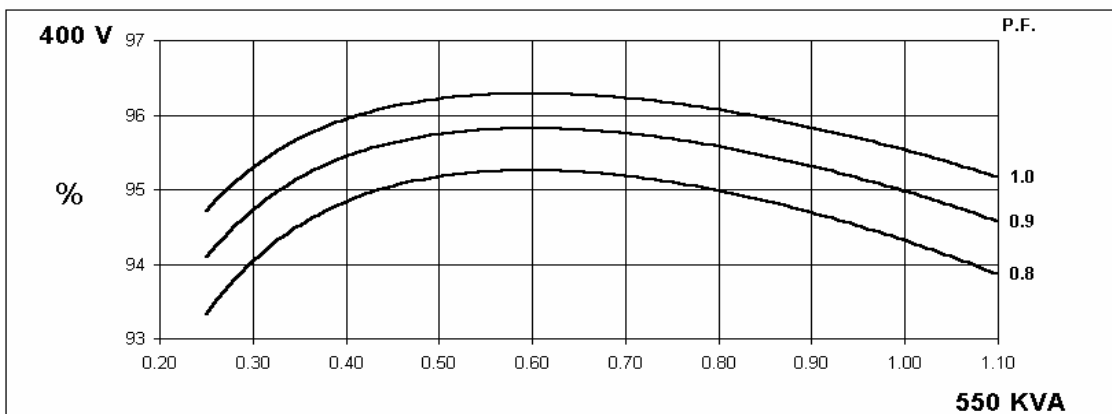
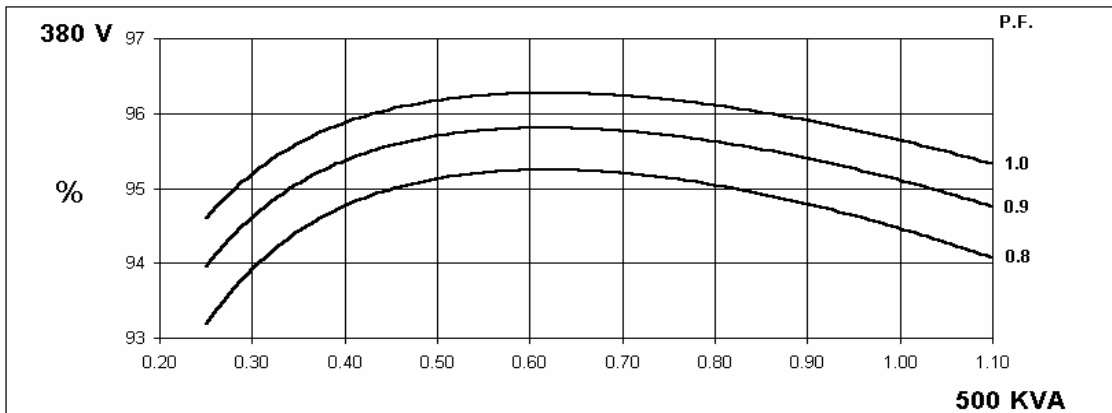

THREE PHASE EFFICIENCY CURVES

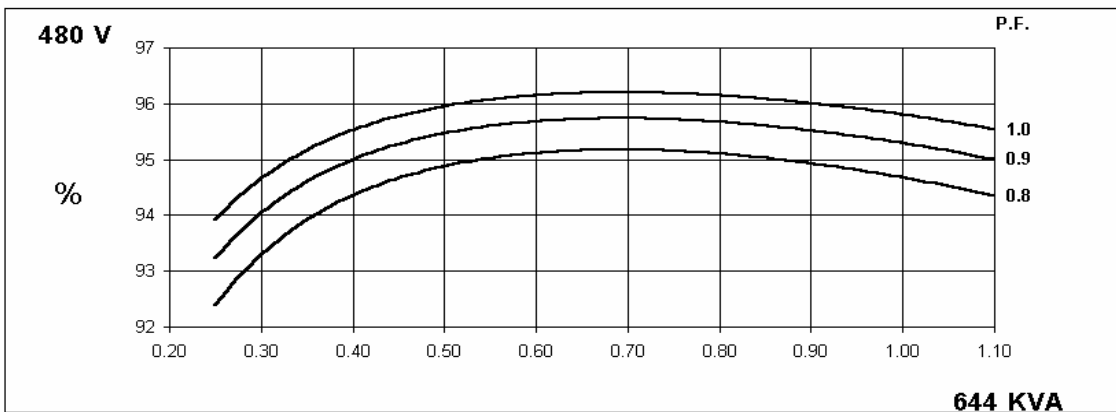
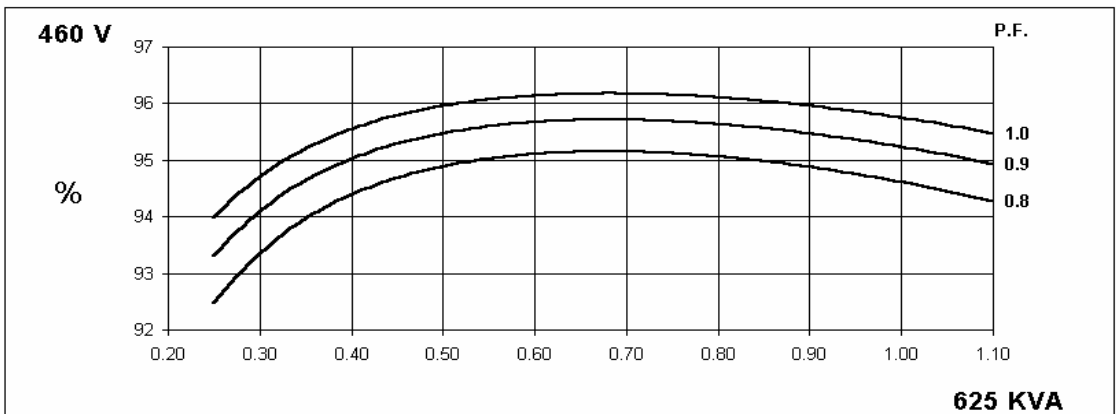
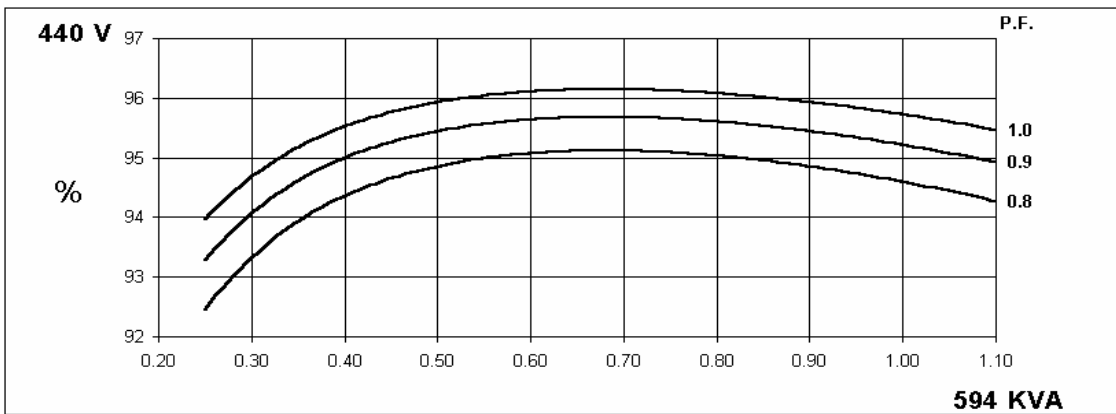
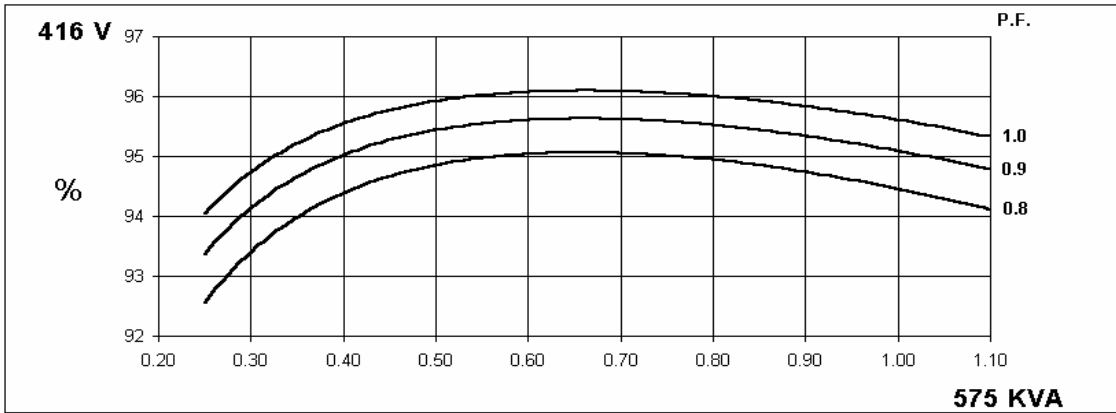

HCI534D/544D

Winding 311



Locked Rotor Motor Starting Curve

**50
Hz**

MX

SX

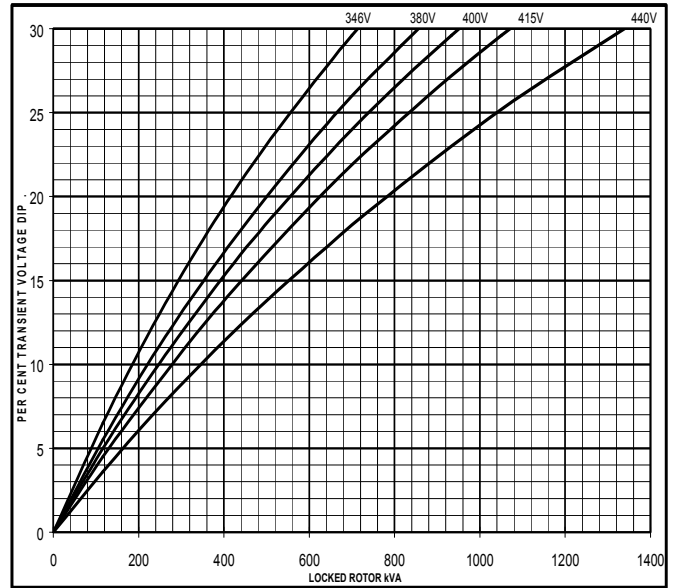
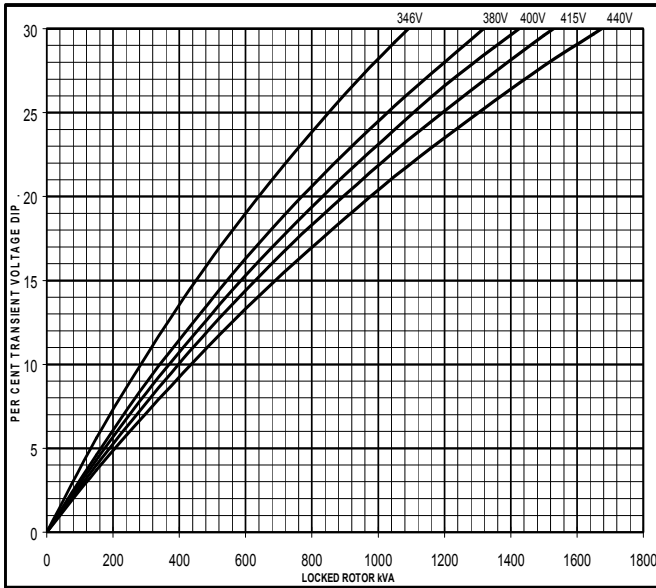

**60
Hz**

MX

SX

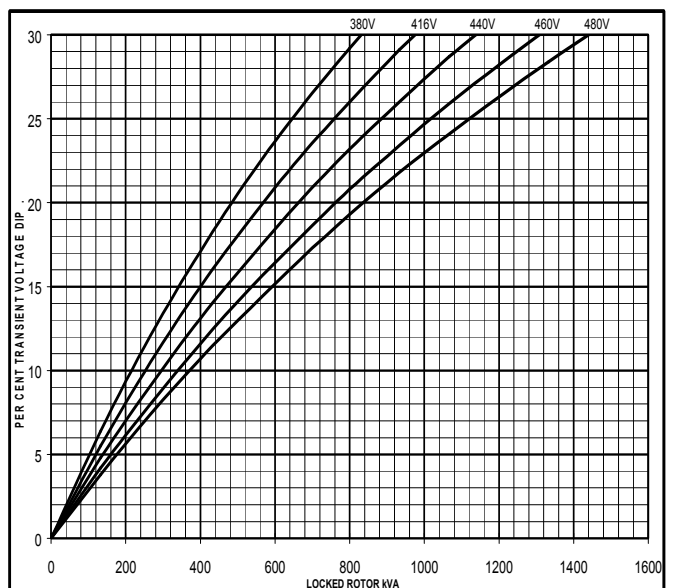
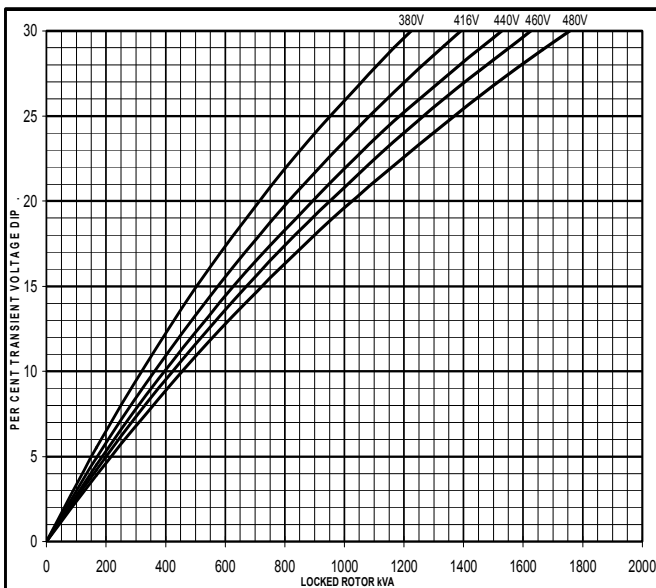

**Three-phase Short Circuit Decrement Curve. No-load Excitation at Rated Speed
Based on star (wye) connection.**

**50
Hz**

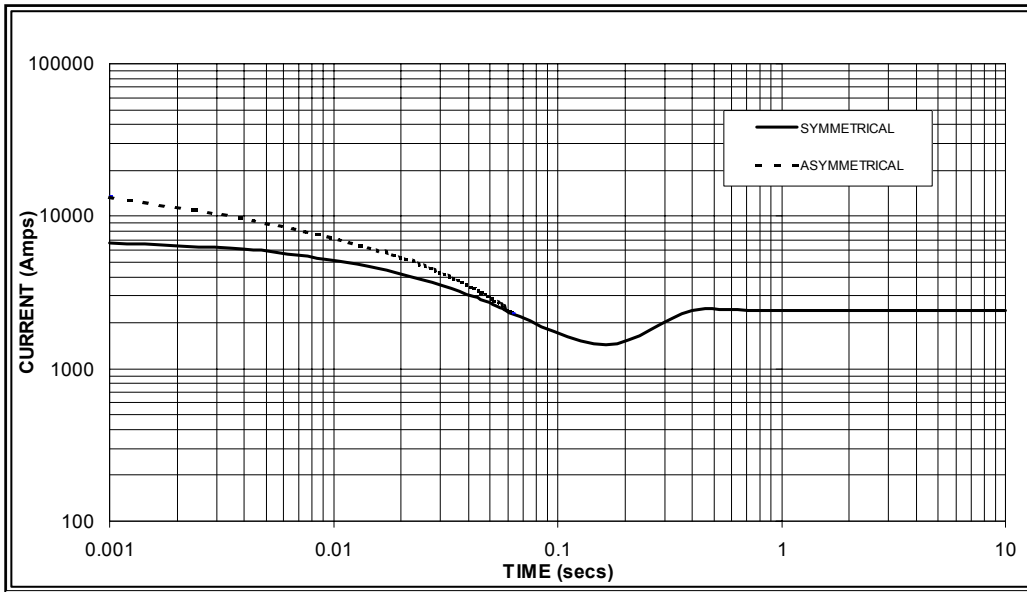

Sustained Short Circuit = 2,400 Amps

**60
Hz**

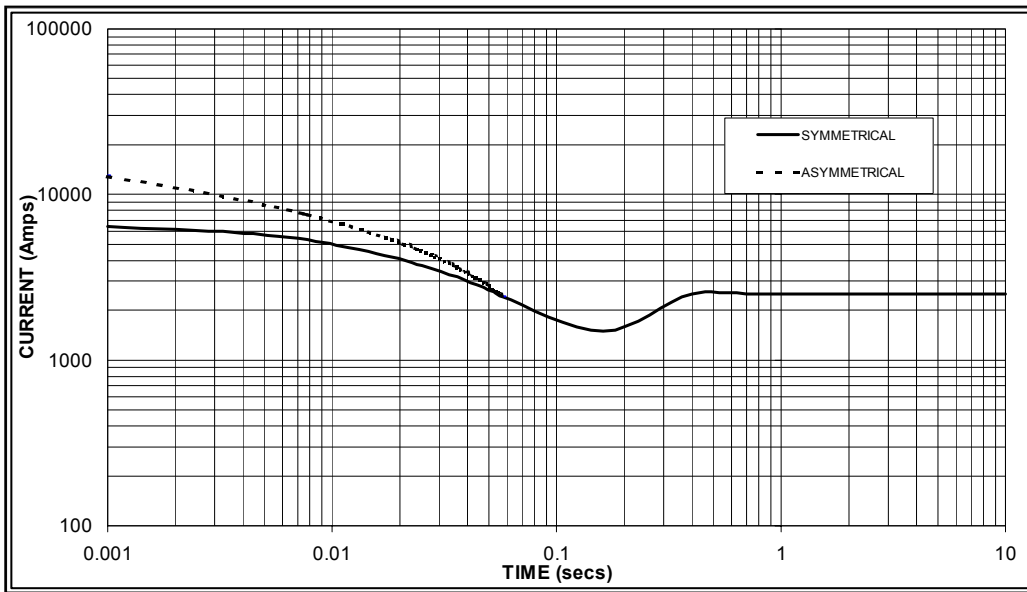

Sustained Short Circuit = 2,500 Amps

Note 1

The following multiplication factors should be used to adjust the values from curve between time 0.001 seconds and the minimum current point in respect of nominal operating voltage :

50Hz		60Hz	
Voltage	Factor	Voltage	Factor
380v	X 1.00	416v	X 1.00
400v	X 1.06	440v	X 1.06
415v	X 1.09	460v	X 1.12
440v	X 1.12	480v	X 1.20

The sustained current value is constant irrespective of voltage level

Note 2

The following multiplication factor should be used to convert the values calculated in accordance with NOTE 1 to those applicable to the various types of short circuit :

	3-phase	2-phase L-L	1-phase L-N
Instantaneous	x 1.00	x 0.87	x 1.30
Minimum	x 1.00	x 1.80	x 3.20
Sustained	x 1.00	x 1.50	x 2.50
Max. sustained duration	10 sec.	5 sec.	2 sec.

All other times are unchanged

Note 3

Curves are drawn for Star (Wye) connected machines. For other connection the following multipliers should be applied to current values as shown :

Parallel Star = Curve current value X 2

Series Delta = Curve current value X 1.732

HCI534D/544D
Winding 311 0.8 Power Factor

RATINGS

Class - Temp Rise	Cont. F - 105/40°C				Cont. H - 125/40°C				Standby - 150/40°C				Standby - 163/27°C				
50 Hz	Series Star (V)	380	400	415	440	380	400	415	440	380	400	415	440	380	400	415	440
	Parallel Star (V)	190	200	208	220	190	200	208	220	190	200	208	220	190	200	208	220
	Series Delta (V)	220	230	240	254	220	230	240	254	220	230	240	254	220	230	240	254
kVA	450	495	450	450	500	550	500	500	515	575	515	515	530	590	530	530	
kW	360	396	360	360	400	440	400	400	412	460	412	412	424	472	424	424	
Efficiency (%)	94.8	94.7	95.0	95.1	94.5	94.3	94.8	94.9	94.4	94.1	94.7	94.9	94.2	94.0	94.6	94.8	
kW Input	380	418	379	379	423	467	422	421	436	489	435	434	450	502	448	447	

60 Hz	Series Star (V)	416	440	460	480	416	440	460	480	416	440	460	480	416	440	460	480
	Parallel Star (V)	208	220	230	240	208	220	230	240	208	220	230	240	208	220	230	240
	Delta (V)	240	254	266	277	240	254	266	277	240	254	266	277	240	254	266	277
kVA	519	538	563	588	575	594	625	644	588	625	655	675	606	644	673	694	
kW	415	430	450	470	460	475	500	515	470	500	524	540	485	515	538	555	
Efficiency (%)	94.7	94.8	94.9	94.9	94.5	94.6	94.6	94.7	94.4	94.4	94.5	94.5	94.3	94.3	94.4	94.4	
kW Input	438	454	475	496	487	502	529	544	498	530	554	571	514	546	570	588	

DIMENSIONS

